

Products Catalog

## EMC/ESD Components

- Common mode Noise Filters
- ESD Suppressor
- Multilayer Varistor

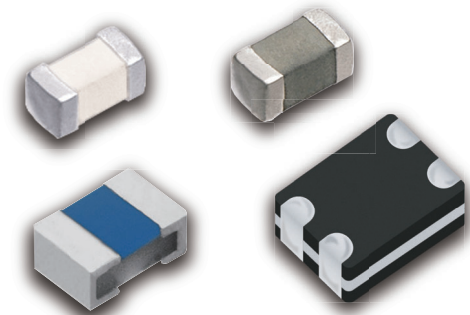

**IN Your  
Future**



# EMC components / ESD components contents INDEX

Classification	Product item	Size (mm)	Representative application	Part No.	Page	
Safety and Legal Matters to Be Observed					1	
Matters to Be Observed When Using This Product (Common Mode Noise Filters)					2	
EMC Components	Common Mode Noise Filters (For consumer)	0605	USB 3.2, HDMI 2.1	EXCX4CZ	4	
			USB 3.2/Gen 1, MIPI 3.0	EXCX4CH	6	
			USB 2.0, MIPI 1.1	EXCX4CE	8	
		0806	USB 3.2/Gen 1, HDMI 2.0	EXC14CH	10	
			LVDS, USB 2.0, MIPI 1.1	EXC14CE	12	
			HDMI 1.2, LVDS	EXC14CG <span style="background-color: #cccccc; padding: 2px;">NRFND</span>	14	
			MIPI 2.1	EXC14CT	16	
			MIPI 1.1	EXC14CX	18	
		0906	MIPI C-PHY 2.1	EXC16CT	20	
		1210	USB 3.2/Gen 2, HDMI 2.1	EXC24CK	22	
			USB 3.2/Gen 1, HDMI 2.0	EXC24CH	24	
			HDMI 1.2, LVDS	EXC24CG <span style="background-color: #cccccc; padding: 2px;">NRFND</span>	27	
			USB 2.0, LVDS	EXC24CE/CF	28	
		2012	USB 2.0, LVDS	EXC34CE	31	
	HDMI 1.2, LVDS		EXC34CG <span style="background-color: #cccccc; padding: 2px;">NRFND</span>	34		
	Common Mode Noise Filters Array (For consumer)	1608	LVDS	EXC18CE	36	
			HDMI 1.2, LVDS	EXC18CG <span style="background-color: #cccccc; padding: 2px;">NRFND</span>	38	
		2010	USB 3.2, HDMI 2.0	EXC28CH	40	
			HDMI 1.2, LVDS	EXC28CG <span style="background-color: #cccccc; padding: 2px;">NRFND</span>	42	
	Common Mode Noise Filters Array / Packaging methods, Land pattern and Soldering conditions					46
	<span style="background-color: #cccccc; padding: 2px;">NRFND</span>	0806	Mobile voice line	EXC14CP	48	
	2 Mode Noise Filters	1012	Mobile voice line	EXC24CB/CP/CN	50	
2 Mode Noise Filters / Packaging methods, Land pattern and Soldering conditions					53	
Common Mode Noise Filters / Performance					55	
Matters to Be Observed When Using This Product (ESD Suppressor)					56	
ESD Components	ESD Suppressor	1005/1608	Antenna/ Differential transmission line	EZAEG 2A, 3A	58	
		0603/1005	Antenna/ Differential transmission line	EZAEG 1N, 2N	60	
	ESD Suppressor Array	2012	Differential transmission line	EZAEG CA	62	
	ESD Suppressor high withstanding type	1608	Automotive antenna/ Differential transmission line	EZAEG 3W	64	
	ESD Suppressor Array / Packaging methods, Soldering conditions					66
	Matters to Be Observed When Using This Product (Multilayer Varistor : Automotive Grade)					67
	Multilayer varistor (Automotive grade)	1005/1608	Automotive transmission line/ power line	EZJZ-M / EZJP-M	74	
	Multilayer Varistor (Automotive Grade) / Characteristics, Performance, packaging					78
	Matters to Be Observed When Using This Product (Multilayer Varistor)					79
	Multilayer varistor (For ESD pulse)	1005/1608	Low capacitance type [High speed signal lines]	EZJZ	86	
	Multilayer varistor (For ESD pulse and surge protection)	1608/2012	Low voltage type (Standard type) [DC voltage lines/Low speed signal lines]	EZJZ	92	
	Multilayer varistor (For ESD pulse)	0603/1005/1608	Low voltage type (Standard type) [DC voltage lines / Low speed signal lines]	EZJP	95	
	Multilayer varistor (For ESD pulse)	1608/2012	DC voltage lines	EZJS	98	
	Multilayer Varistor / Characteristics, Applications, Performance, packaging					100

## Safety and Legal Matters to Be Observed

### Product specifications and applications

- Please be advised that this product and product specifications are subject to change without notice for improvement purposes. Therefore, please request and confirm the latest delivery specifications that explain the specifications in detail before the final design, or purchase or use of the product, regardless of the application. In addition, do not use this product in any way that deviates from the contents of the company's delivery specifications.
- Unless otherwise specified in this catalog or the product specifications, this product is intended for use in general electronic equipment (AV products, home appliances, commercial equipment, office equipment, information and communication equipment, etc.).  
When this product is used for the following special cases, the specification document suited to each application shall be signed/sealed (with Panasonic Industry and the user) in advance..These include applications requiring special quality and reliability, wherein their failures or malfunctions may directly threaten human life or cause harm to the human body (e.g.: space/aircraft equipment, transportation/traffic equipment, combustion equipment, medical equipment, disaster prevention/crime prevention equipment, safety equipment, etc.).

### Safety design and product evaluation

- Please ensure safety through protection circuits, redundant circuits, etc., in the customer's system design so that a defect in our company's product will not endanger human life or cause other serious damage.
- This catalog shows the quality and performance of individual parts. The durability of parts varies depending on the usage environment and conditions. Therefore, please ensure to evaluate and confirm the state of each part after it has been mounted in your product in the actual operating environment before use.  
If you have any doubts about the safety of this product, then please notify us immediately, and be sure to conduct a technical review including the above protection circuits and redundant circuits at your company.

### Laws / Regulations / Intellectual property

- The transportation of dangerous goods as designated by UN numbers, UN classifications, etc., does not apply to this product. In addition, when exporting products, product specifications, and technical information described in this catalog, please comply with the laws and regulations of the countries to which the products are exported, especially those concerning security export control.
- Each model of this product complies with the RoHS Directive (Restriction of the use of hazardous substances in electrical and electronic equipment) (2011/65/EU and (EU) 2015/863). The date of compliance with the RoHS Directive and REACH Regulation varies depending on the product model.  
Further, if you are using product models in stock and are not sure whether or not they comply with the RoHS Directive or REACH Regulation, please contact us by selecting "Sales Inquiry" from the inquiry form.
- During the manufacturing process of this product and any of its components and materials to be used, Panasonic Industry does not intentionally use ozone-depleting substances stipulated in the Montreal Protocol and specific bromine-based flame retardants such as PBBs (Poly-Brominated Biphenyls) / PBDEs (Poly-Brominated Diphenyl Ethers). In addition, the materials used in this product are all listed as existing chemical substances based on the Act on the Regulation of Manufacture and Evaluation of Chemical Substances.
- With regard to the disposal of this product, please confirm the disposal method in each country and region where it is incorporated into your company's product and used.
- The technical information contained in this catalog is intended to show only typical operation and application circuit examples of this product. This catalog does not guarantee that such information does not infringe upon the intellectual property rights of Panasonic Industry or any third party, nor imply that the license of such rights has been granted.
- Design, materials, or process related to technical owned by Panasonic Industry are subject to change without notice.

**Panasonic Industry will assume no liability whatsoever if the use of our company's products deviates from the contents of this catalog or does not comply with the precautions. Please be advised of these restrictions.**

## Matters to Be Observed When Using This Product

(Common mode noise filter)

### Use environments and cleaning conditions

- This product is not designed for use in specific environments. Using this product in the following specific environments or service conditions may affect the performance/reliability of this product. Avoid using it in such specific environments. If you intend to use this product in such environments, checking the performance, reliability, etc., of the product sufficiently is your own responsibility.
  - (1) Used in liquid, such as water, oil, chemicals, and organic solvents.
  - (2) Used in a place exposed to direct sunlight, an outdoor place with no shielding, or a dusty place.
  - (3) Used in a place where the product is heavily exposed to sea breeze or a corrosive gas, such as Cl<sub>2</sub>, H<sub>2</sub>S, NH<sub>3</sub>, SO<sub>2</sub>, or NO<sub>x</sub>.
  - (4) Used in an environment where static electricity and electromagnetic waves are strong.
  - (5) Located close to a heating component or a flammable material, such as a vinyl cable placed near the product.
  - (6) Sealed or coated with a resin.
  - (7) Solder flux of this product soldered with no-clean type solder, etc., is cleansed with a solvent, water, or a water-soluble cleaner, etc. (Water-soluble flux residues have a particularly large influence on this product.)
  - (8) Used in a place where dew concentrates on the product.
  - (9) Used in a contaminated state.

(Example: Touching this product mounted on a printed circuit board with sebum still attached. (improper handling))
- Sealing this product with a resin in a resin potting process, damp-proofing process, etc., applies excessive stress to this product, which may cause the internal electrodes a connection problem. In such cases, the proper operation of this product is not guaranteed. If you intend to use this product in such environments, checking the performance, reliability, etc., of the product sufficiently is your own responsibility.
- Do not leave this product immersed in a solvent for a long time. When using this product immersed in a solvent, confirm the operation of the product mounted on the board.
- When a cleaning solution or cleaning condition for cleaning the printed board or a drying condition for drying the printed board after soldering this product is improper, it may have a negative effect on the performance/reliability of this product. Confirming these conditions sufficiently is your own responsibility. Also examine the effects of soiled cleaning agent, cleaning residues, and post-cleaning contaminations, and control for these effects properly.

### Response to anomalies and handling conditions

- When this product is heating abnormally or emitting a smell, stop using this product immediately, for example, turn off the main power supply of the device.

Also, keep your face and hands away from the product as it may become hot and cause burns.
- This product is so thin that it may break easily when subjected to impact. Before putting this product in use, confirm that this product has not been broken by impact that applied thereto when mounted on the printed board. Applying impact to this product or pinching this product with a hard tool (pliers, tweezers, etc.) may chip this product or its protective film, which affects its performance. Be careful to avoid such cases.
- Do not reuse this product having been used on a printed board and removed therefrom. Do not touch this product with your bare hands.
- Be careful not to drop this product on the floor, etc. This product is likely to suffer mechanical or electrical damage when dropped on the floor. Avoid using said this product.
- This product may have its characteristics value changed due to electrostatic discharge (ESD). Take ESD prevention measures when handling this product. ESD prevention measures include an environment where static electricity is not likely to be generated (recommended RH: 40% to 60%), by wearing an earth band, conductive gloves, etc., grounding the device in which this product is incorporated, and placing a conductive mat, etc., on a work platform.
- It is guaranteed that this product not exposed to any stress will have its proper characteristics value. Any stress or pressure applied to this product may cause its characteristics value to change. Examine and evaluate the characteristics of this product sufficiently before using it.

## Reliability and product life

A product conforming to "AEC-Q200" refers to a product having passed some or all of the evaluation test items defined in AEC-Q200. To know the detailed specifications of individual products or specific evaluation test scores, please contact us. We issue a delivery specification sheet for each product ordered. Please confirm with the sheet when you place an order with us.

## Circuit design and circuit board design

- To prevent a case where a transient load (e.g., a pulse applied for a short period) too large for the filter to handle is applied to the filter, make sure to evaluate and confirm the operation of the filter incorporated in your product. Applying a voltage or current larger than the rated voltage or current to the filter may impair its performance and reliability. Make sure to use the filter with voltage or current equal to or lower than the rated voltage or current. The product warranty does not cover usage where an excessively large load, such as a pulse current, is applied to the product.
- Be careful that unusual stress caused by an excessive bend of the printed board is not applied to this product. Design the circuit structure such that this product is not close to a perforated line for board splitting or on a line with sizable holes bored on the board.
- When a different component is mounted on the board where this product has been soldered, be careful that the board does not bend excessively. If necessary, provide the board with backup pins (support pins) to keep it straight.
- Avoid manual board splitting. Use a jig, etc., to break the board so that it does not bend excessively when split apart.

## Mounting conditions

- When the product is used under mounting conditions departing from mounting conditions specified in our specification sheet, the product may be exposed to unexpected stress to fail. Be careful to avoid such a case. Make sure to evaluate and confirm the operation of the filter incorporated in your product and determine whether the filter is usable as a component of the product.
- Set soldering conditions for this product within the recommended soldering conditions specified by our company. Any time, soldering condition departing from the specified soldering condition, such as a high peak temperature or a long heating may impair the performance/reliability of this product. Note that the specified soldering conditions indicate conditions under which degradation of this product characteristics does not occur but do not indicate conditions under which stable soldering can be performed. Check and set individual conditions under which stable soldering can be performed.
- Heat this product in advance so that a difference between the soldering temperature and the temperature of this product surface is reduced to 100 °C or lower. When dipping the soldered product in a solvent, etc., to cool this product rapidly, ensure that the temperature difference between this product and the solvent is 100 °C or lower during the dipping.
- When soldering the filter using a soldering iron, apply hot air, etc., to the filter to heat it sufficiently in advance and then solder the filter without bringing the soldering iron tip into contact with the product. If the temperature of the soldering iron tip is high, finish the soldering work quickly (within 3 seconds when the temperature of the soldering iron tip is 350°C or lower). The volume of solder (fillet size) used when mounting the filter on the board may affect the performance of the filter. Make sure to confirm the solder volume of the soldering work on the actual product.
- Soldering this product with too much solder or too little solder results in the poor reliability of the solder connection of this product. Use the proper volume of solder in the soldering process. Sufficiently check for the volume of solder used.
- Soldering with high bond strength or special property solder may affect the quality of this product. Do not use such solder.
- Use rosin-based solder flux. When using highly active solder flux made mainly of halogen (chlorine, bromine, etc.), flux residues may affect the performance and reliability of this product. Check the effects of flux residues before using the solder flux. Do not use highly acidic flux, water-soluble flux, or flux containing fluoride ions. When solder flux sticks to this product after the soldering process, the activation energy of the flux may corrode this product and cause it to fail. Prevent solder flux from sticking to this product.

## Storage conditions

Keeping the product in the following environments or conditions may lead to degradation of its performance, solderability, etc. Do not keep the product in the following environments.

- (1) Stored in a place where the product is heavily exposed to sea breeze or a corrosive gas, such as Cl<sub>2</sub>, H<sub>2</sub>S, NH<sub>3</sub>, SO<sub>2</sub>, or NO<sub>x</sub>.
- (2) Stored in a place where the product is exposed to direct sunlight.
- (3) Stored in a place where a temperature condition of 5 °C to 35 °C and a relative humidity condition of 45% to 85% cannot be maintained.
- (4) Kept in storage for more than one year from the delivery date (when the product is kept in conditions excluding any of the environments (1) to (3)).

## Common Mode Noise Filters

### EXCX4CZ type



#### Features

- Small and thin (L 0.65 mm×W 0.50 mm×H 0.30 mm)
- High-common mode attenuation at 2.4GHz or higher, Suitable for noise suppression at Wi-Fi band
- Strong multilayer/sintered structure, excellent reflow resistance and high mounting reliability
- Lead, halogen and antimony-free
- RoHS compliant

#### Recommended applications

- Smartphones, Tablet PCs and DSC
- Suppresses noise radiation to Wi-Fi Equipment

#### Explanation of part numbers

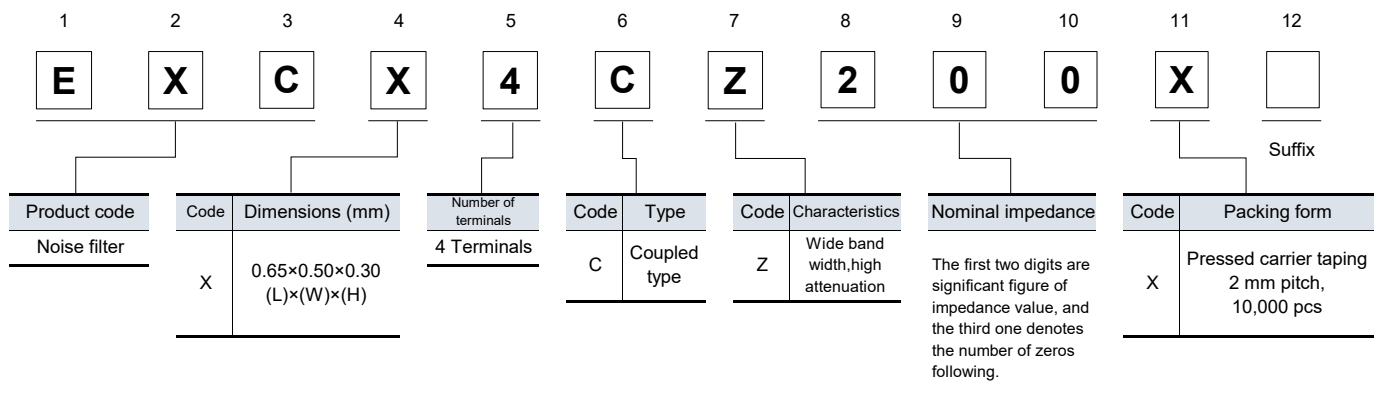

#### Construction

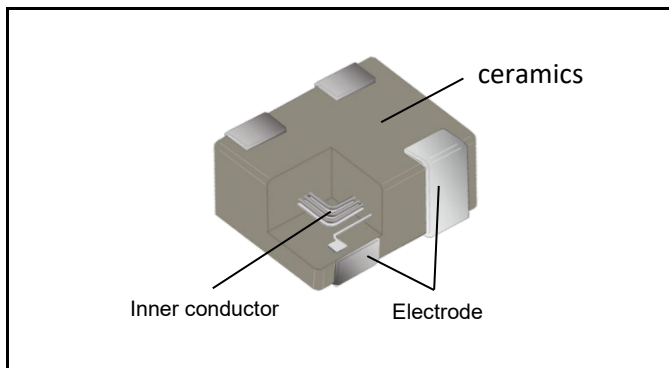

#### Circuit configuration (No polarity)

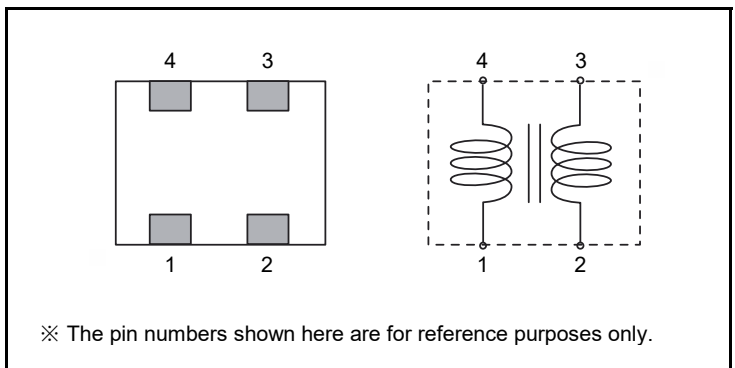

#### Dimensions in mm (not to scale)

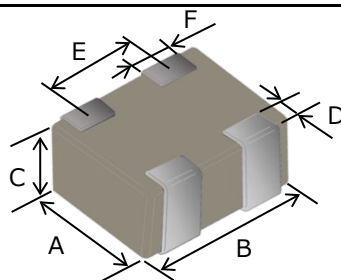

Unit : mm

Part No. (inch size)	Dimensions						Mass (Weight) (mg/ pc.)
	A	B	C	D	E	F	
EXCX4CZ (0202)	0.50 ± 0.05	0.65 ± 0.05	0.30 ± 0.05	0.12 ± 0.10	0.40 ± 0.10	0.15 ± 0.10	0.22

**Ratings**

Part number	Impedance ( $\Omega$ ) at 100 MHz	Rated voltage (V) DC	Rated current (mA) DC	DC resistance ( $\Omega$ )
	Common mode			
EXCX4CZ040X	$4 \Omega \pm 2 \Omega$	5	100	$1.0 \pm 30 \%$
EXCX4CZ090X	$9 \Omega \pm 3 \Omega$	5	100	$1.9 \pm 30 \%$
EXCX4CZ200X	$20 \Omega \pm 30 \%$	5	100	$3.0 \pm 30 \%$

● Category temperature range  $-40 \text{ }^\circ\text{C}$  to  $+85 \text{ }^\circ\text{C}$

**Characteristics graph (Reference data)**

● EXCX4CZ040X

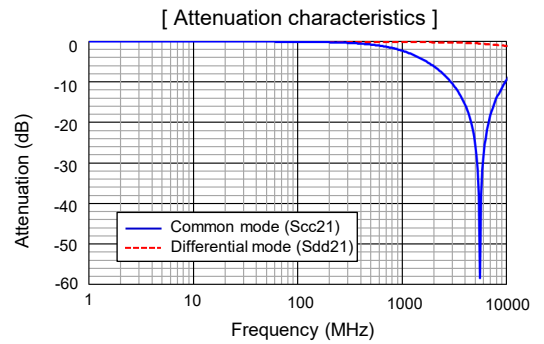
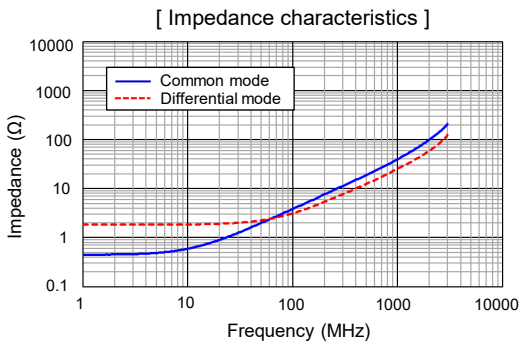

● EXCX4CZ090X

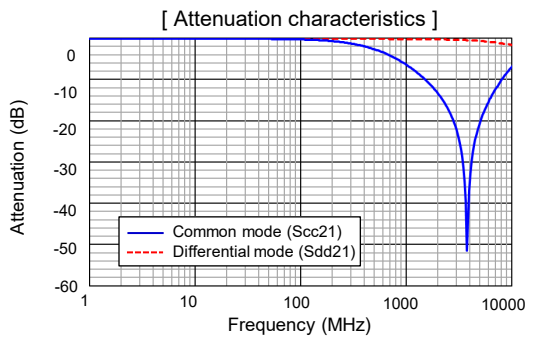
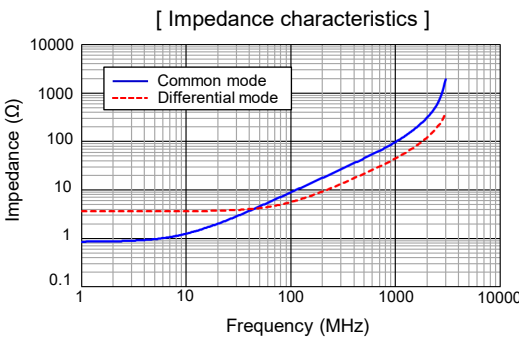

● EXCX4CZ200X

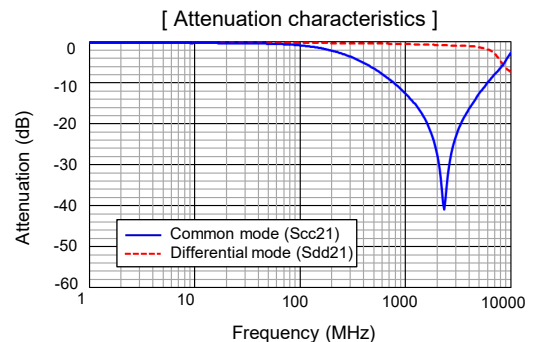
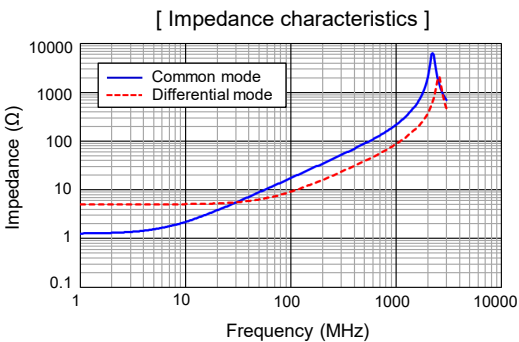

● Impedance measurement circuit

(A) Common mode

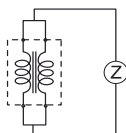

(B) Differential mode

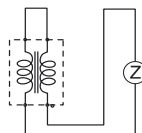

■ As for packaging methods, soldering conditions and safety precautions, please see data files

## Common Mode Noise Filters

### EXCX4CH type

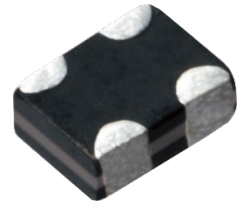

#### Features

- Small and thin (L 0.65 mm×W 0.50 mm×H 0.30 mm)
- High common mode attenuation in high-speed differential transmission lines, Cut-off frequency is more than 8.5 GHz, and an influence to differential transmission signal quality is little
- Strong multilayer/sintered structure, excellent reflow resistance and high mounting reliability
- Lead, halogen and antimony-free
- RoHS compliant

#### Recommended applications

- Smartphones, Tablet PCs and DSC
- Noise suppression of high-speed differential data lines such as USB, LVDS and HDMI

#### Explanation of part numbers

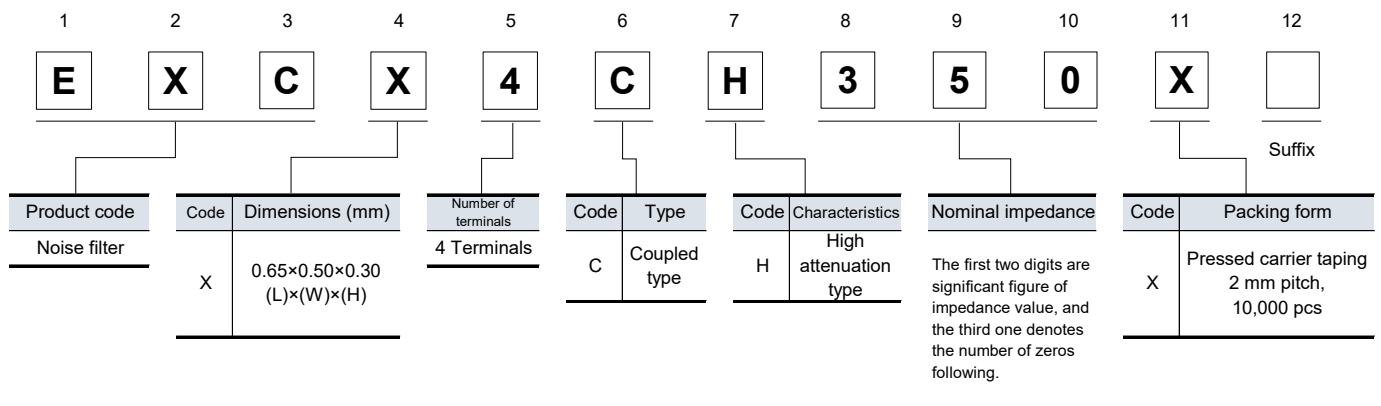

#### Construction

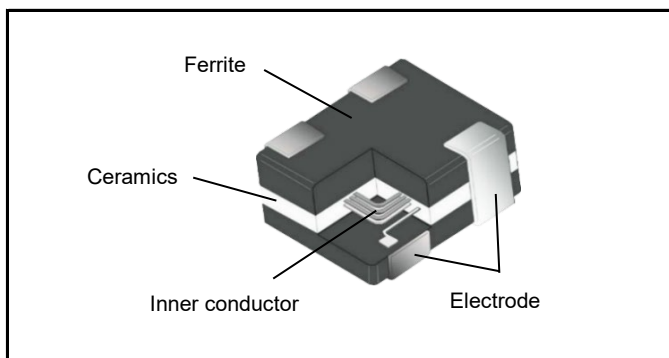

#### Circuit configuration (No polarity)

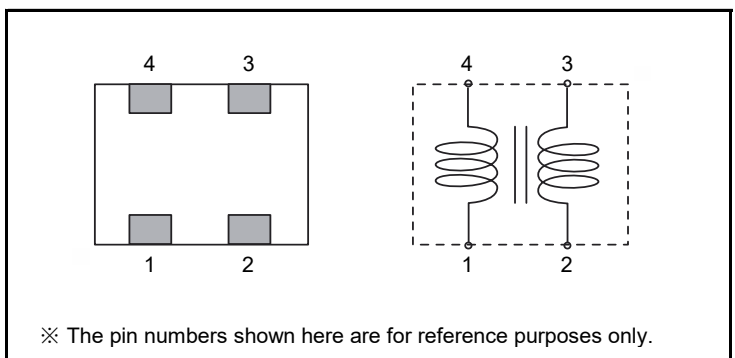

#### Dimensions in mm (not to scale)

Part No. (inch size)	Dimensions						Mass (Weight) (mg/ pc.)
	A	B	C	D	E	F	
EXCX4CH (0202)	0.50±0.05	0.65±0.05	0.30±0.05	0.12±0.10	0.40±0.10	0.15±0.10	0.43

Unit : mm

**Ratings**

Part number	Impedance ( $\Omega$ ) at 100 MHz		Rated voltage (V) DC	Rated current (mA) DC	DC resistance ( $\Omega$ ) max.
	Common mode				
EXCX4CH120X	12 $\Omega$ ±5 $\Omega$		5	100	2.0
EXCX4CH350X	35 $\Omega$ ±30 %		5	100	2.7

● Category temperature range -40 °C to +85 °C

**Characteristics graph (Reference data)**

● EXCX4CH120X

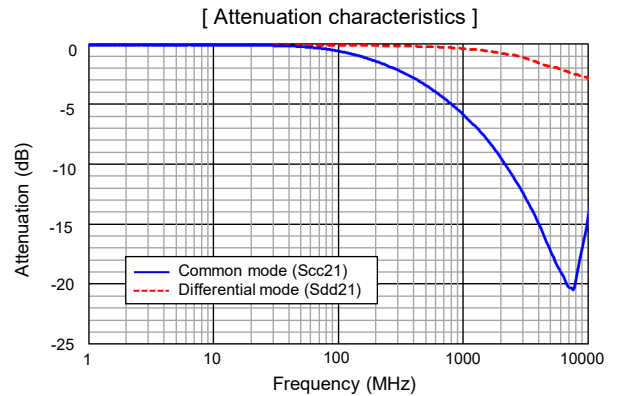
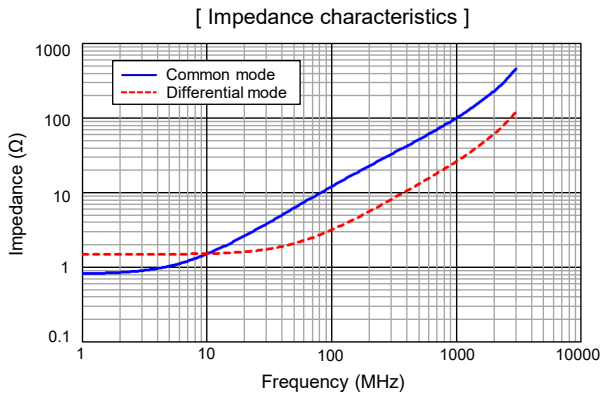

● EXCX4CH350X

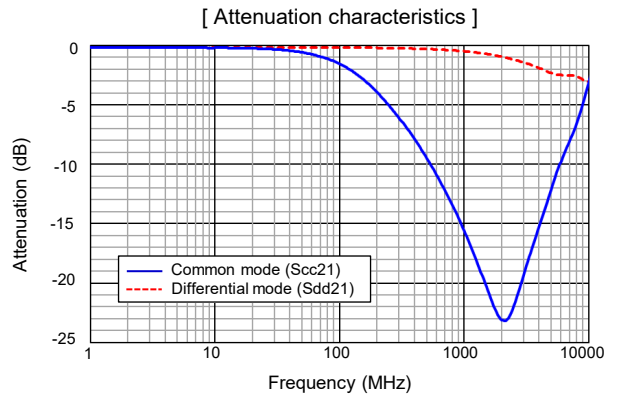
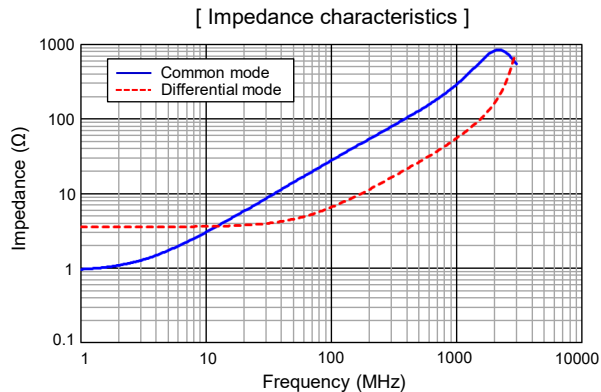

● Impedance measurement circuit

(A) Common mode

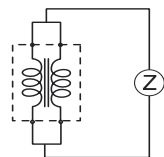

(B) Differential mode

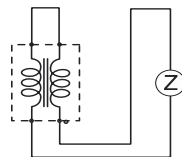

■ As for packaging methods, soldering conditions and safety precautions, please see data files

# Common Mode Noise Filters

## EXCX4CE type



### Features

- Small and thin (L 0.65 mm×W 0.50 mm×H 0.30 mm)
- Noise suppression of high-speed differential transmission lines with little influence of waveform rounding on signal transmission
- Strong multilayer/sintered structure, excellent reflow resistance and high mounting reliability
- Lead, halogen and antimony-free
- RoHS compliant

### Recommended applications

- Smartphones, Tablet PCs and DSC
- Noise suppression of high-speed differential data lines such as MIPI, USB and LVDS

### Explanation of part numbers

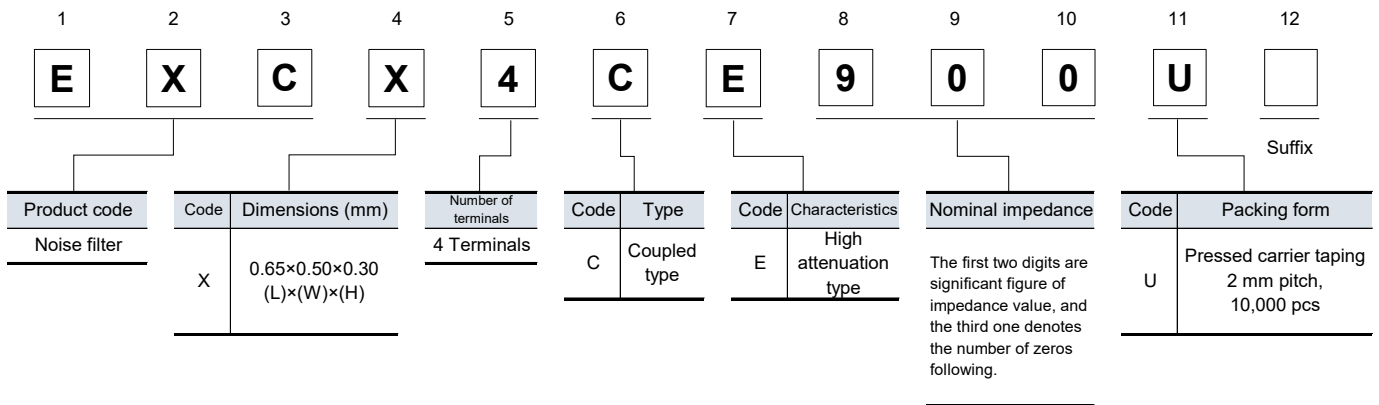

### Construction

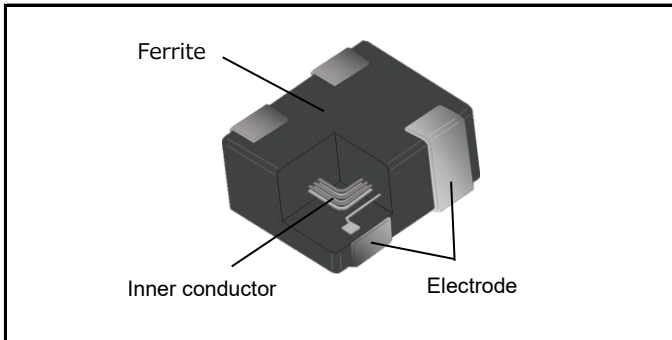

### Circuit configuration (No polarity)

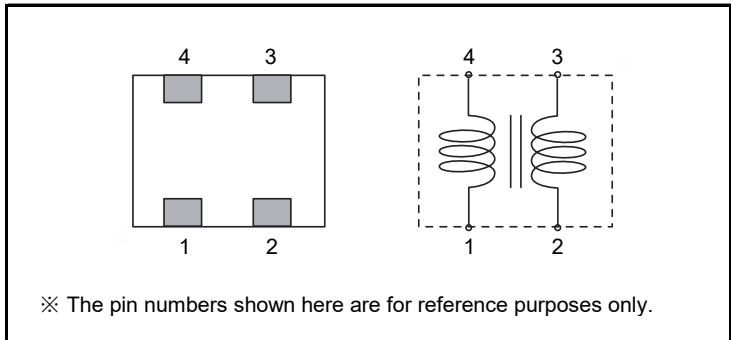

### Dimensions in mm (not to scale)

Part No. (inch size)	Dimensions						Mass (Weight) (mg/ pc.)
	A	B	C	D	E	F	
EXCX4CE (0202)	0.50 ± 0.05	0.65 ± 0.05	0.30 ± 0.05	0.12 ± 0.10	0.40 ± 0.10	0.15 ± 0.10	0.56

Unit : mm

**Ratings**

Part number	Impedance ( $\Omega$ ) at 100 MHz		Rated voltage (V) DC	Rated current (mA) DC	DC resistance ( $\Omega$ )
	Common mode	Differential mode			
EXCX4CE600U	60 $\Omega \pm 20 \%$	18 $\Omega$ max.	5	100	2.4 $\pm 30 \%$
EXCX4CE900U	90 $\Omega \pm 20 \%$	20 $\Omega$ max.	5	100	3.0 $\pm 30 \%$

● Category temperature range  $-40\text{ }^{\circ}\text{C}$  to  $+85\text{ }^{\circ}\text{C}$

**Characteristics graph (Reference data)**

● EXCX4CE600U

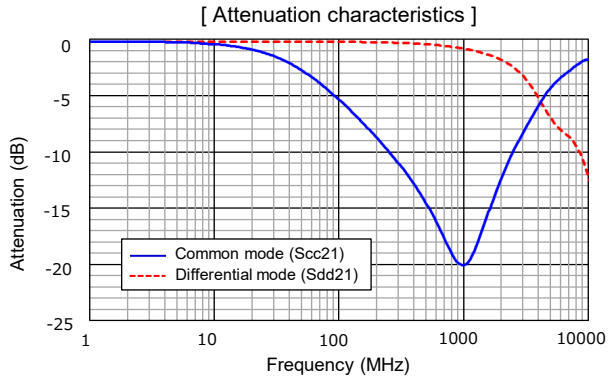
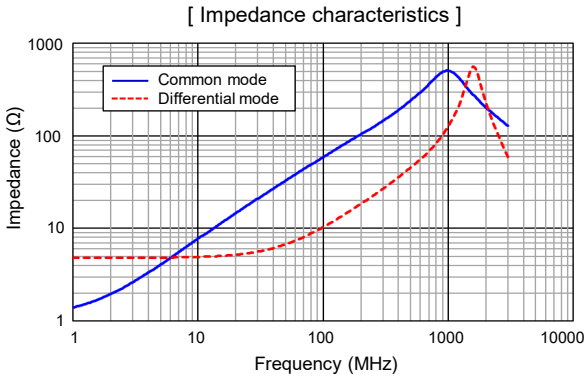

● EXCX4CE900U

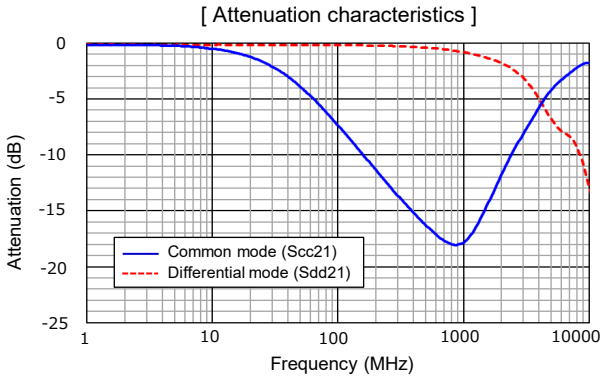
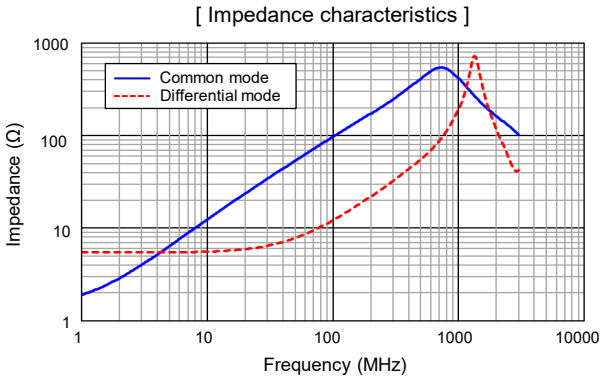

● Impedance measurement circuit

(A) Common mode

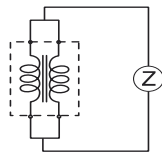

(B) Differential mode

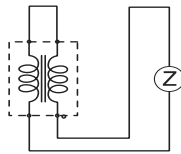

■ As for packaging methods, soldering conditions and safety precautions, please see data files

## Common Mode Noise Filters

### EXC14CH type

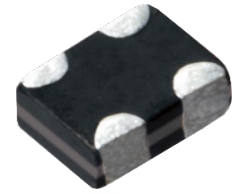

#### Features

- Small and thin (L 0.85 mm×W 0.65 mm×H 0.45 mm)
- High common mode attenuation in high-speed differential transmission lines, Cut-off frequency is more than 8.5 GHz, and an influence to differential transmission signal quality is little
- Strong multilayer/sintered structure, excellent reflow resistance and high mounting reliability
- RoHS compliant

#### Recommended applications

- Smartphones, Tablet PCs and DSC
- Noise suppression of high-speed differential data lines such as USB, LVDS and HDMI

#### Explanation of part numbers

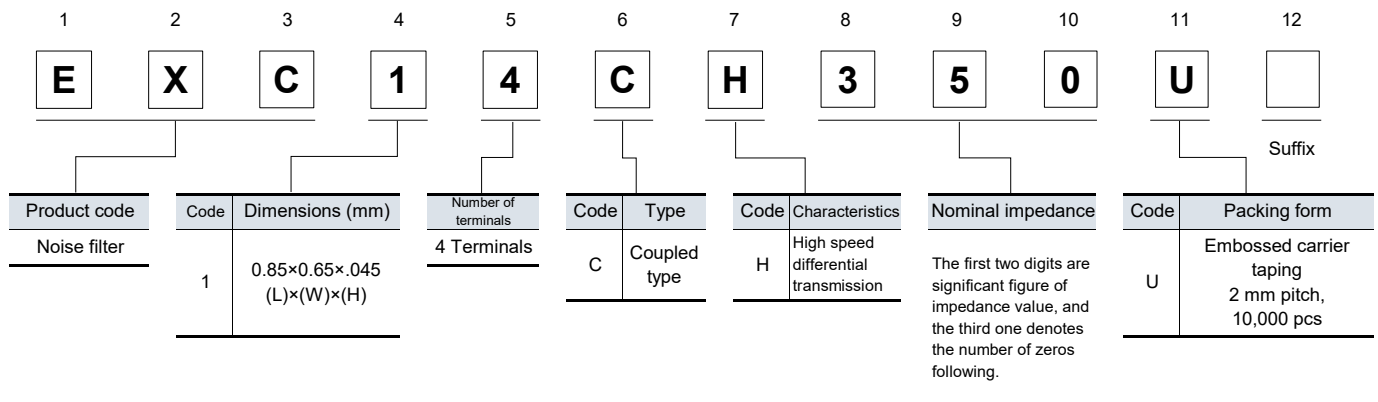

#### Construction

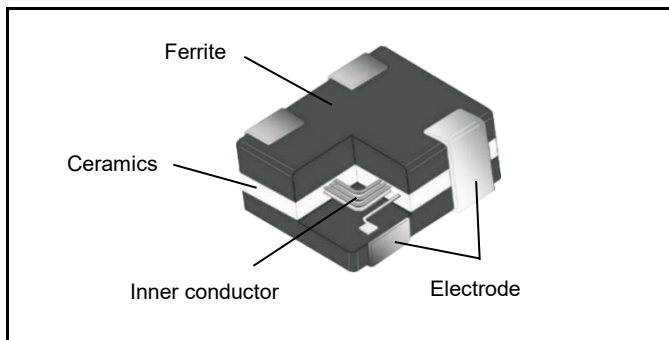

#### Circuit configuration (No polarity)

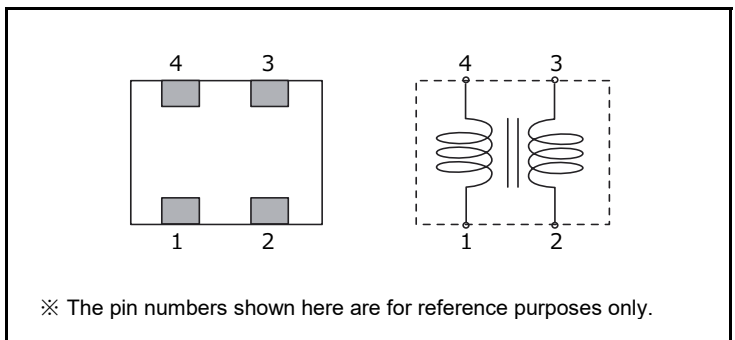

#### Dimensions in mm (not to scale)

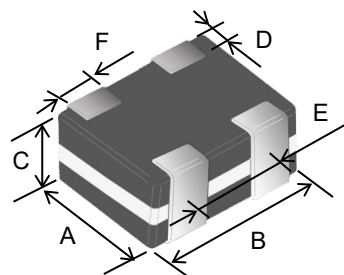

Unit : mm

Part No. (inch size)	Dimensions						Mass (Weight) (mg/ pc.)
	A	B	C	D	E	F	
EXC14CH (0302)	0.65 ± 0.05	0.85 ± 0.05	0.45 ± 0.05	0.10 min.	0.50 ± 0.10	0.27 ± 0.10	1.0

**Ratings**

Part number	Impedance ( $\Omega$ ) at 100 MHz		Rated voltage (V) DC	Rated current (mA) DC	DC resistance ( $\Omega$ ) max.
	Common mode	Differential mode			
EXC14CH120U	$12 \Omega \pm 5 \Omega$	10 $\Omega$ max.	5	100	1.0
EXC14CH350U	$35 \Omega \pm 30 \%$	15 $\Omega$ max.	5	100	1.5

● Category temperature range  $-40 \text{ }^\circ\text{C}$  to  $+85 \text{ }^\circ\text{C}$

**Characteristics graph (Reference data)**

● EXC14CH120U

[ Impedance characteristics ]

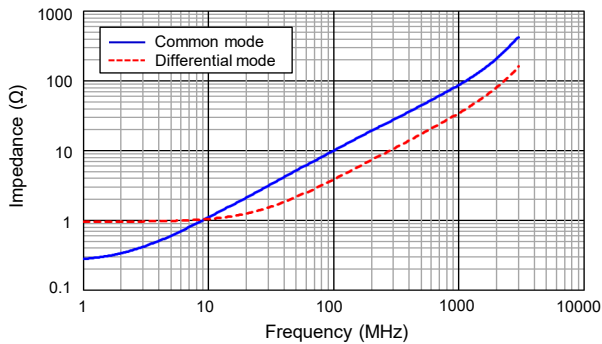

[ Attenuation characteristics ]

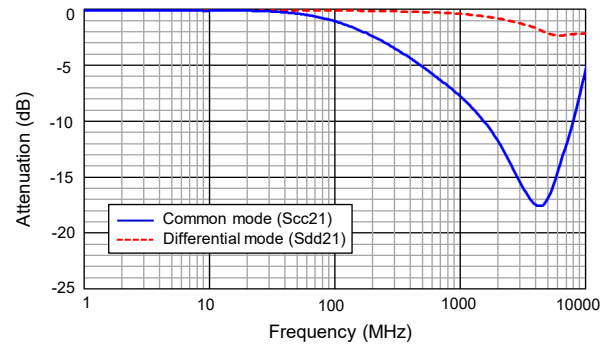

● EXC14CH350U

[ Impedance characteristics ]

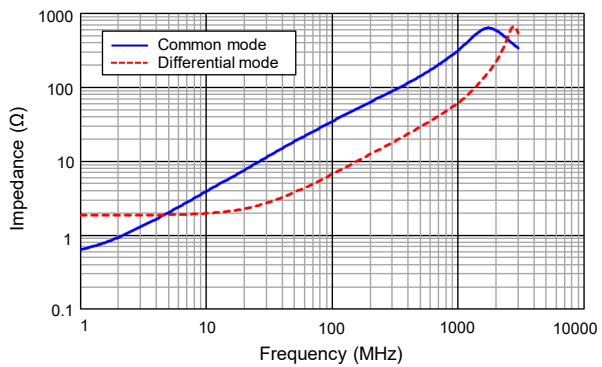

[ Attenuation characteristics ]

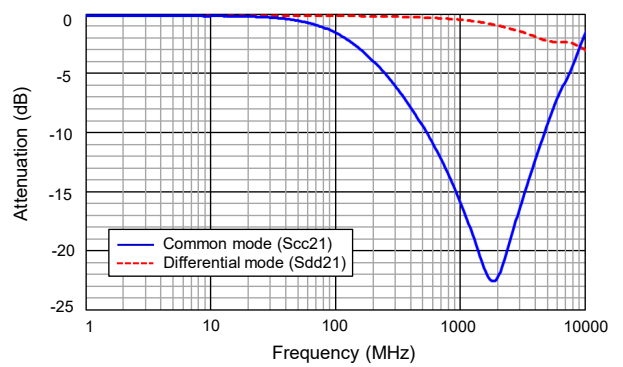

● Impedance measurement circuit

(A) Common mode

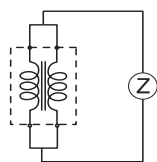

(B) Differential mode

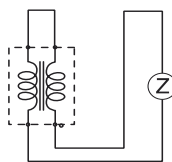

■ As for packaging methods, soldering conditions and safety precautions, please see data files

## Common Mode Noise Filters

### EXC14CE type



#### Features

- Small and thin (L 0.85 mm×W 0.65 mm×H 0.45 mm)
- Noise suppression of high-speed differential transmission lines with little influence of waveform rounding on signal transmission
- Low DC resistance and low insertion loss
- Strong multilayer/sintered structure, excellent reflow resistance and high mounting reliability
- RoHS compliant

#### Recommended applications

- Smartphones, Tablet PCs and DSC
- Noise suppression of high-speed differential data lines such as USB, LVDS, MIPI and MHL

#### Explanation of part numbers

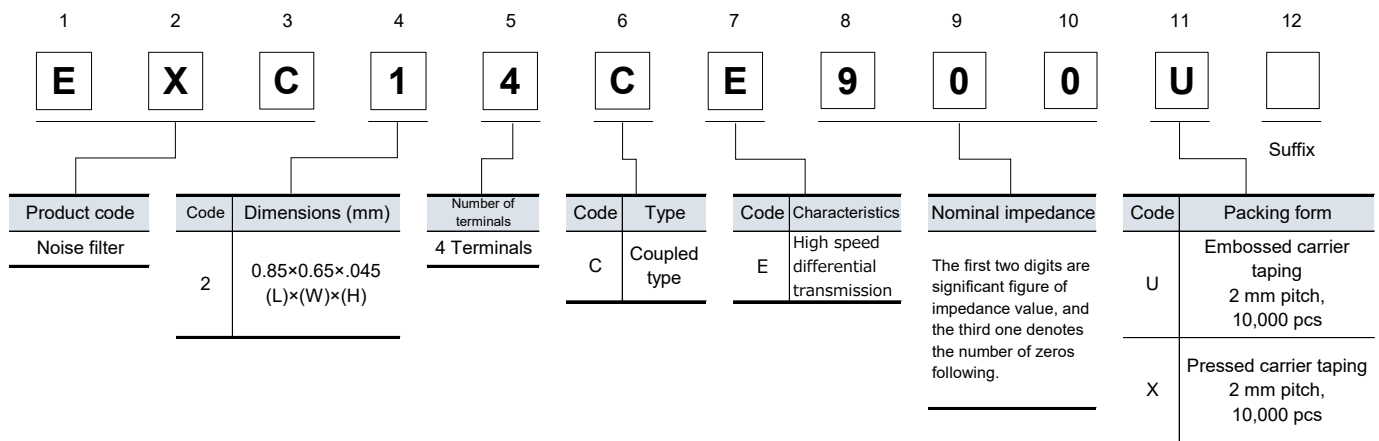

#### Construction

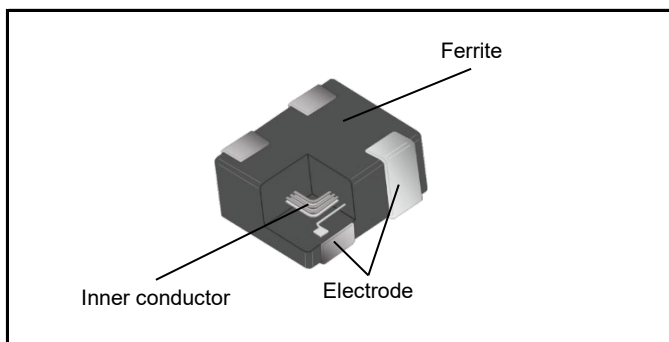

#### Circuit configuration (No polarity)

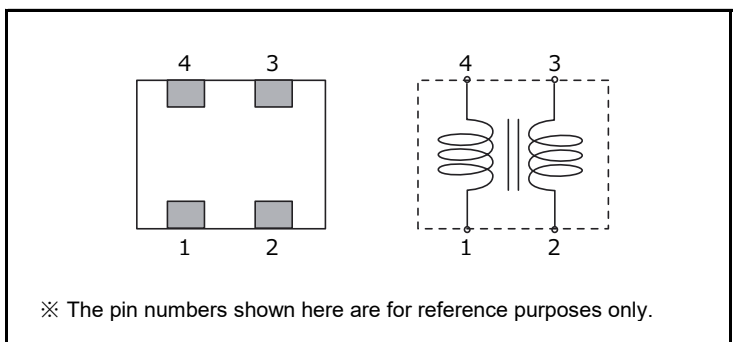

#### Dimensions in mm (not to scale)

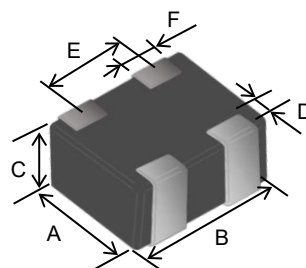

Part No. (inch size)	Dimensions						Mass (Weight) (mg/ pc.)
	A	B	C	D	E	F	
EXC14CE(0302)	0.65 ± 0.05	0.85 ± 0.05	0.45 ± 0.05	0.10 min.	0.50 ± 0.10	0.27 ± 0.10	1.4

**Ratings**

Part number	Impedance ( $\Omega$ ) at 100 MHz		Rated voltage (V) DC	Rated current (mA) DC	DC resistance ( $\Omega$ ) max.
	Common mode	Differential mode			
EXC14CE650U/X	65 $\pm$ 20 %	20 max.	5	130	2.5
EXC14CE900U/X	90 $\pm$ 20 %	20 max.	5	130	2.5
EXC14CE121U/X	120 $\pm$ 20 %	20 max.	5	100	3.8

● Category temperature range  $-40\text{ }^{\circ}\text{C}$  to  $+85\text{ }^{\circ}\text{C}$

**Characteristics graph (Reference data)**

● EXC14CE650U/X

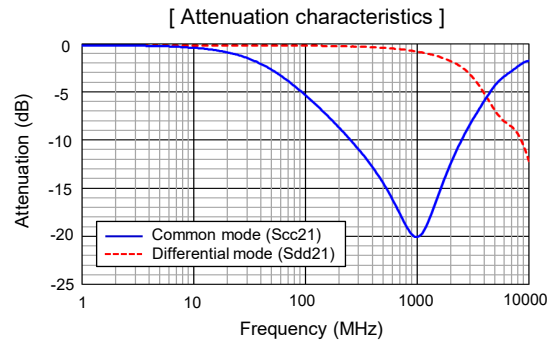
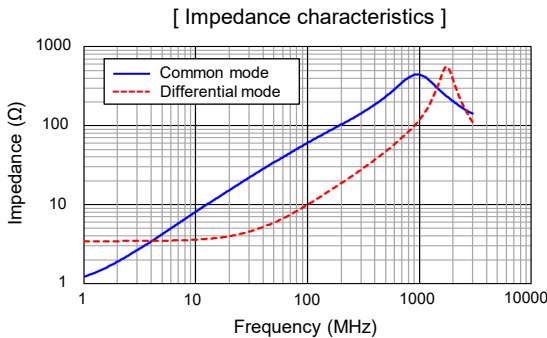

● EXC14CE900U/X

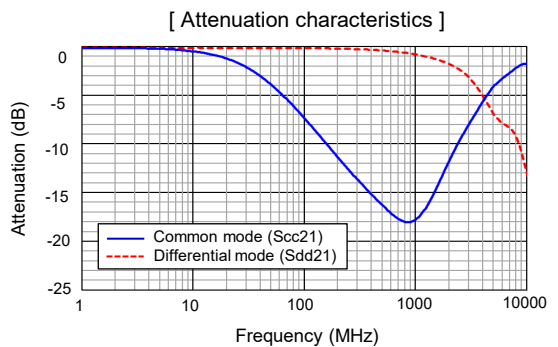
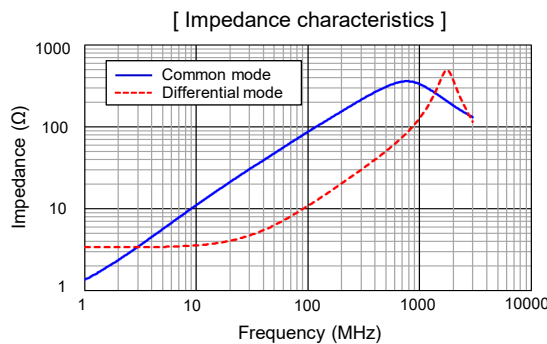

● EXC14CE121U/X

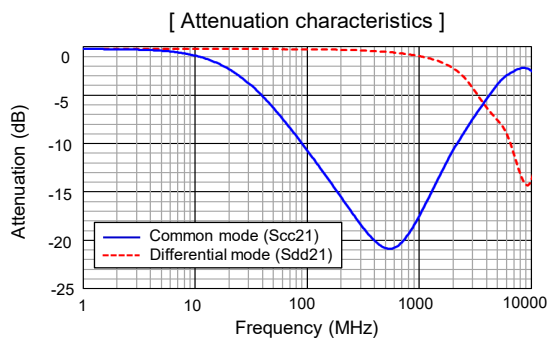
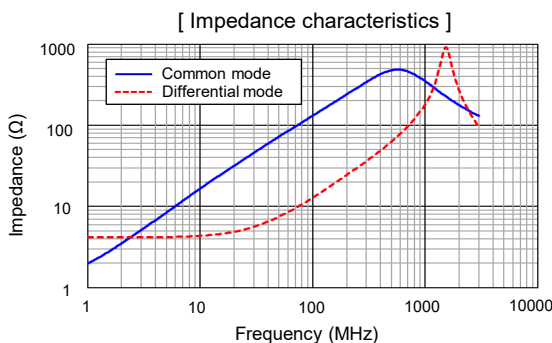

● Impedance measurement circuit

(A) Common mode

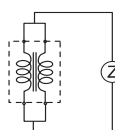

(B) Differential mode

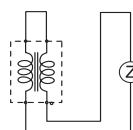

■ As for packaging methods, soldering conditions and safety precautions, please see data files

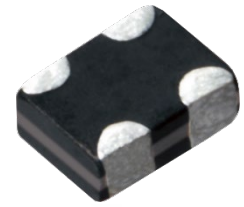

## Common Mode Noise Filters

### EXC14CG type

#### Features

- Small and thin (L 0.85 mm×W 0.65 mm×H 0.45 mm)
- Noise suppression of high-speed differential transmission lines with little influence of waveform rounding on signal transmission
- Low DC resistance and low insertion loss
- High-Q value and high impedance of GHz zone
- Strong multilayer/sintered structure, excellent reflow resistance and high mounting reliability
- RoHS compliant

#### Recommended applications

- Smartphones, Tablet PCs and DSC
- Noise suppression of high-speed differential data lines such as USB, LVDS and MHL

#### Explanation of part numbers

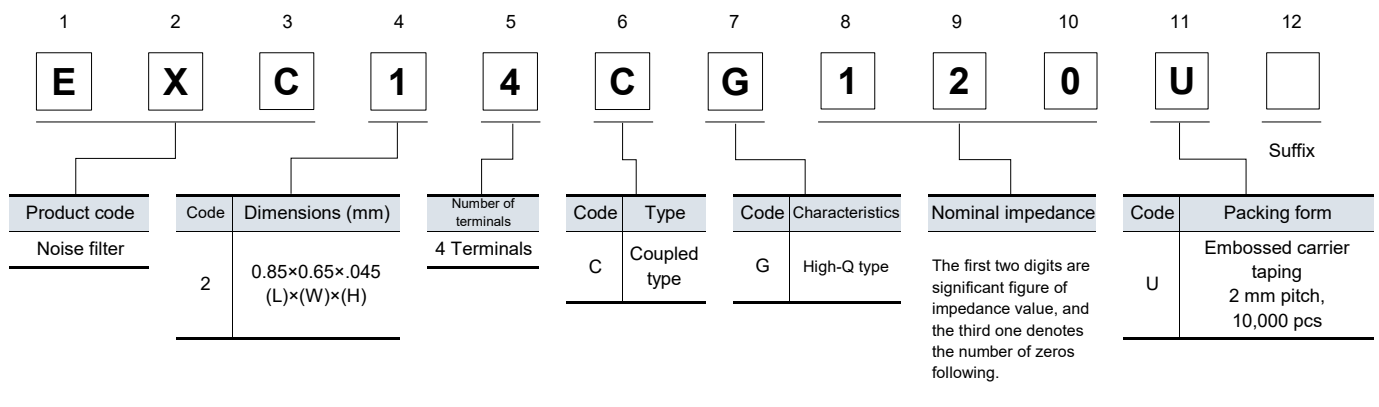

#### Construction

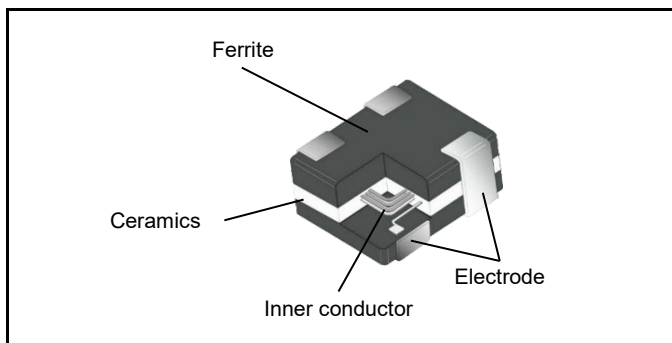

#### Circuit configuration (No polarity)

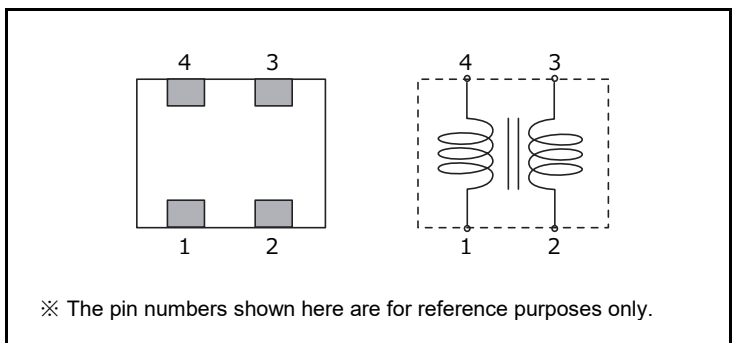

#### Dimensions in mm (not to scale)

Part No. (inch size)	Dimensions						Mass (Weight) (mg/ pc.)
	A	B	C	D	E	F	
EXC14CG(0302)	0.65 ± 0.05	0.85 ± 0.05	0.45 ± 0.05	0.10 min.	0.50 ± 0.10	0.27 ± 0.10	1.4

Unit : mm

**Ratings**

Part number	Impedance ( $\Omega$ ) at 100 MHz		Rated voltage (V) DC	Rated current (mA) DC	DC resistance ( $\Omega$ ) max.
	Common mode	Differential mode			
EXC14CG120U	12 $\pm$ 30 %	10 max.	5	130	2.0
EXC14CG350U	35 $\pm$ 30 %	15 max.	5	100	2.0
EXC14CG430U	43 $\pm$ 25 %	15 max.	5	100	2.7

● Category temperature range  $-40\text{ }^{\circ}\text{C}$  to  $+85\text{ }^{\circ}\text{C}$

**Characteristics graph (Reference data)**

● EXC14CG120U

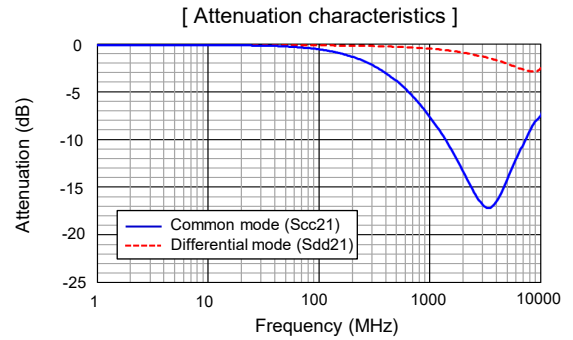
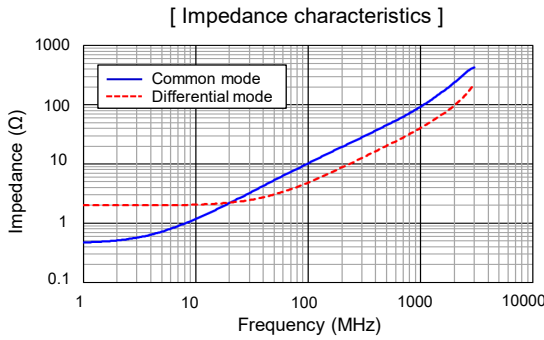

● EXC14CG350U

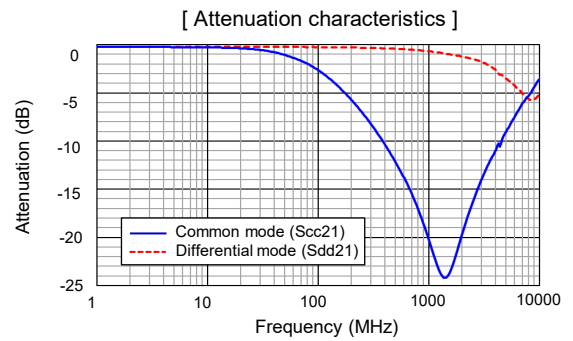
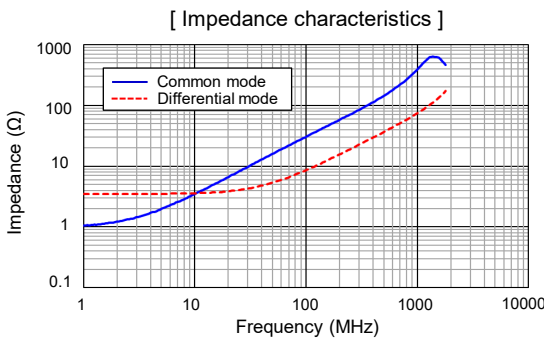

● EXC14CG430U

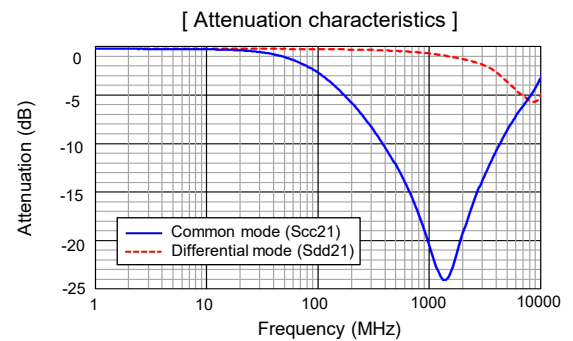
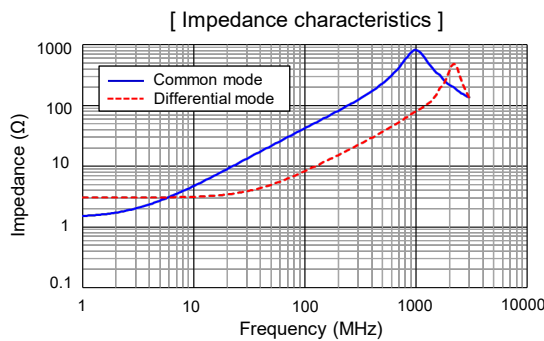

● Impedance measurement circuit

(A) Common mode

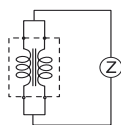

(B) Differential mode

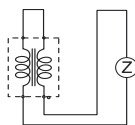

■ As for packaging methods, soldering conditions and safety precautions, please see data files

# Common Mode Noise Filters

## EXC14CT type

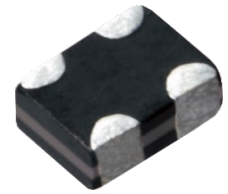

### Features

- Small and thin (L 0.85 mm×W 0.65 mm×H 0.45 mm)
- High attenuation at common-mode for noise suppression of harmonic signal components and cellular frequency
- High cut-off frequency and capability of coping with high-speed signals (HDMI)
- Strong multilayer/sintered structure, excellent reflow resistance and high mounting reliability
- RoHS compliant

### Recommended applications

- Smartphones, Tablet PCs and DSC
- Noise suppression of high-speed differential data lines such as MIPI, LVDS

### Explanation of part numbers

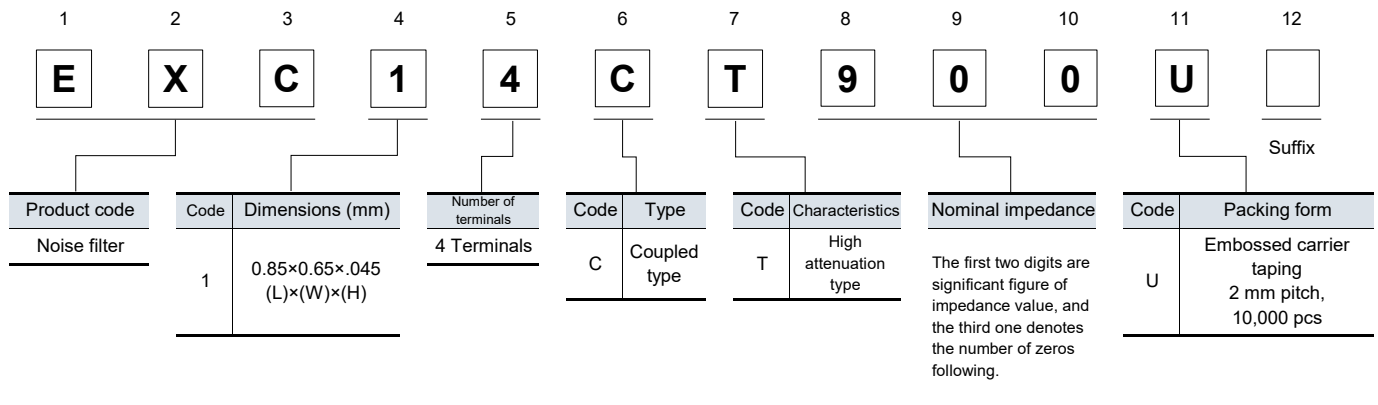

### Construction

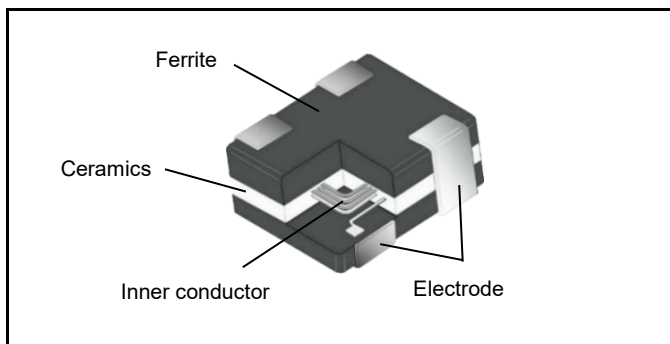

### Circuit configuration (No polarity)

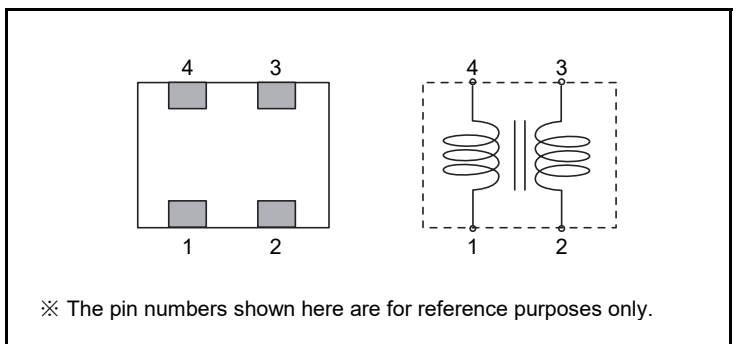

### Dimensions in mm (not to scale)

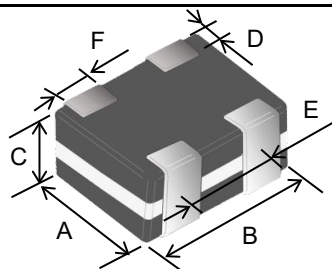

Unit : mm

Part No. (inch size)	Dimensions						Mass (Weight) (mg/ pc.)
	A	B	C	D	E	F	
EXC14CT (0302)	0.65 ± 0.05	0.85 ± 0.05	0.45 ± 0.05	0.10 min.	0.50 ± 0.10	0.27 ± 0.10	1.0

**Ratings**

Part number	Impedance ( $\Omega$ ) at 100 MHz		Rated voltage (V) DC	Rated current (mA) DC	DC resistance ( $\Omega$ )
	Common mode	Differential mode			
EXC14CT500U	50 $\Omega \pm 25 \%$	17 $\Omega$ max.	5	100	2.3 $\Omega \pm 30 \%$
EXC14CT900U	90 $\Omega \pm 20 \%$	20 $\Omega$ max.	5	100	3.3 $\Omega \pm 30 \%$

● Category temperature range  $-40\text{ }^{\circ}\text{C}$  to  $+85\text{ }^{\circ}\text{C}$

**Characteristics graph (Reference data)**

● EXC14CT500U

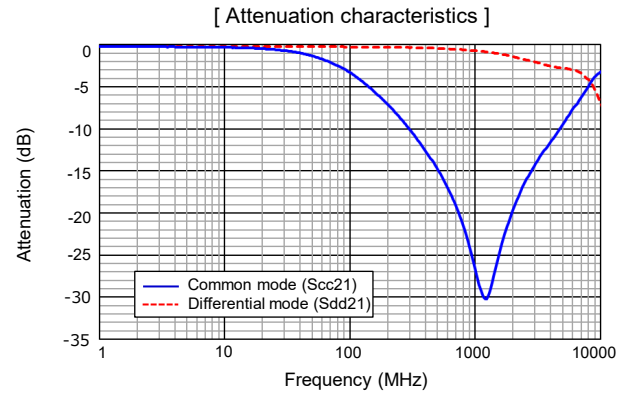
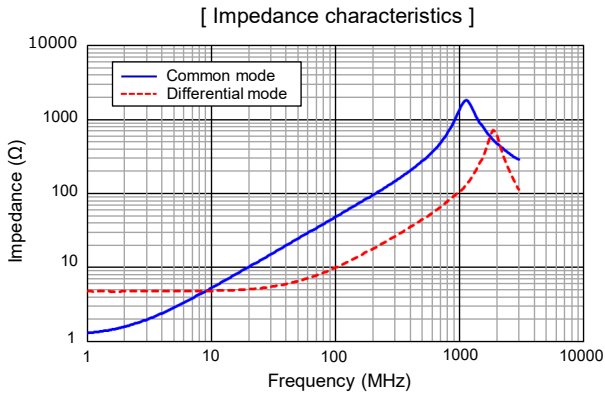

● EXC14CT900U

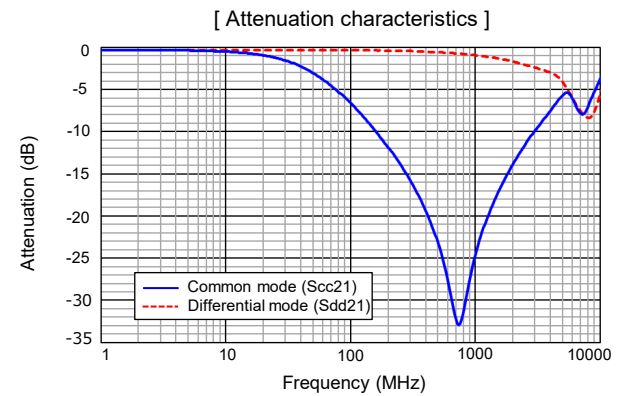
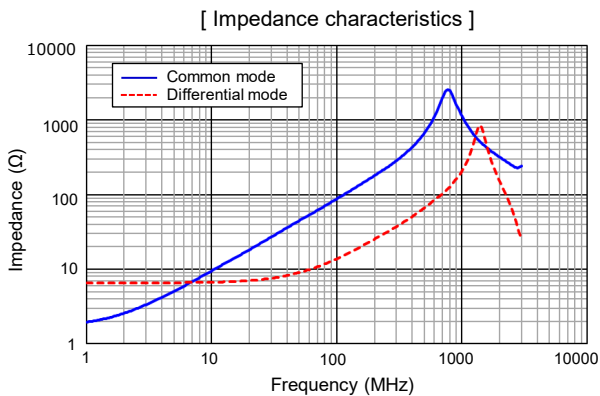

● Impedance measurement circuit

(A) Common mode

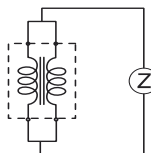

(B) Differential mode

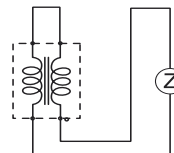

■ As for packaging methods, soldering conditions and safety precautions, please see data files

# Common Mode Noise Filters

## EXC14CX type



### Features

- Small and thin (L 0.85 mm×W 0.65 mm×H 0.45 mm)
- Effective noise suppression of smartphones by eliminating common mode noises and removing differential signal components
- Strong multilayer/sintered structure, excellent reflow resistance and high mounting reliability
- RoHS compliant

### Recommended applications

- Smartphones, Tablet PCs and DSC
- Noise suppression of high-speed differential data lines such as MIPI, USB and LVDS

### Explanation of part numbers

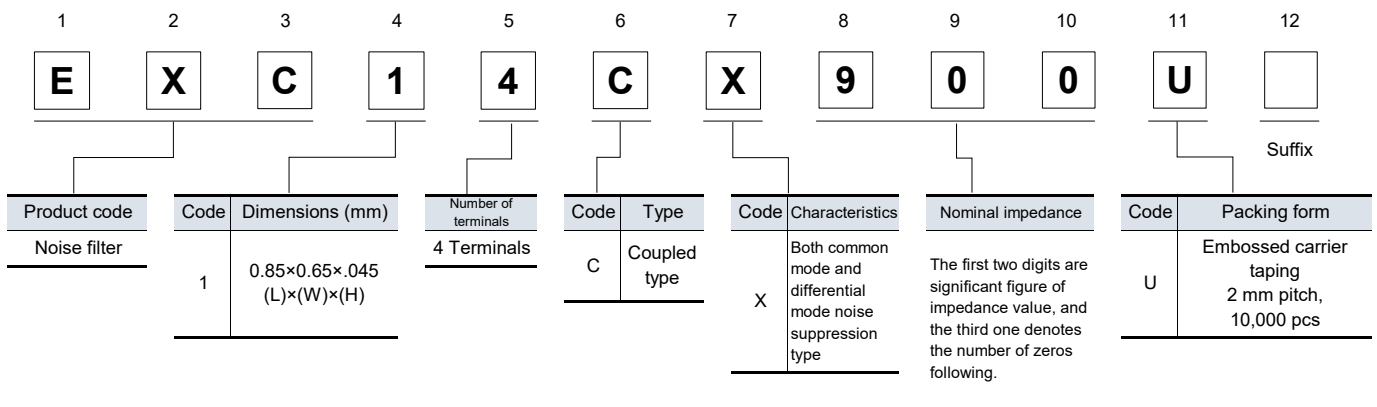

### Construction

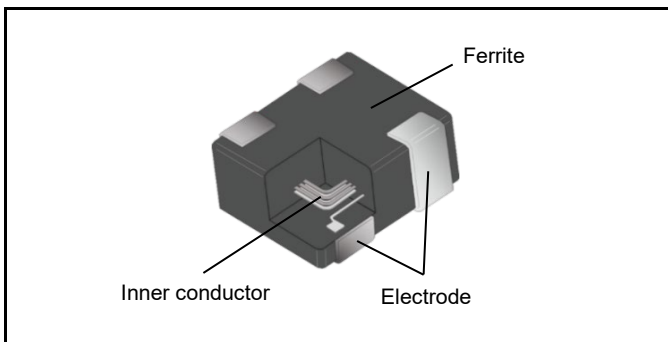

### Circuit configuration (No polarity)

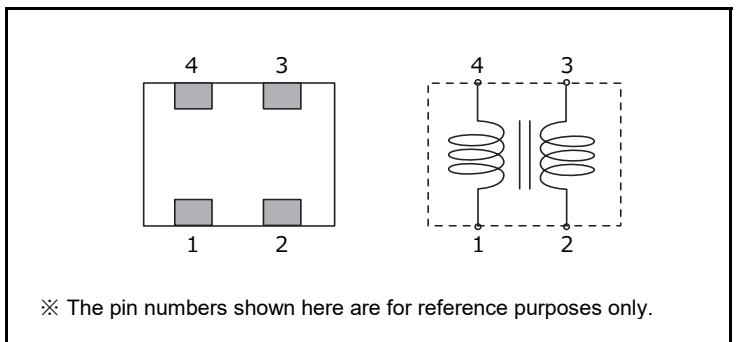

### Dimensions in mm (not to scale)

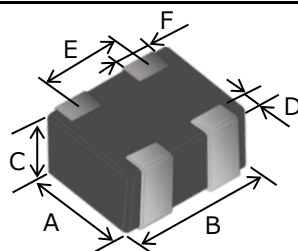

Unit : mm

Part No. (inch size)	Dimensions						Mass (Weight) (mg/ pc.)
	A	B	C	D	E	F	
EXC14CX (0302)	0.65 ± 0.05	0.85 ± 0.05	0.45 ± 0.05	0.10 min.	0.50 ± 0.10	0.27 ± 0.10	1.4

**Ratings**

Part number	Impedance ( $\Omega$ ) at 100 MHz		Rated voltage (V) DC	Rated current (mA) DC	DC resistance ( $\Omega$ ) max.
	Common mode	Differential mode			
EXC14CX280U	28 $\Omega \pm 25\%$	25 $\Omega$ max.	5	100	3.0
EXC14CX400U	40 $\Omega \pm 25\%$	30 $\Omega$ max.	5	100	4.0

● Category temperature range  $-40\text{ }^{\circ}\text{C}$  to  $+85\text{ }^{\circ}\text{C}$

**Characteristics graph (Reference data)**

● EXC14CX280U

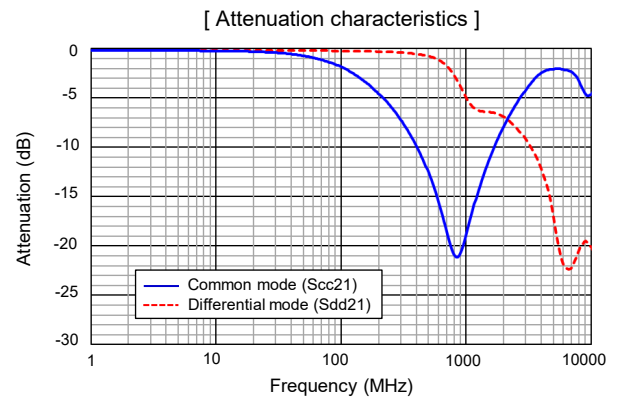
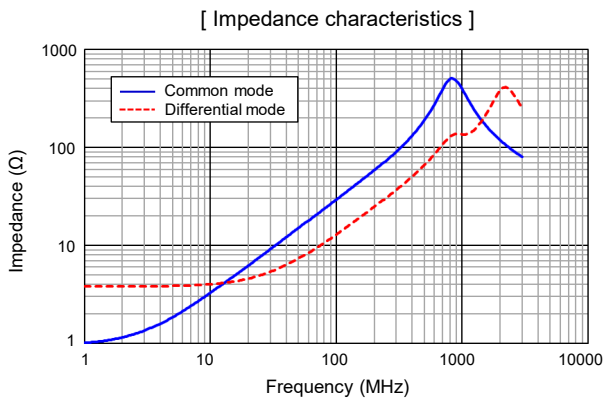

● EXC14CX400U

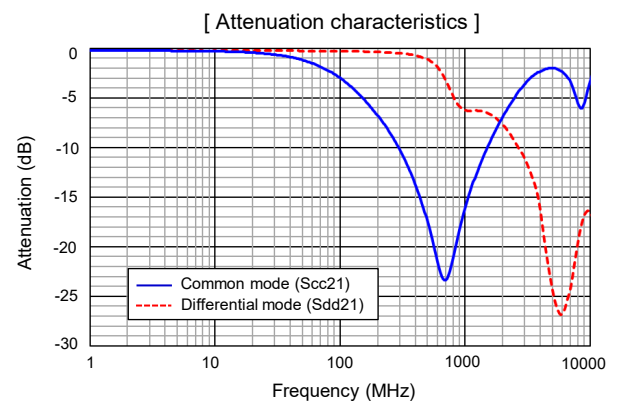
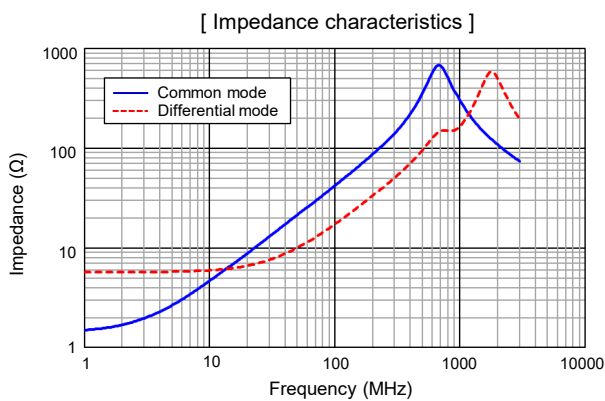

● Impedance measurement circuit

(A) Common mode

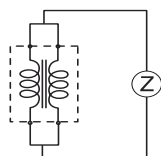

(B) Differential mode

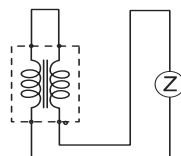

■ As for packaging methods, soldering conditions and safety precautions, please see data files



## Common Mode Noise Filters

### EXC16CT type

#### Features

- Corresponding to new high-speed differential interface (MIPI C-PHY)  
Corresponding to 3-line transmission, transmission rate up to 2.5 Gbps
- Unique plating fine coil process and ceramic multilayer process enable compact size  
(L 0.90 × W 0.68 × H 0.40 mm)  
around 40% reduction of mounting area (comparing with MIPI D-PHY)
- Strong multilayer/sintered structure, excellent reflow resistance and high mounting reliability
- Lead, halogen and antimony-free
- RoHS compliant

#### Recommended applications

- High resolution camera and display equipped mobile devices (Smartphones, Tablet PCs and wearable)
- Noise suppression of high-speed differential data lines such as MIPI C-PHY

#### Explanation of part numbers

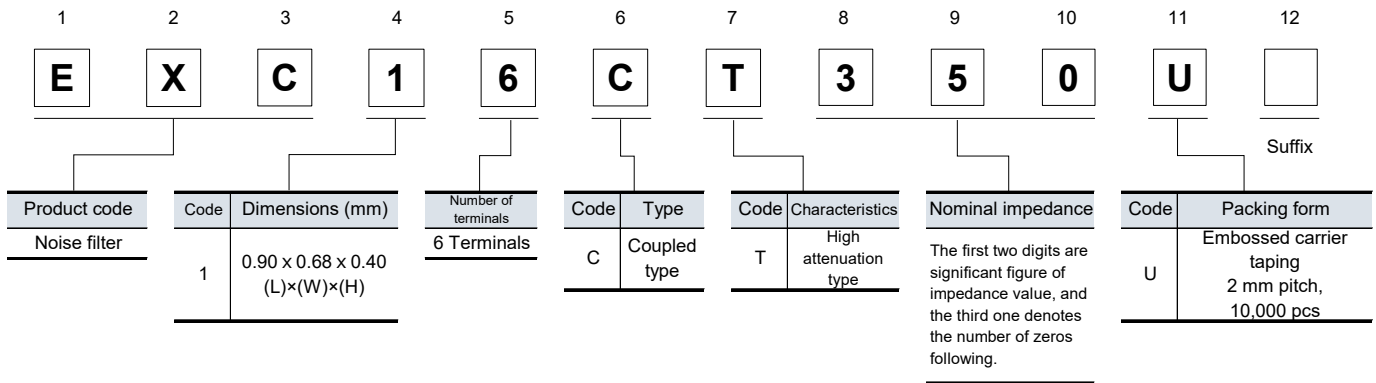

#### Construction

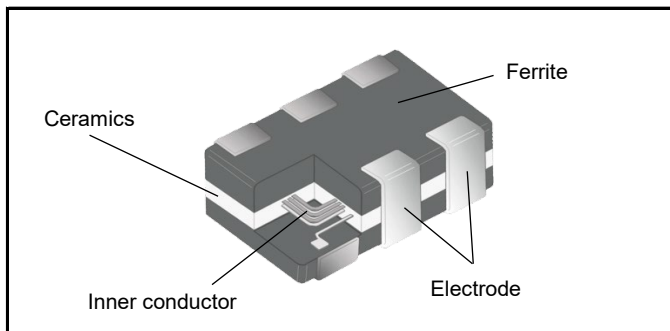

#### Circuit configuration (No polarity)

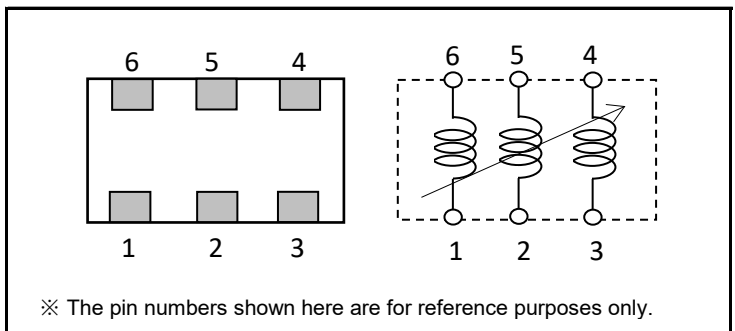

#### Dimensions in mm (not to scale)

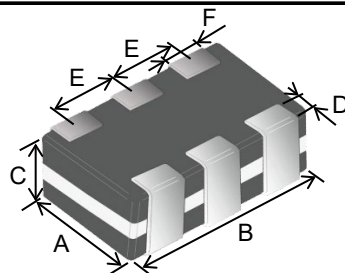

Unit : mm

Part No. (inch size)	Dimensions						Mass (Weight) (mg/ pc.)
	A	B	C	D	E	F	
EXC16CT (0403)	0.68 ± 0.05	0.90 ± 0.05	0.40 ± 0.05	0.125 ± 0.075	0.35 ± 0.05	0.165 ± 0.065	1.1

**Ratings**

Part number	Impedance ( $\Omega$ ) at 100 MHz		Rated voltage (V) DC	Rated current (mA) DC	DC resistance ( $\Omega$ ) max.
	Common mode				
EXC16CT250U	25 $\Omega$ $\pm$ 25 %		5	100	3.0
EXC16CT350U	35 $\Omega$ $\pm$ 30 %		5	100	4.0

● Category temperature range  $-40\text{ }^{\circ}\text{C}$  to  $+85\text{ }^{\circ}\text{C}$

**Characteristics graph (Reference data)**

● EXC16CT250U

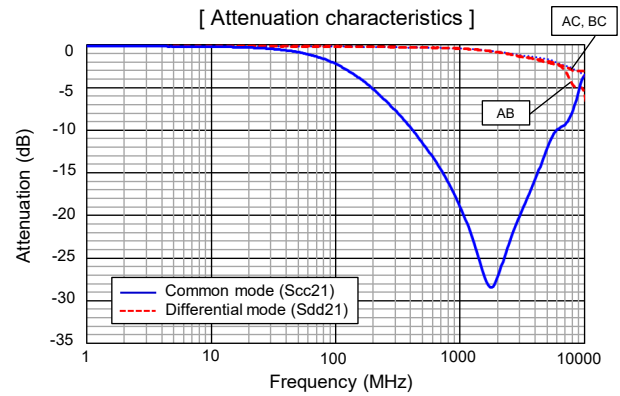
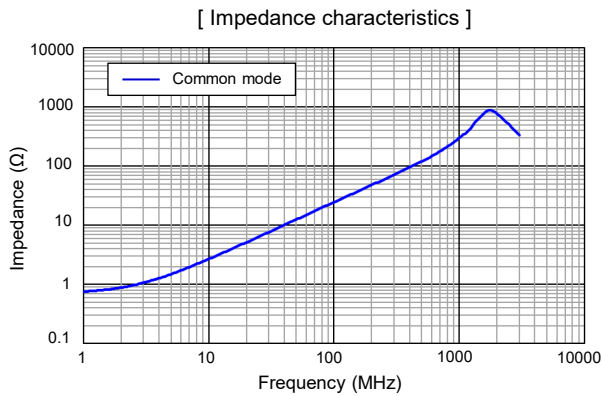

● EXC16CT350U

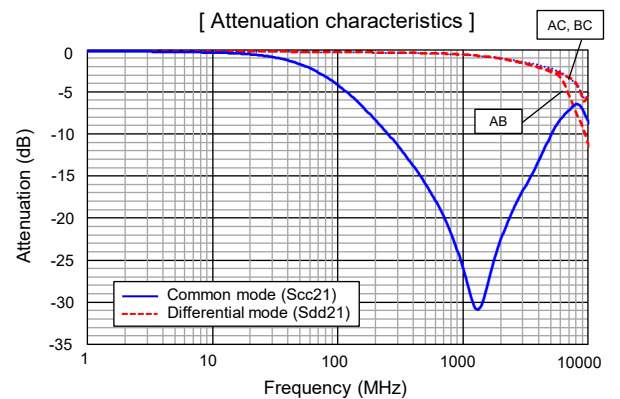
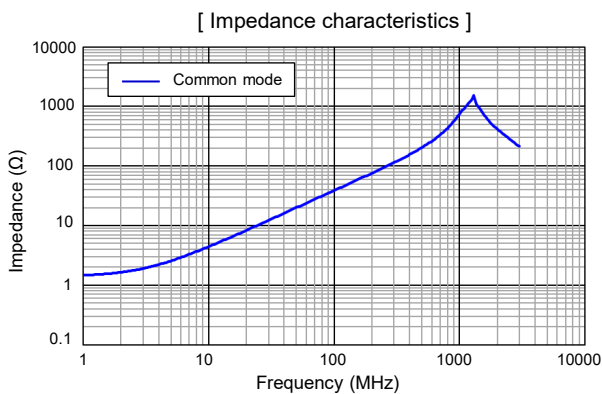

● Impedance measurement circuit

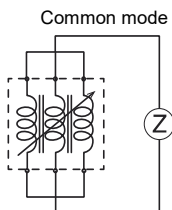

● Attenuation measurement circuit

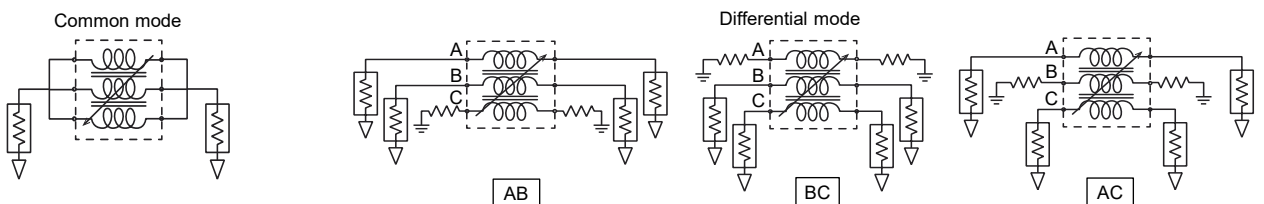

■ As for packaging methods, soldering conditions and safety precautions, please see data files

## Common Mode Noise Filters

### EXC24CK type

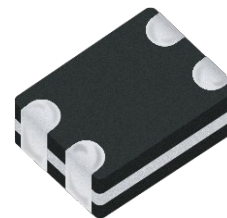

#### Features

- Small and thin type (L 1.25 mm×W 1.00 mm×H 0.50 mm)
- Since the cut-off frequency (of the CMNF) is so high, high frequency noise are suppressed without signal integrity degradation.
- Strong multilayer/sintered structure, excellent reflow resistance and high mounting reliability
- RoHS compliant

#### Recommended applications

- AV equipment (LCD-TV, DVD/Blu-ray drives), Information equipment (PCs, HDD), Communications equipment (Mobile phones, Smartphones)
- Noise suppression for high-speed differential data lines of information devices such as PCs equipped with USB3.2, HDMI, SATA, Display Port, etc.

#### Explanation of part numbers

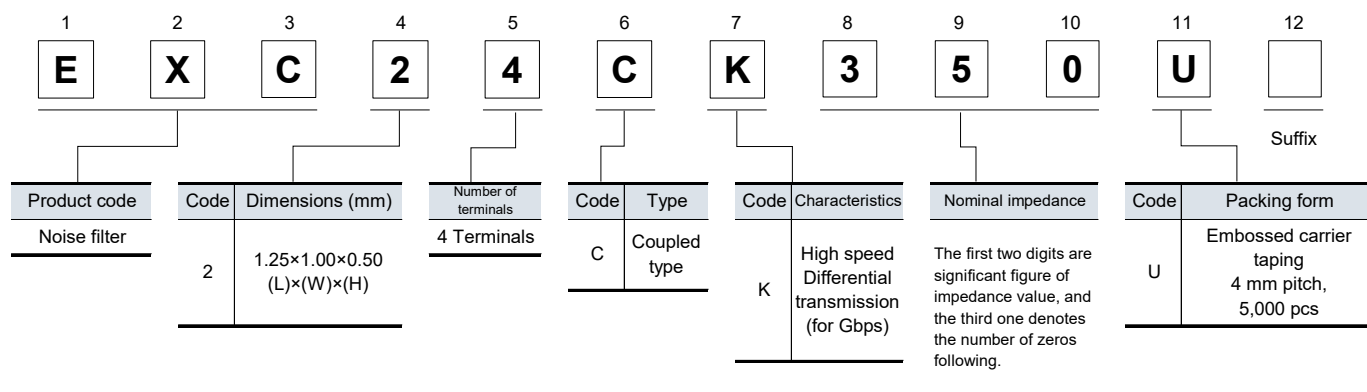

#### Construction

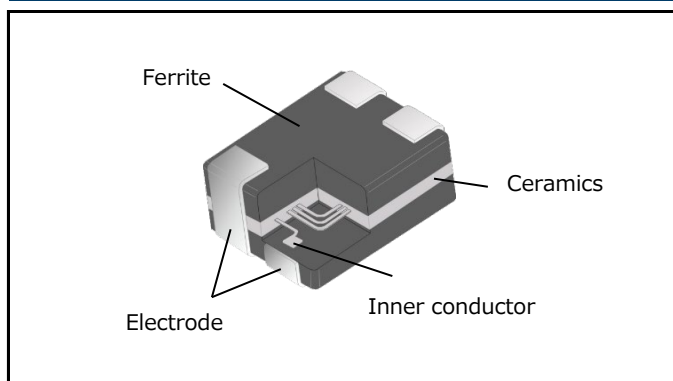

#### Circuit configuration (No polarity)

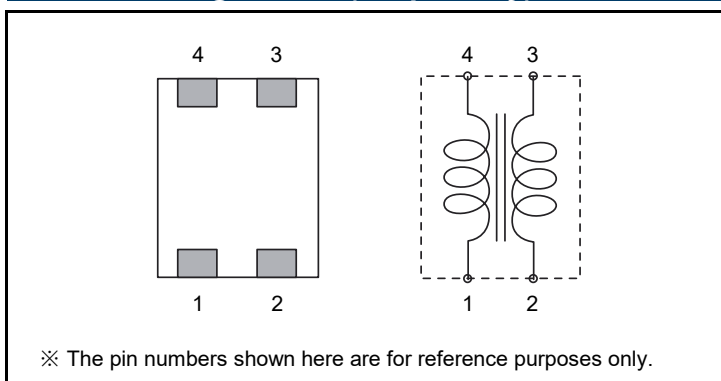

#### Dimensions in mm (not to scale)

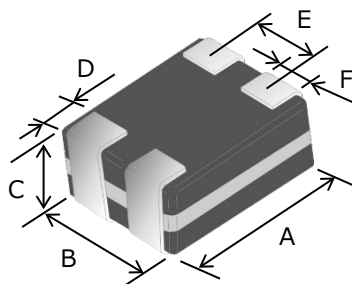

Part No. (inch size)	Dimensions						Mass (Weight) (mg/ pc.)
	A	B	C	D	E	F	
EXC24CK (0504)	1.25 ± 0.15	1.00 ± 0.15	0.50 ± 0.10	0.20 ± 0.15	0.55 ± 0.10	0.30 ± 0.10	2.1

Unit : mm

**Ratings**

Part number	Impedance ( $\Omega$ ) at 100 MHz		Cutoff frequency (GHz)	Rated voltage (V) DC	Rated current (mA) DC	DC resistance ( $\Omega$ ) max.
	Common mode	Differential mode				
EXC24CK350U	35 $\Omega$ $\pm$ 30 %	13 $\Omega$ max.	10 Typ.	5	160	1.5

● Category temperature range  $-40\text{ }^{\circ}\text{C}$  to  $+85\text{ }^{\circ}\text{C}$

**Characteristics graph (Reference data)**

● EXC24CK350U

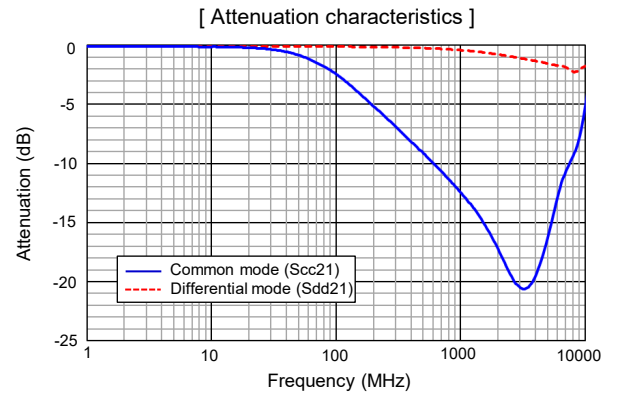
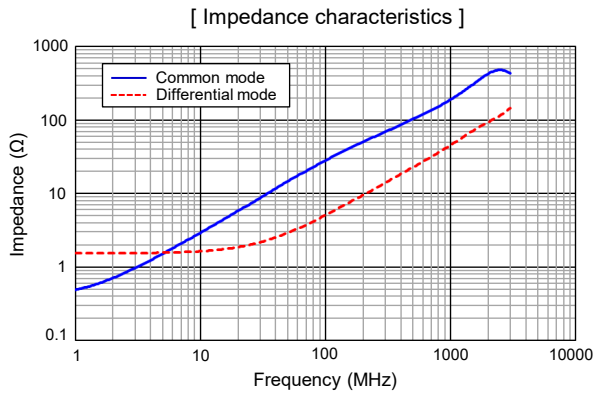

● Impedance measurement circuit

(A) Common mode

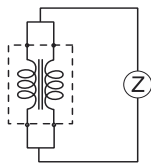

(B) Differential mode

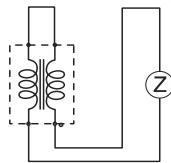

■ As for packaging methods, soldering conditions and safety precautions, please see data files

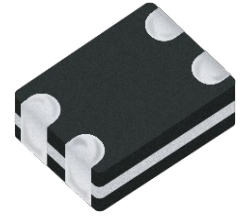

## Common Mode Noise Filters

### EXC24CH type

#### Features

- Small and thin type (L 1.25 mm×W 1.00 mm×H 0.50 mm)
- Since the cut-off frequency (of the CMNF) is so high, high frequency noise are suppressed without signal integrity degradation.
- Strong multilayer/sintered structure, excellent reflow resistance and high mounting reliability
- RoHS compliant

#### Recommended applications

- AV equipment (LCD-TV, DVD/Blu-ray drives), Information equipment (PCs, HDD), Communications equipment (Mobile phones, Smartphones)
- Noise suppression of high-speed differential data lines such as USB 3.2, HDMI and Display Port

#### Explanation of part numbers

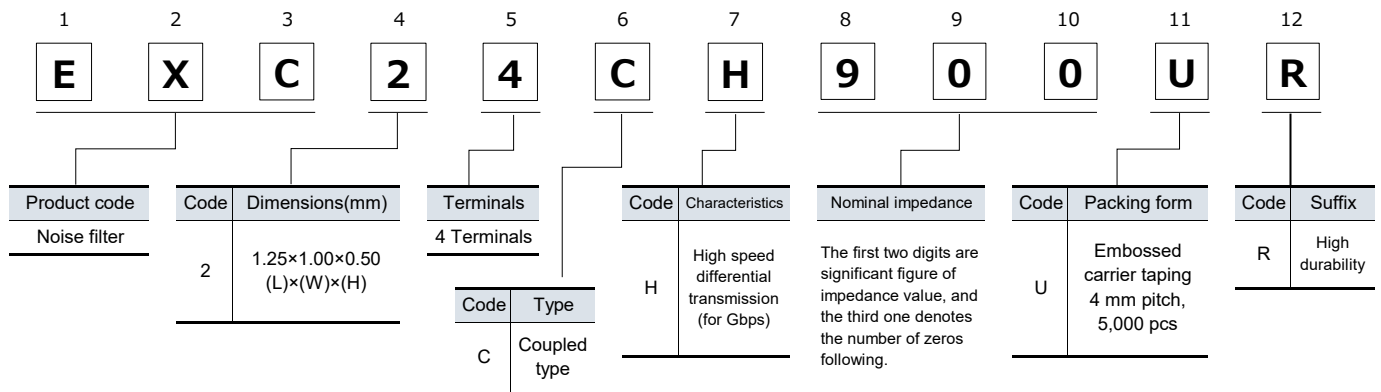

#### Construction

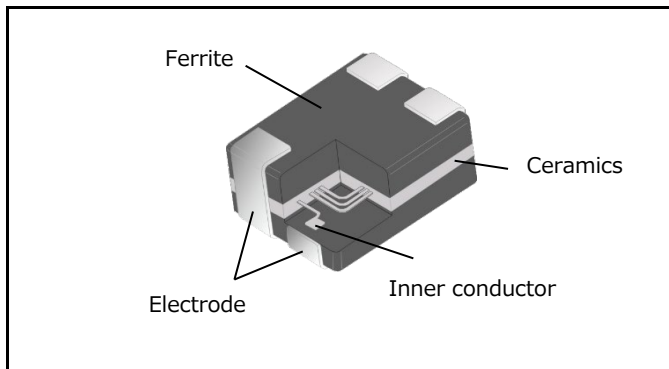

#### Circuit configuration (No polarity)

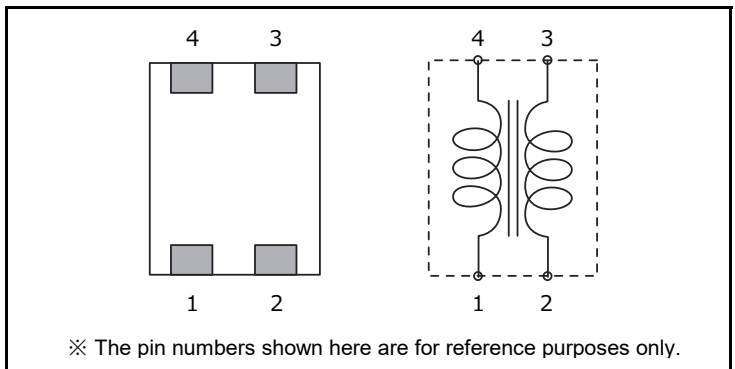

#### Dimensions in mm (not to scale)

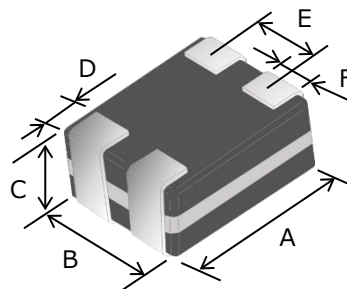

Unit : mm

Part No. (inch size)	Dimensions						Mass (Weight) (mg/ pc.)
	A	B	C	D	E	F	
EXC24CH (0504)	1.25 ± 0.15	1.00 ± 0.15	0.50 ± 0.10	0.20 ± 0.15	0.55 ± 0.10	0.30 ± 0.10	2.4

**Ratings**

Part number	Impedance ( $\Omega$ ) at 100 MHz		Cutoff frequency (GHz)	Rated voltage (V) DC	Rated current (mA) DC	DC resistance ( $\Omega$ ) max.
	Common mode	Differential mode				
EXC24CH500UR	50 $\Omega$ $\pm$ 25 %	13 $\Omega$ max.	8 Typ.	5	160	1.5
<small>NRFND</small> EXC24CH500U						
EXC24CH900UR	90 $\Omega$ $\pm$ 20 %	15 $\Omega$ max.	5 Typ.	5	130	2.5
<small>NRFND</small> EXC24CH900U						

● Category temperature range  $-40\text{ }^{\circ}\text{C}$  to  $+85\text{ }^{\circ}\text{C}$

NRFND Not recommended for new design

**Characteristics graph (Reference data)**

● EXC24CH500UR / EXC24CH500U

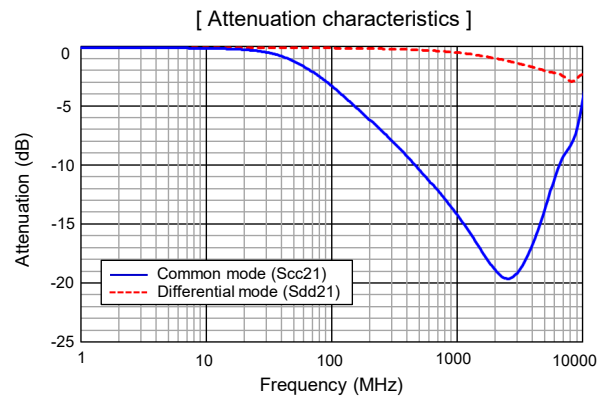
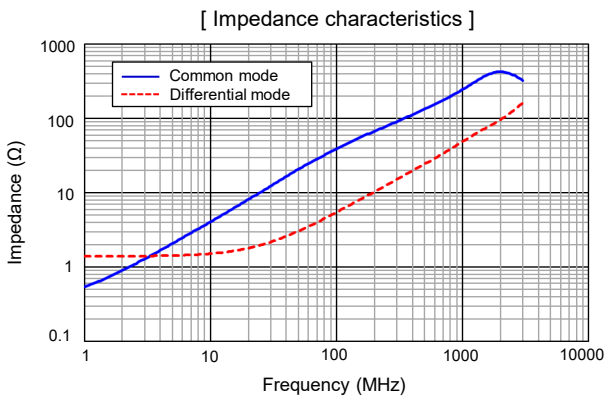

● EXC24CH900UR / EXC24CH900U

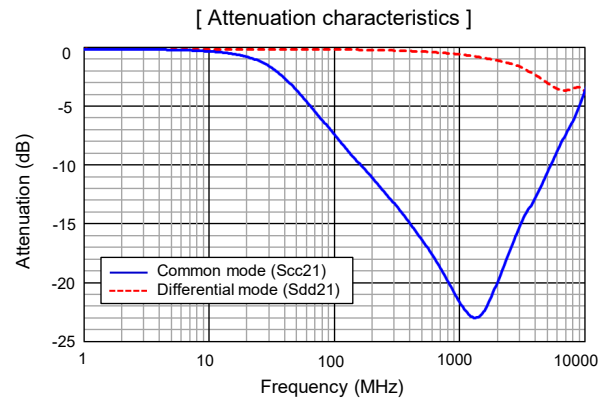
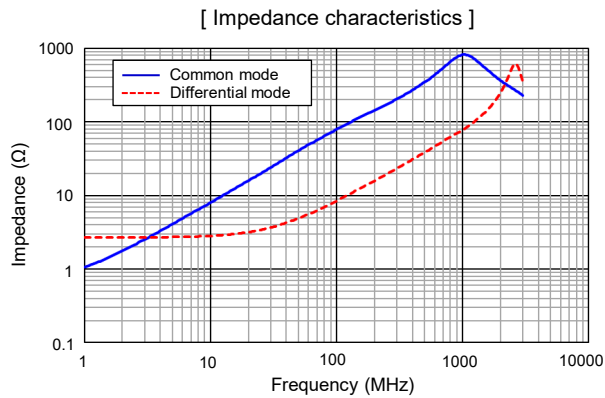

● Impedance measurement circuit

(A) Common mode

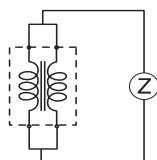

(B) Differential mode

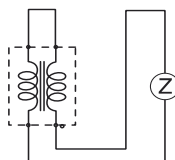

■ As for packaging methods, soldering conditions and safety precautions, please see data files

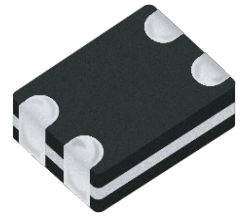

# Common Mode Noise Filters

## EXC24CG type

### Features

- Elimination of radiation noises from high-speed differential transmissions
- Prevention of reflection of transmission signals and noise radiation by controlling TDR characteristic impedance as 100 Ω
- Satisfaction of eye pattern standards of HDMI waveforms with capability to improve waveform fluctuations of skew and overshoot
- Simple multilayer structure, excellent mass productivity and high reliability
- Small and thin (L 1.25 mm×W 1.00 mm×H 0.50 mm)
- RoHS compliant

### Recommended applications

- AV equipment (LCD-TV, DVD/Blu-ray drives), Information equipment (PCs, HDD), Communications equipment (Mobile phones, Smartphones)
- Noise suppression of high-speed differential data lines such as HDMI, SATA and LAN

### Explanation of part numbers

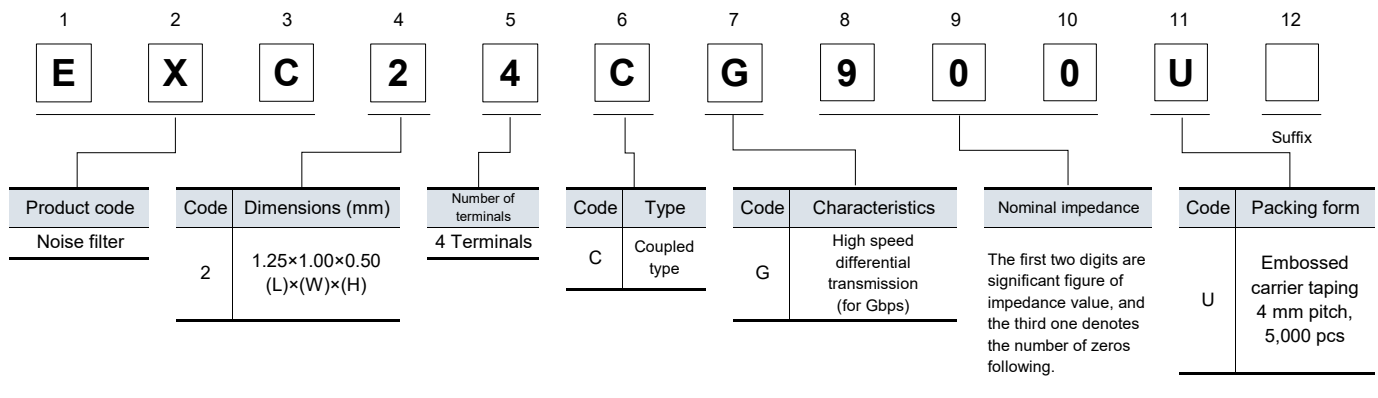

### Construction

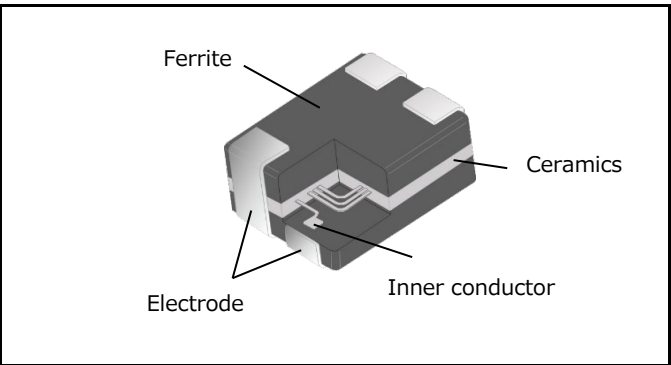

### Circuit configuration (No polarity)

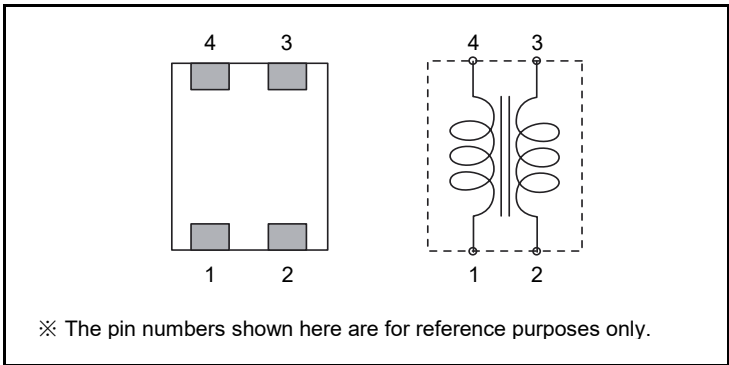

### Dimensions in mm (not to scale)

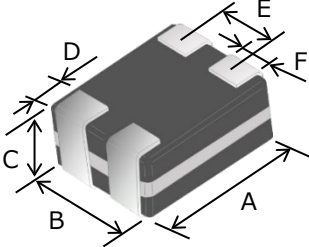

Part No. (inch size)	Dimensions						Mass (Weight) (mg/ pc.)
	A	B	C	D	E	F	
EXC24CG (0504)	1.25 ± 0.15	1.00 ± 0.15	0.50 ± 0.10	0.20 ± 0.15	0.55 ± 0.10	0.30 ± 0.10	3.0

Unit : mm

**Ratings**

Part number	Impedance ( $\Omega$ ) at 100 MHz		Rated voltage (V) DC	Rated current (mA) DC	DC resistance ( $\Omega$ ) max.
	Common mode	Differential mode			
EXC24CG240U	24 $\pm$ 25 %	15 max.	5	160	1.5
EXC24CG360U	36 $\pm$ 25 %	15 max.	5	130	1.7
EXC24CG900U	90 $\pm$ 25 %	20 max.	5	100	3.0

● Category temperature range  $-40\text{ }^{\circ}\text{C}$  to  $+85\text{ }^{\circ}\text{C}$

**Characteristics graph (Reference data)**

● EXC24CG240U

[ Impedance characteristics ]

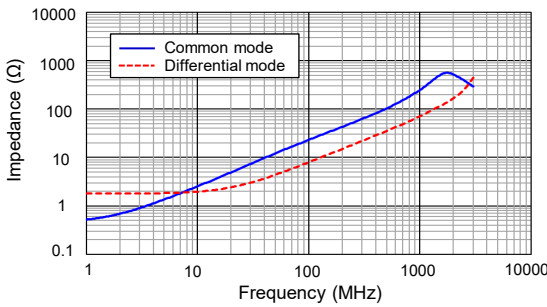

[ Attenuation characteristics ]

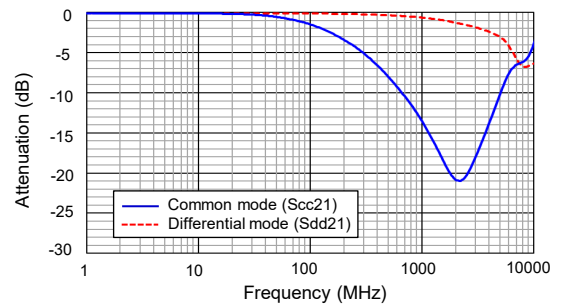

● EXC24CG360U

[ Impedance characteristics ]

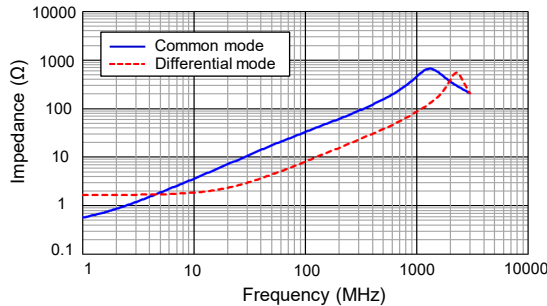

[ Attenuation characteristics ]

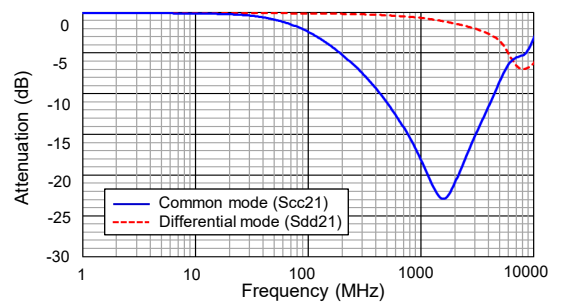

● EXC24CG900U

[ Impedance characteristics ]

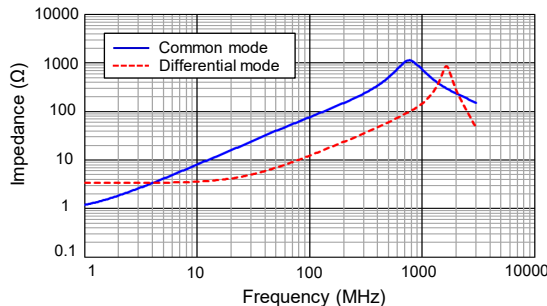

[ Attenuation characteristics ]

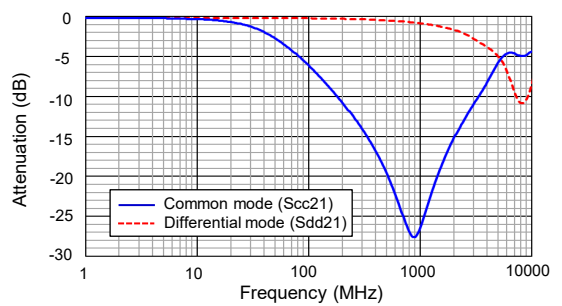

● Impedance measurement circuit

(A) Common mode

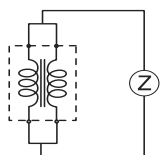

(B) Differential mode

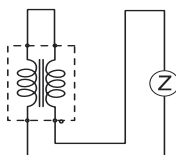

■ As for packaging methods, soldering conditions and safety precautions, please see data files

# Common Mode Noise Filters

## EXC24CE/CF type



### Features

- Elimination of radiation noises from high-speed differential transmissions
- Strong multilayer structure, excellent reflow resistance and high mounting reliability
- Magnetic shield type with no leakage
- High-Q impedance : EXC24CF
- Small and thin (L 1.25 mm×W 1.00 mm×H 0.50 mm)
- RoHS compliant

### Recommended applications

- AV equipment (LCD-TV, DVD/Blu-ray drives), Information equipment (PCs, HDD, Printers), Communications equipment (Mobile phones, Smartphones)
- Noise suppression of high-speed differential data lines such as USB 2.0 and LVDS

### Explanation of part numbers

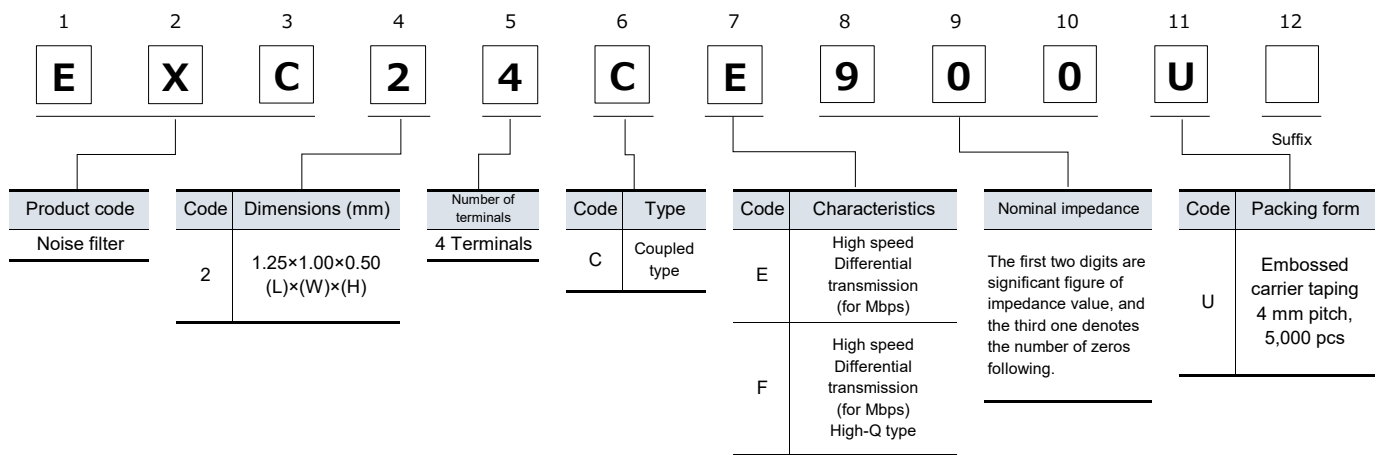

### Construction

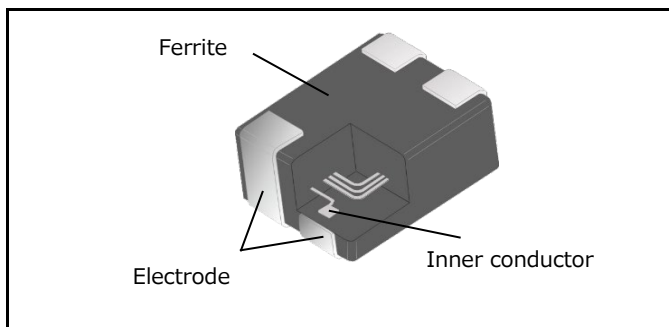

### Circuit configuration (No polarity)

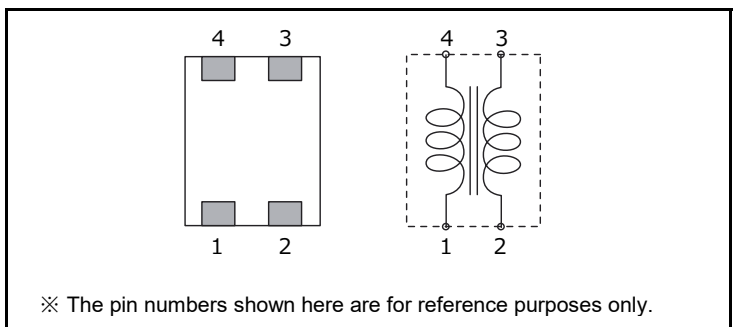

### Dimensions in mm (not to scale)

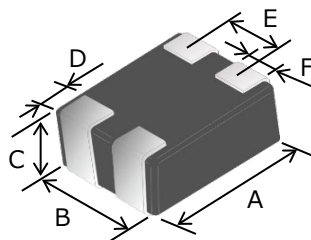

Part No. (inch size)	Dimensions						Mass (Weight) (mg/ pc.)
	A	B	C	D	E	F	
EXC24CE (0504)	1.25 ± 0.15	1.00 ± 0.15	0.50 ± 0.10	0.20 ± 0.15	0.55 ± 0.10	0.30 ± 0.10	3.0
EXC24CF (0504)							

**Ratings**

Part number	Impedance ( $\Omega$ ) at 100 MHz		Rated voltage (V) DC	Rated current (mA) DC	DC resistance ( $\Omega$ ) max.
	Common mode	Differential mode			
EXC24CE360UP	36 $\Omega \pm 25 \%$	20 $\Omega$ max.	5	200	1.0
EXC24CE900U	90 $\Omega \pm 25 \%$	15 $\Omega$ max.	5	160	1.75
EXC24CE121U	120 $\Omega \pm 25 \%$	18 $\Omega$ max.	5	140	2.2
EXC24CE201U	200 $\Omega \pm 25 \%$	20 $\Omega$ max.	5	130	2.7
EXC24CE331U	330 $\Omega \pm 25 \%$	35 $\Omega$ max.	5	100	6.2
EXC24CF900U	90 $\Omega \pm 25 \%$	20 $\Omega$ max.	5	130	2.5

● Category temperature range  $-40\text{ }^{\circ}\text{C}$  to  $+85\text{ }^{\circ}\text{C}$

**Characteristics graph (Reference data)-1**

● EXC24CE360UP

[ Impedance characteristics ]

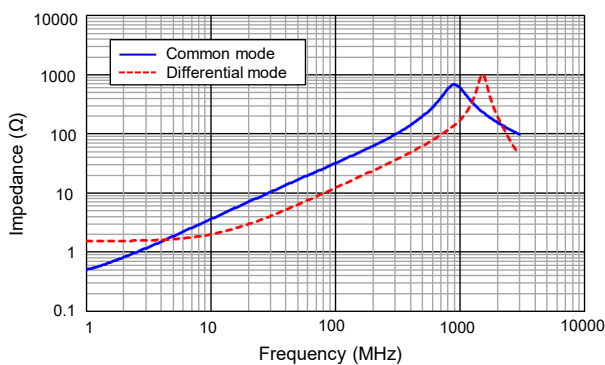

[ Attenuation characteristics ]

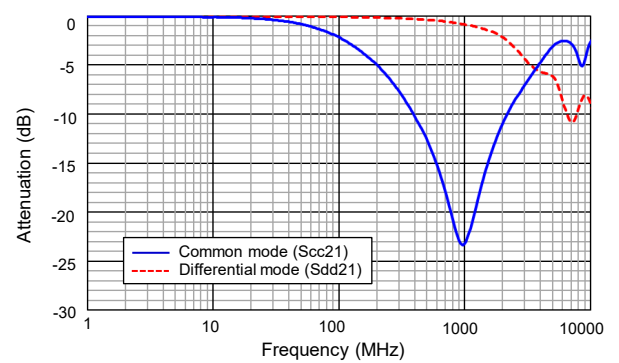

● EXC24CE900U

[ Impedance characteristics ]

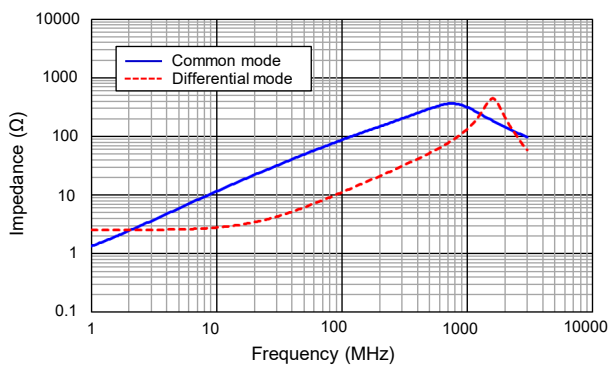

[ Attenuation characteristics ]

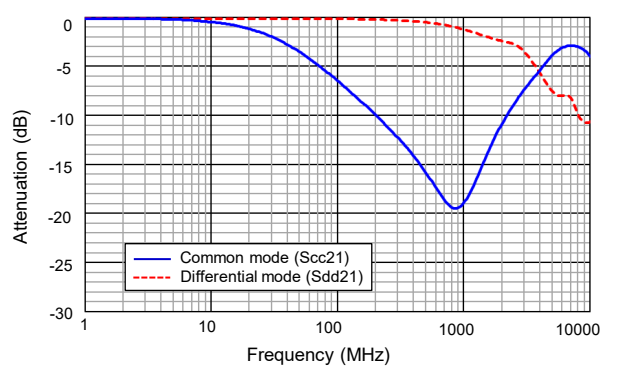

● EXC24CE121U

[ Impedance characteristics ]

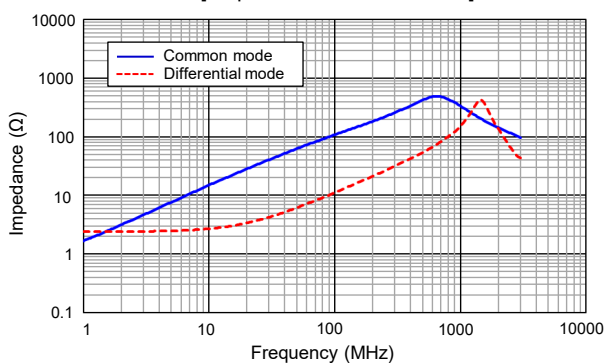

[ Attenuation characteristics ]

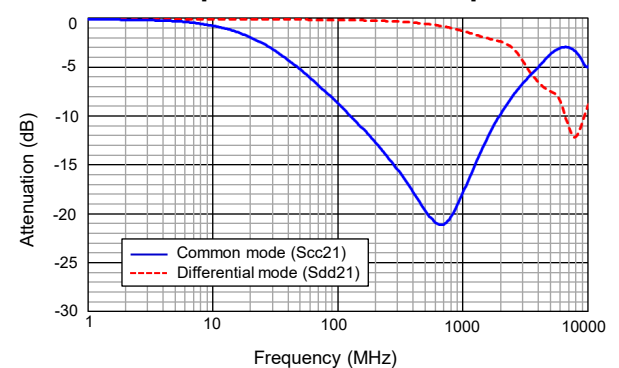

**Characteristics graph (Reference data)-2**

● EXC24CE201U

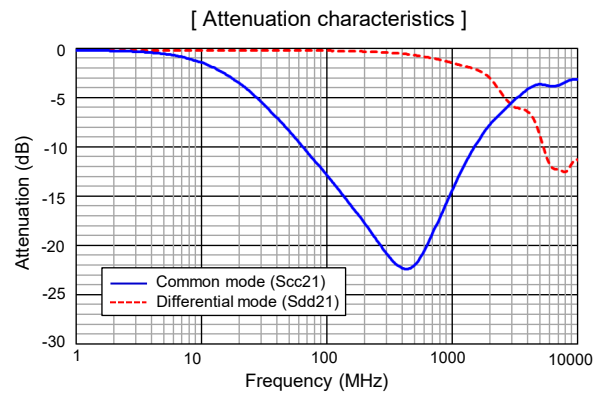
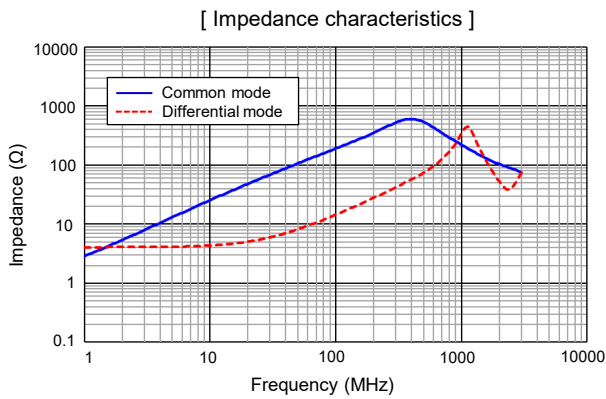

● EXC24CE331U

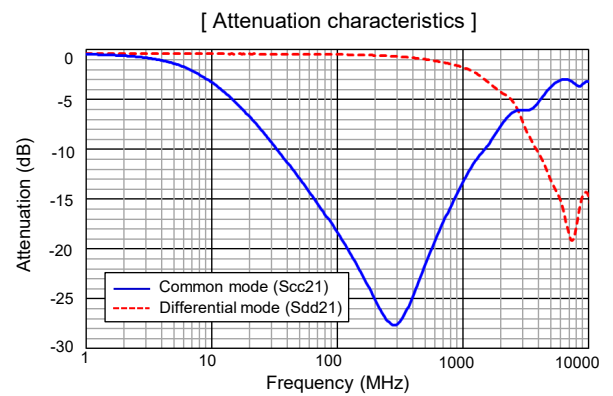
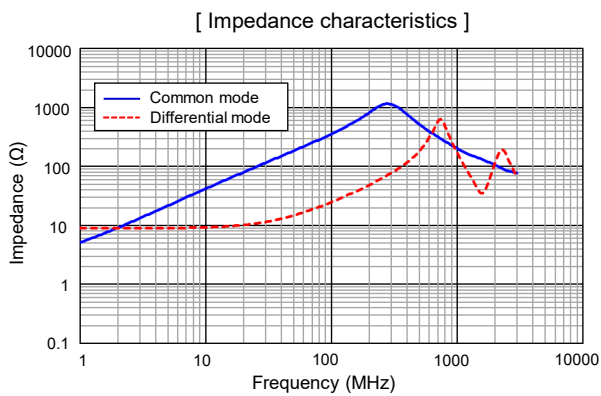

● EXC24CF900U

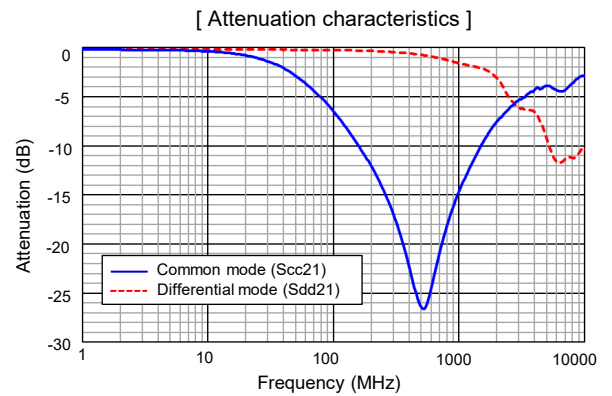
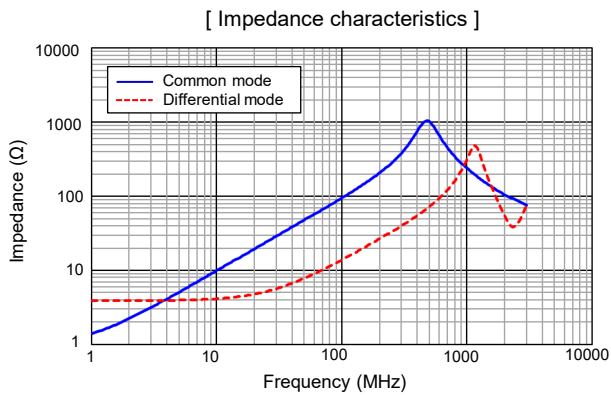

● Impedance measurement circuit

(A) Common mode

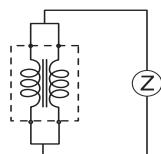

(B) Differential mode

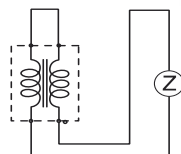

■ As for packaging methods, soldering conditions and safety precautions, please see data files

# Common Mode Noise Filters

## EXC34CE type



### Features

- Thin type (L 2.0 mm×W 1.25 mm×H 0.50 mm)
- Noise suppression of high-speed differential transmission lines with little influence of waveform rounding on signal transmission
- Strong multilayer/sintered structure, excellent reflow resistance and high mounting reliability
- Lead, halogen and antimony-free
- RoHS compliant

### Recommended applications

- AV equipment (LCD-TV, DVD/Blu-ray drives), Information equipment (PCs, HDD, Printers)
- Noise suppression of high-speed differential data lines such as USB2.0, LVDS, HDMI and LAN

### Explanation of part numbers

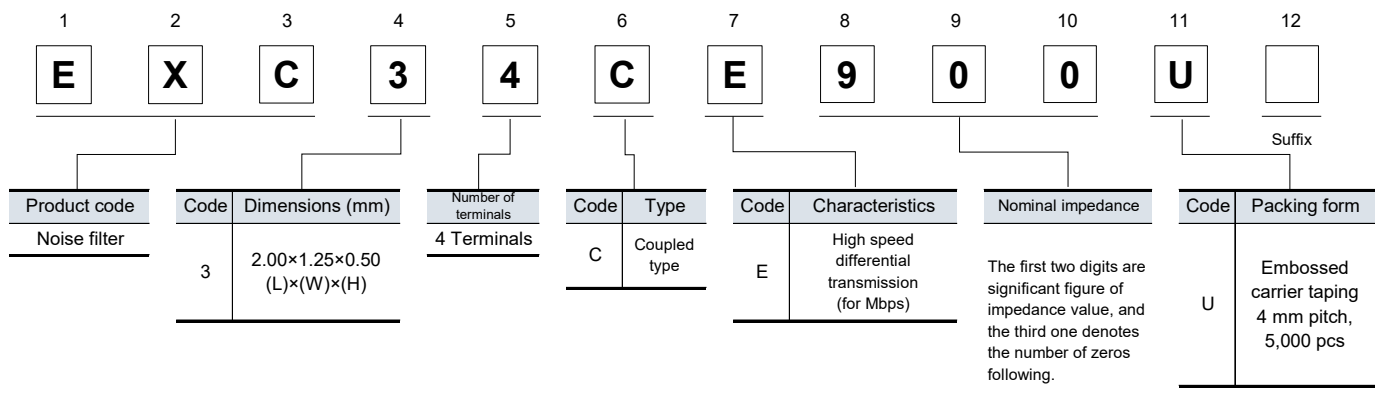

### Construction

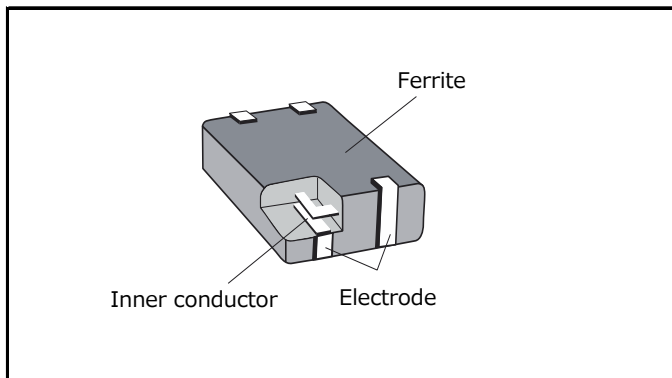

### Circuit configuration (No polarity)

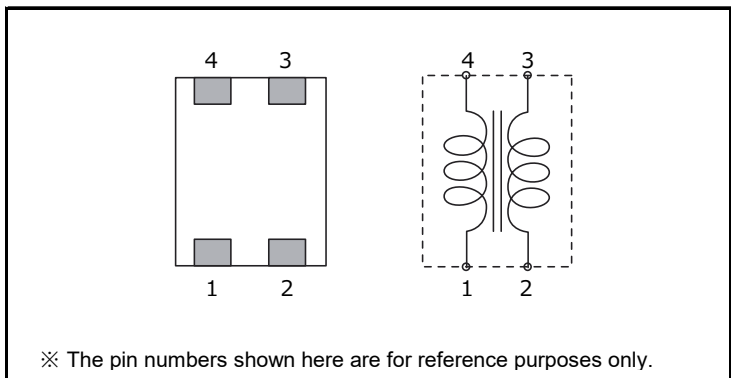

### Dimensions in mm (not to scale)

Part No. (inch size)	Dimensions						Mass (Weight) (mg/ pc.)
	A	B	C	D	E	F	
EXC34CE (0805)	2.00 ± 0.15	1.25 ± 0.15	0.50 ± 0.10	0.30 ± 0.20	0.80 ± 0.10	0.30 ± 0.15	5.0

Unit : mm

**Ratings**

Part number	Impedance ( $\Omega$ ) at 100 MHz		Rated current (mA) DC	Rated voltage (V) DC	Insulation resistance (M $\Omega$ ) min.	Withstand voltage (V) DC	DC resistance ( $\Omega$ ) max.
	Common mode						
EXC34CE670U	67 $\Omega \pm 25\%$		250	5	10 M $\Omega$	125	0.8
EXC34CE900U	90 $\Omega \pm 25\%$		250	5	10 M $\Omega$	125	0.8
EXC34CE121U	120 $\Omega \pm 25\%$		200	5	10 M $\Omega$	125	1.0
EXC34CE201U	200 $\Omega \pm 25\%$		200	5	10 M $\Omega$	125	1.0

● Category temperature range  $-40\text{ }^{\circ}\text{C}$  to  $+85\text{ }^{\circ}\text{C}$

**Characteristics graph (Reference data)-1**

● EXC34CE670U

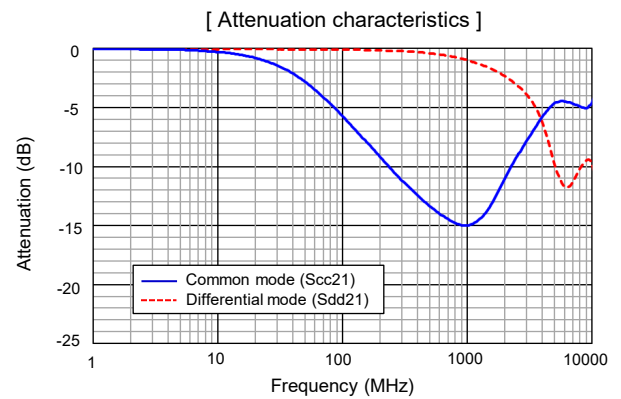
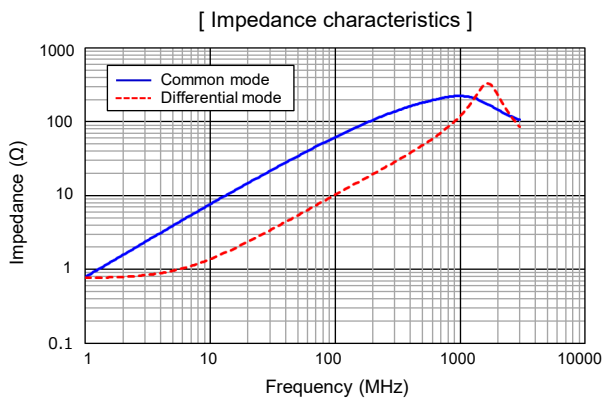

● EXC34CE900U

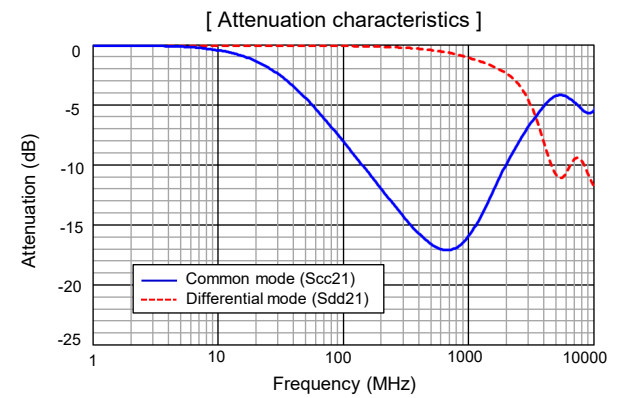
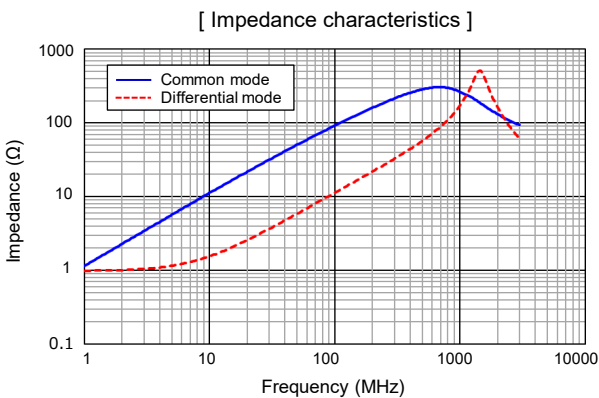

● EXC34CE121U

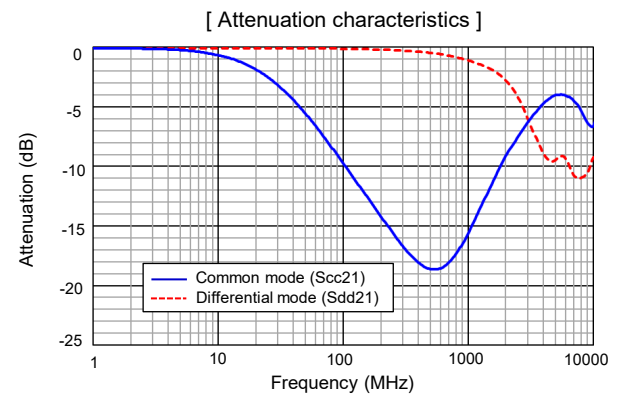
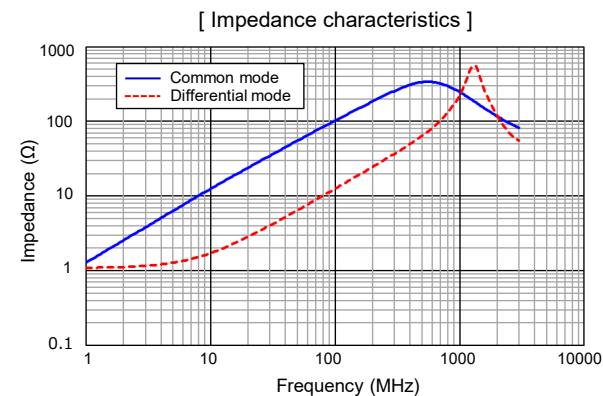

**Characteristics graph (Reference data)-2**

● EXC34CE201U

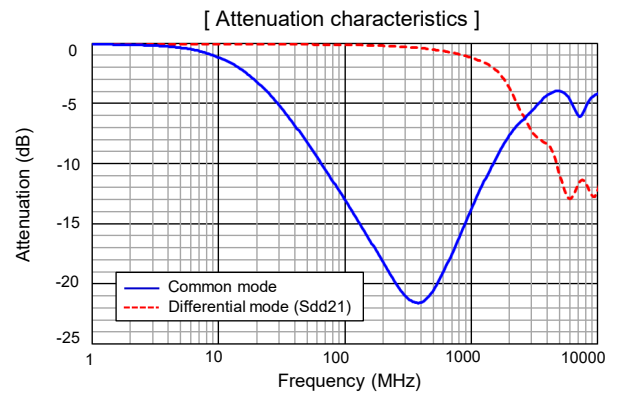
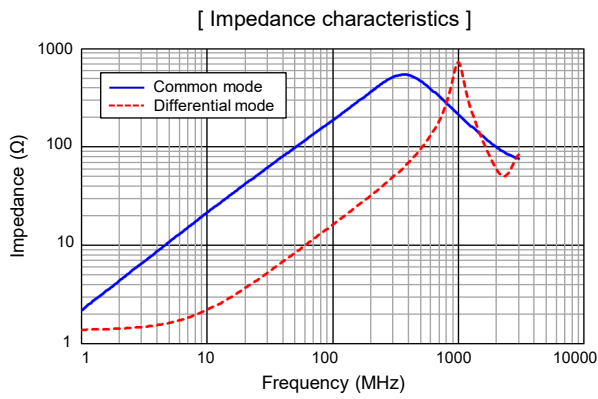

● Impedance measurement circuit

(A) Common mode

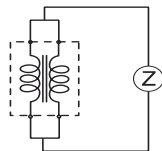

(B) Differential mode

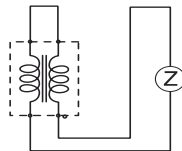

■ As for packaging methods, soldering conditions and safety precautions, please see data files

 This series is not a recommended product.  
Not recommended for new design.

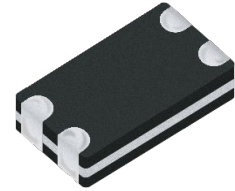

# Common Mode Noise Filters

## EXC34CG type

### Features

- Thin type, built-in filter circuit (L 2.0 mm×W 1.25 mm×H 0.50 mm)
- Noise suppression of high-speed differential transmission lines with little influence of waveform rounding on signal transmission
- Strong multilayer/sintered structure, excellent reflow resistance and high mounting reliability
- Lead, halogen and antimony-free
- RoHS compliant

### Recommended applications

- AV equipment (LCD-TV, DVD/Blu-ray drives), Information equipment (PCs, HDD, Printers)
- Noise suppression of high-speed differential data lines such as USB2.0, LVDS, HDMI and LAN

### Explanation of part numbers

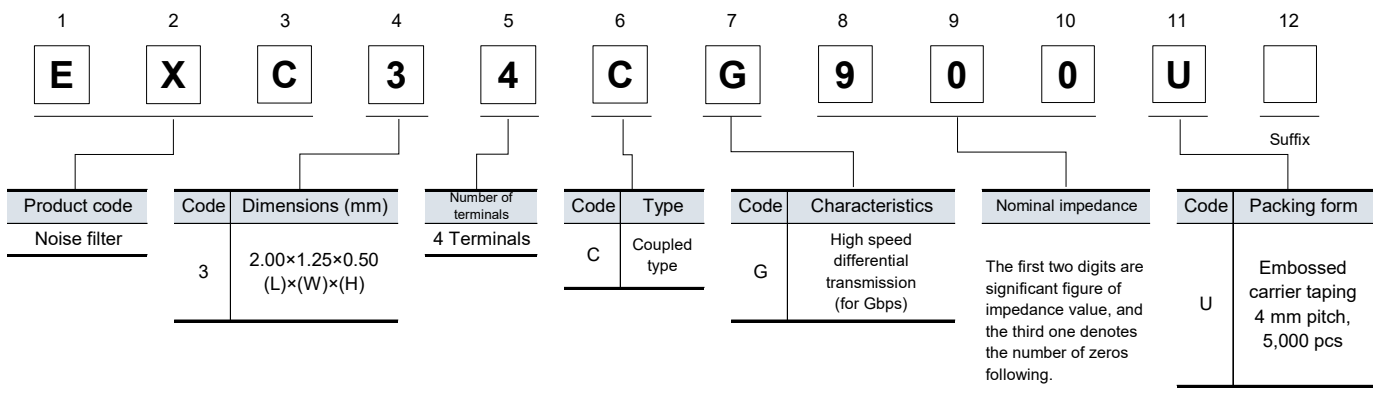

### Construction

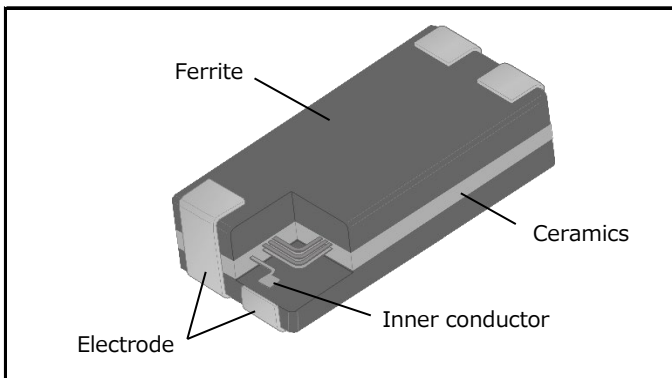

### Circuit configuration (No polarity)

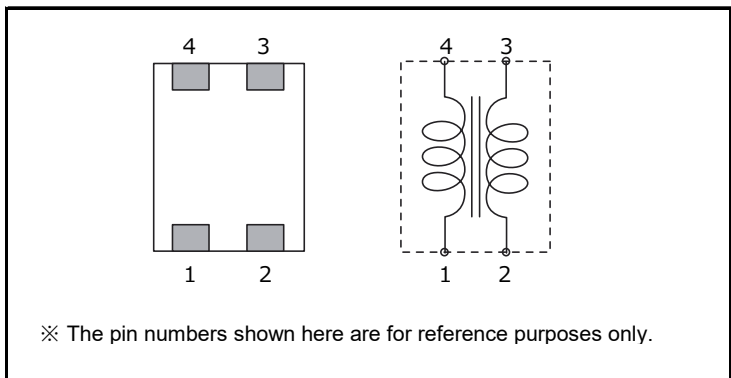

### Dimensions in mm (not to scale)

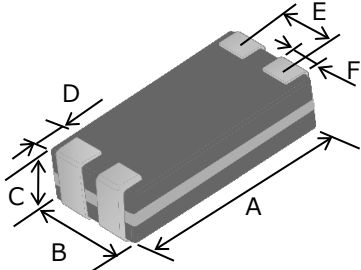

Part No. (inch size)	Dimensions						Mass (Weight) (mg/ pc.)
	A	B	C	D	E	F	
EXC34CG (0805)	2.00 ± 0.15	1.25 ± 0.15	0.50 ± 0.10	0.30 ± 0.20	0.80 ± 0.10	0.30 ± 0.15	5.0

Unit : mm

Ratings							
Part number	Impedance ( $\Omega$ ) at 100 MHz		Rated current (mA) DC	Rated voltage (V) DC	Insulation resistance (M $\Omega$ ) min.	Withstand voltage (V) DC	DC resistance ( $\Omega$ ) max.
	Common mode						
EXC34CG900U	90 $\Omega$ $\pm$ 25 %		100	5	10 M $\Omega$	125	3.0

● Category temperature range -40 °C to +85 °C

**Characteristics graph (Reference data)**

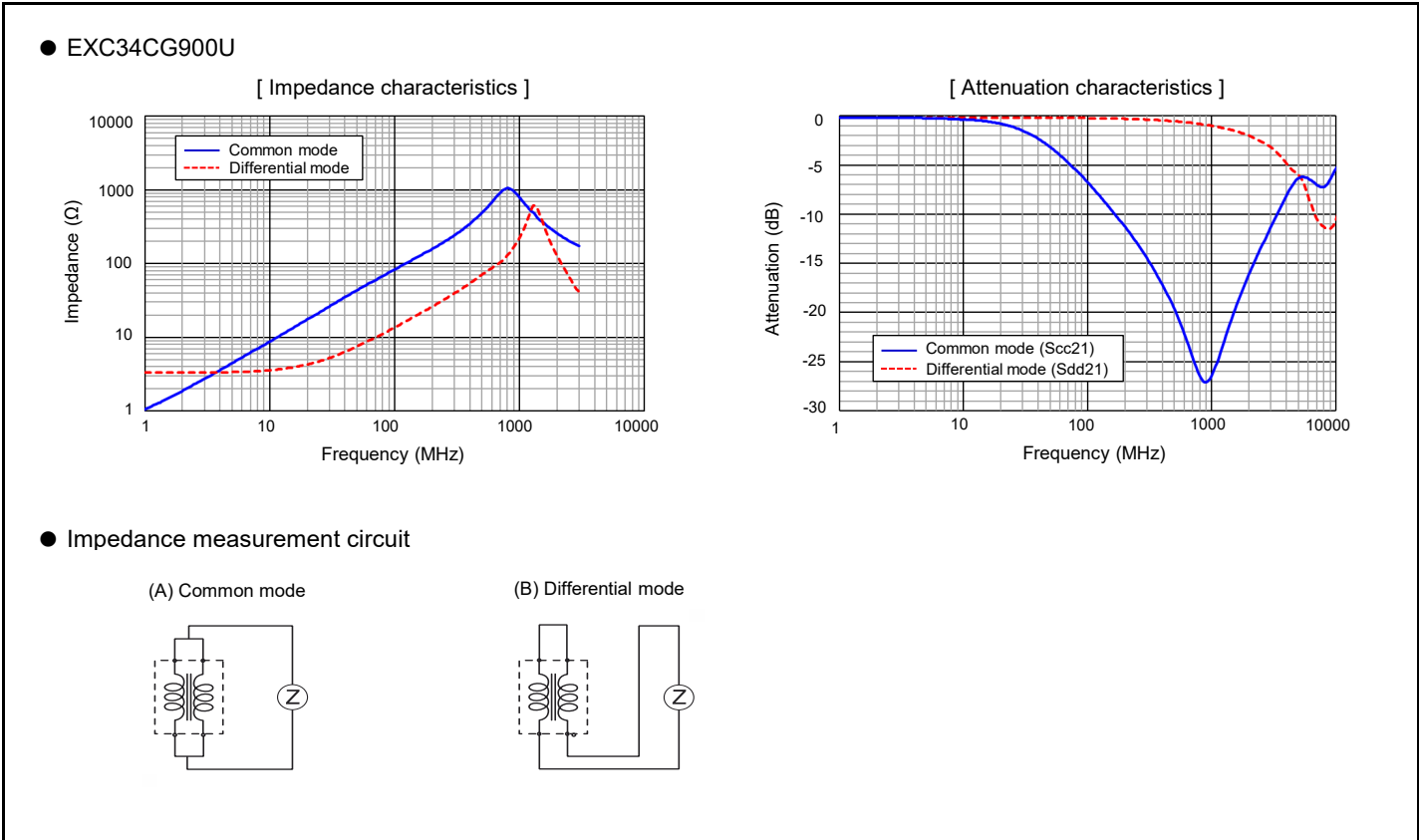

■ As for packaging methods, soldering conditions and safety precautions, please see data files

# Common Mode Noise Filters Array

## EXC18CE type



### Features

- Small and thin type (L 1.6 mm ×W 0.8 mm×H 0.4 mm)
- Noise suppression of high-speed differential transmission lines with little influence of waveform rounding on signal transmission
- Low DC resistance and low insertion loss
- Strong multilayer/sintered structure, excellent reflow resistance and high mounting reliability
- Lead, halogen and antimony-free
- RoHS compliant

### Recommended applications

- AV equipment (LCD-TV, DVD/Blu-ray drives), Information equipment (PCs, HDD, Printers)
- Noise suppression of high-speed differential data lines such as USB2.0, LVDS, HDMI and LAN

### Explanation of part numbers

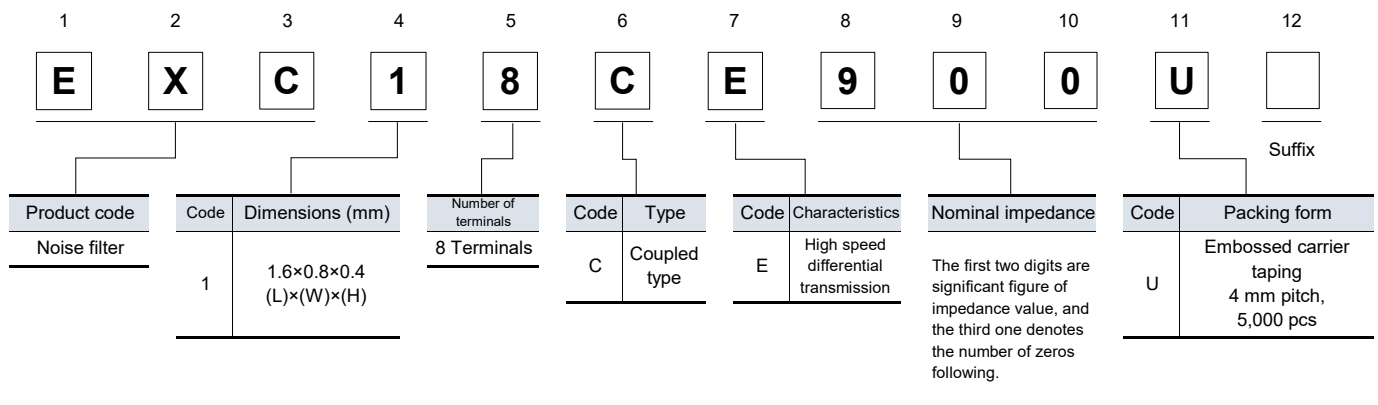

### Construction

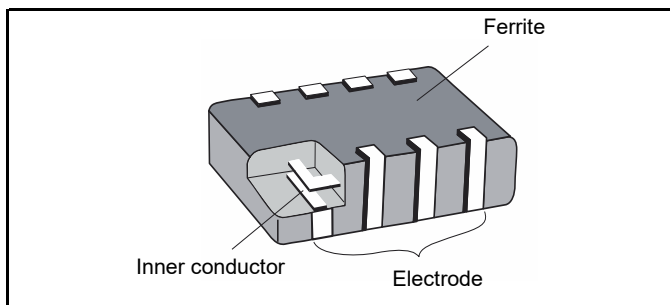

### Circuit configuration (No polarity)

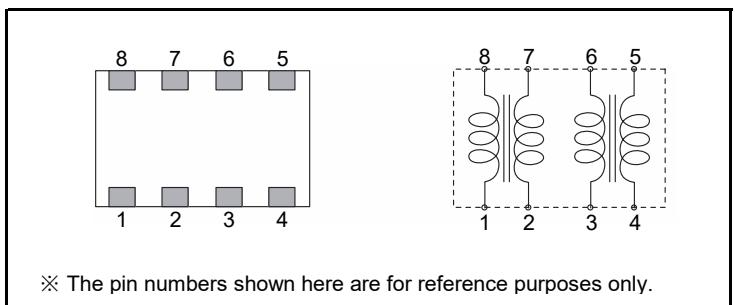

### Dimensions in mm (not to scale)

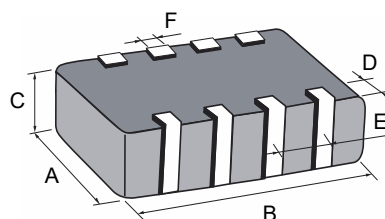

Unit : mm

Part No. (inch size)	Dimensions						Mass (Weight) (mg/ pc.)
	A	B	C	D	E	F	
EXC18CE (0603)	0.8 ± 0.1	1.6 ± 0.1	0.4 ± 0.1	0.2 ± 0.1	0.4 ± 0.1	0.2 ± 0.1	2.6

**Ratings**

Part number	Impedance ( $\Omega$ ) at 100 MHz		Rated voltage (V) DC	Rated current (mA) DC	DC resistance ( $\Omega$ ) max.
	Common mode	Differential mode			
EXC18CE650U	65 $\Omega$ $\pm$ 20 %	18 $\Omega$ max.	5	140	1.8
EXC18CE900U	90 $\Omega$ $\pm$ 20 %	20 $\Omega$ max.	5	130	2.0
EXC18CE201U	200 $\Omega$ $\pm$ 20 %	22 $\Omega$ max.	5	100	3.5

● Category temperature range  $-40^{\circ}\text{C}$  to  $+85^{\circ}\text{C}$

**Characteristics graph (Reference data)**

● EXC18CE650U

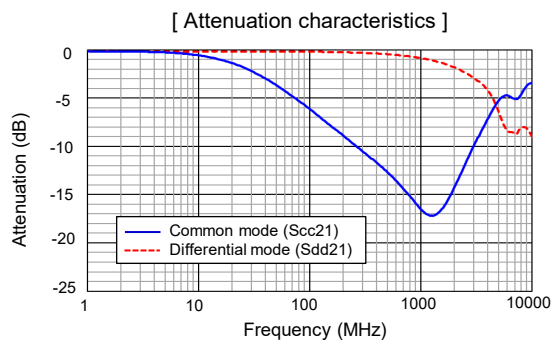
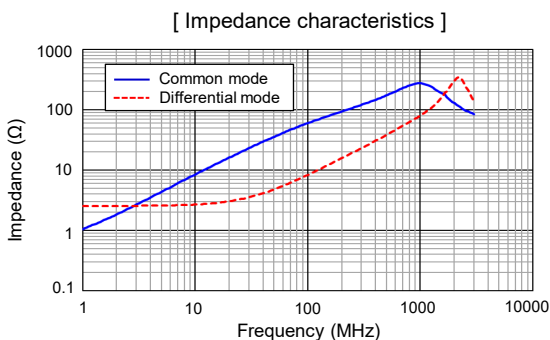

● EXC18CE900U

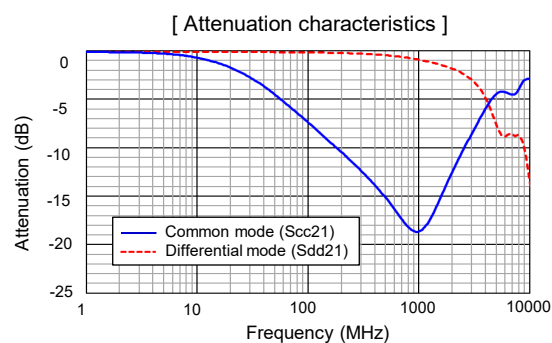
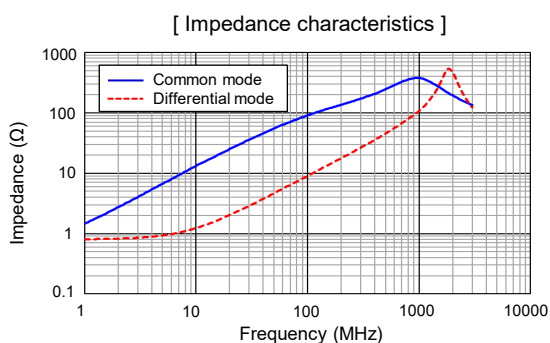

● EXC18CE201U

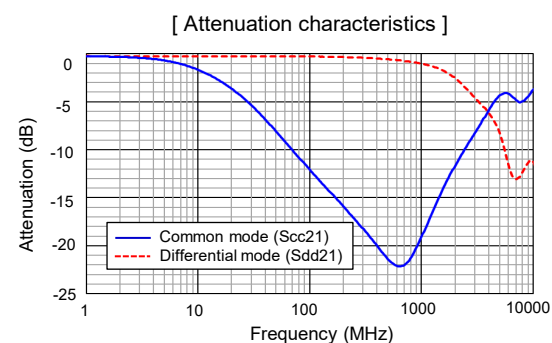
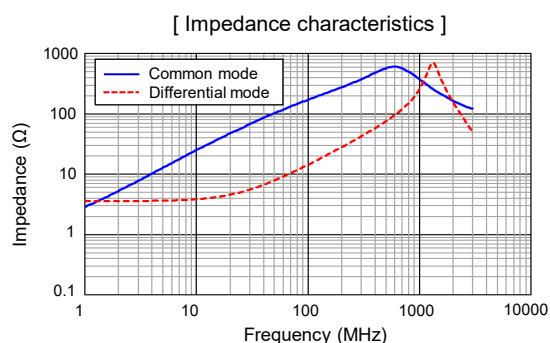

● Impedance measurement circuit

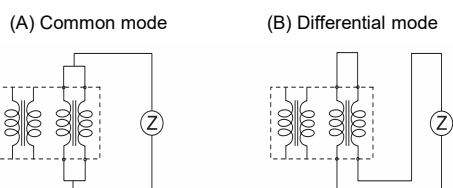

■ As for packaging methods, soldering conditions and safety precautions, please see data files



## Common Mode Noise Filters Array

### EXC18CG type

#### Features

- Small and thin type, two built-in filter circuit (L 1.6 mm ×W 0.8 mm×H 0.4 mm)
- Noise suppression of high-speed differential transmission lines with little influence of waveform rounding on signal transmission
- Low DC resistance and low insertion loss
- High-Q value and high impedance of GHz zone : EXC18CG type
- Strong multilayer/sintered structure, excellent reflow resistance and high mounting reliability
- Lead, halogen and antimony-free
- RoHS compliant

#### Recommended applications

- AV equipment (LCD-TV, DVD/Blu-ray drives), Information equipment (PCs, HDD, Printers)
- Noise suppression of high-speed differential data lines such as USB2.0, LVDS, HDMI and LAN

#### Explanation of part numbers

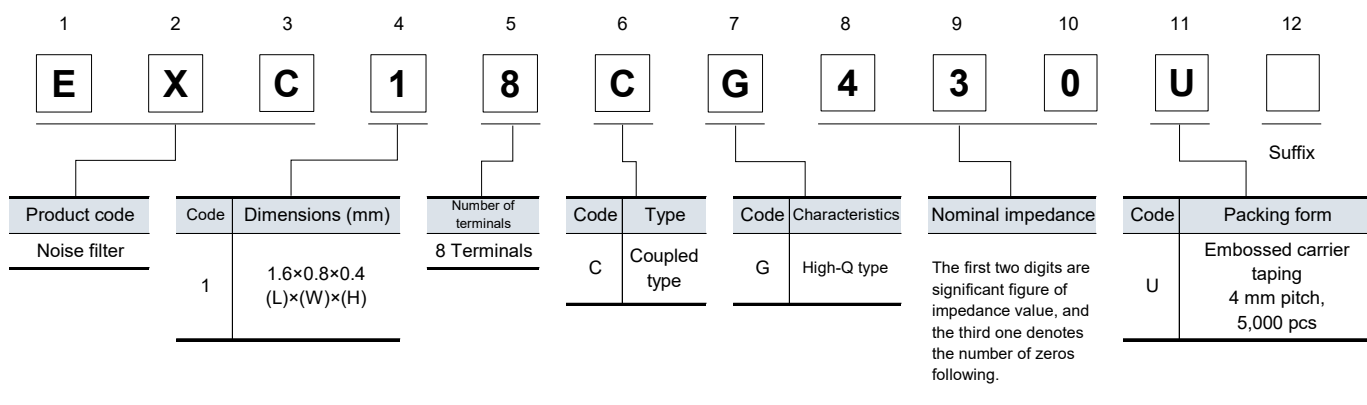

#### Construction

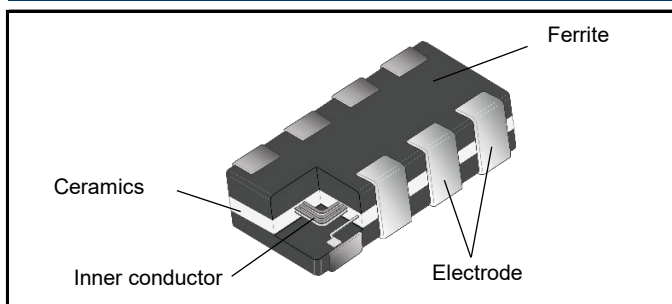

#### Circuit configuration (No polarity)

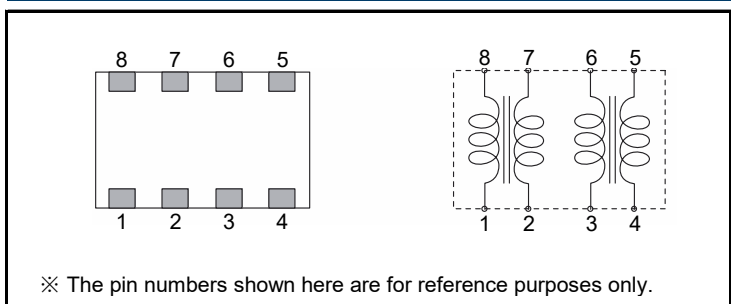

#### Dimensions in mm (not to scale)

Part No. (inch size)	Dimensions						Mass (Weight) (mg/ pc.)
	A	B	C	D	E	F	
EXC18CG (0603)	0.8 ± 0.1	1.6 ± 0.1	0.4 ± 0.1	0.2 ± 0.1	0.4 ± 0.1	0.2 ± 0.1	2.6

Unit : mm

**Ratings**

Part number	Impedance ( $\Omega$ ) at 100 MHz		Rated voltage (V) DC	Rated current (mA) DC	DC resistance ( $\Omega$ ) max.
	Common mode	Differential mode			
EXC18CG430U	43 $\Omega$ $\pm$ 25 %	15 $\Omega$ max.	5	100	2.7

● Category temperature range  $-40\text{ }^{\circ}\text{C}$  to  $+85\text{ }^{\circ}\text{C}$

**Characteristics graph (Reference data)**

● EXC18CG430U

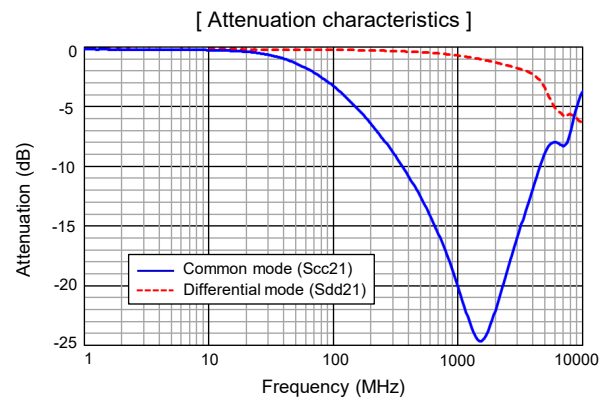
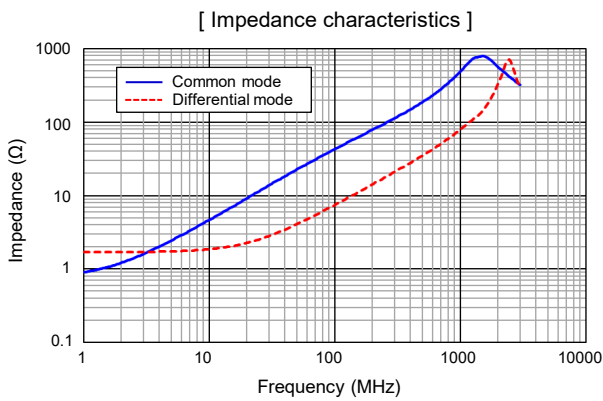

● Impedance measurement circuit

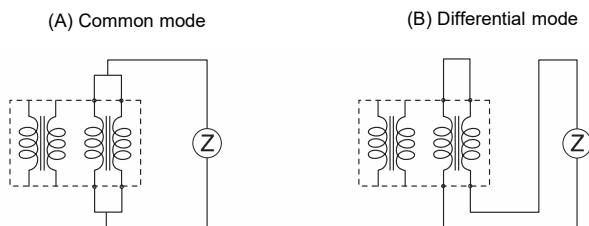

■ As for packaging methods, soldering conditions and safety precautions, please see data files



# Common Mode Noise Filters Array

## EXC28CH type

### Features

- Small and thin type (L 2.0 mm×W 1.0 mm×H 0.5 mm)
- Suppression of high frequency noise with little influence of waveform rounding on signal transmission, achieved by setting high cut-off frequency between 6 and 10 GHz
- Strong multilayer/sintered structure, excellent reflow resistance and high mounting reliability
- Lead, halogen and antimony-free
- RoHS compliant

### Recommended applications

- AV equipment (LCD-TV, DVD/Blu-ray drives), Information equipment (PCs, HDD, Printers)
- Noise suppression of high-speed differential data lines such as USB3.0, LVDS, HDMI and LAN

### Explanation of part numbers

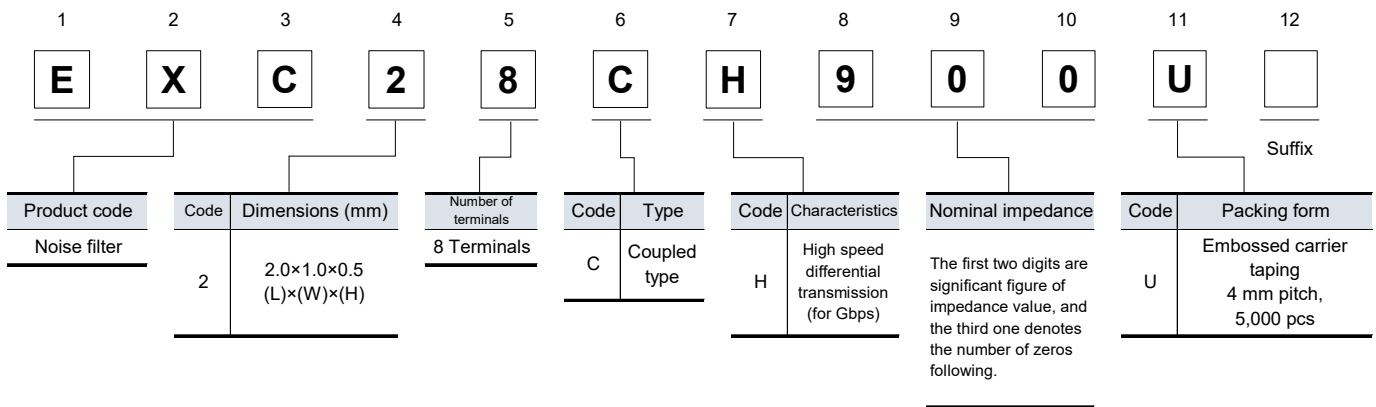

### Construction

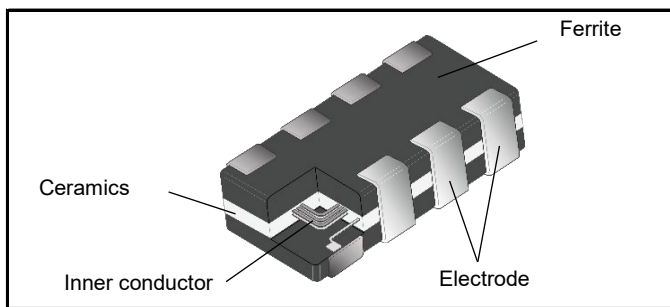

### Circuit configuration (No polarity)

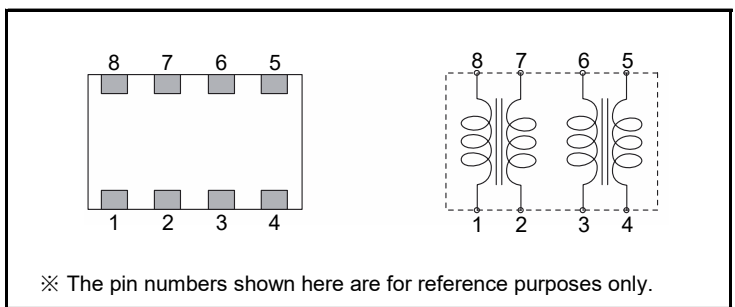

### Dimensions in mm (not to scale)

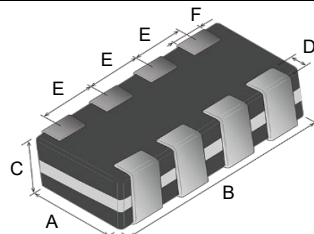

Unit : mm

Part No. (inch size)	Dimensions						Mass (Weight) (mg/ pc.)
	A	B	C	D	E	F	
EXC28CH (0804)	1.00 ± 0.15	2.0 ± 0.2	0.5 ± 0.1	0.2 ± 0.15	0.5 ± 0.1	0.25 ± 0.1	5.0

**Ratings**

Part number	Impedance ( $\Omega$ ) at 100 MHz		Cutoff frequency (GHz)	Rated voltage (V) DC	Rated current (mA) DC	DC resistance ( $\Omega$ ) max.
	Common mode	Differential mode				
EXC28CH500U	50 $\Omega$ $\pm$ 25 %	13 $\Omega$ max.	10 Typ.	5	160	1.5
EXC28CH900U	90 $\Omega$ $\pm$ 20 %	15 $\Omega$ max.	6 Typ.	5	130	2.5

● Category temperature range  $-40\text{ }^{\circ}\text{C}$  to  $+85\text{ }^{\circ}\text{C}$

**Characteristics graph (Reference data)**

● EXC28CH500U

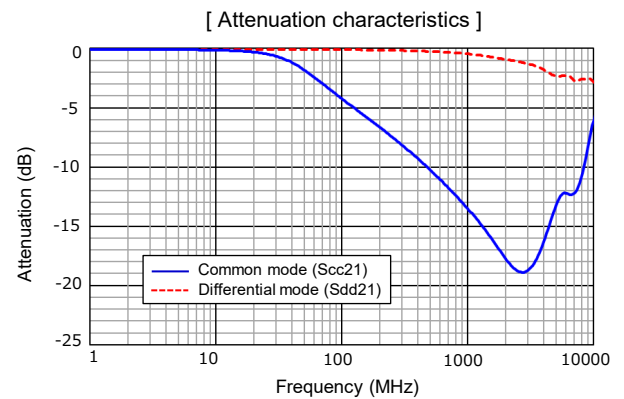
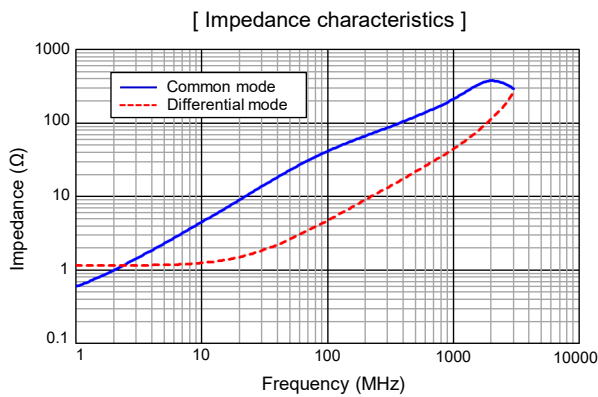

● EXC28CH900U

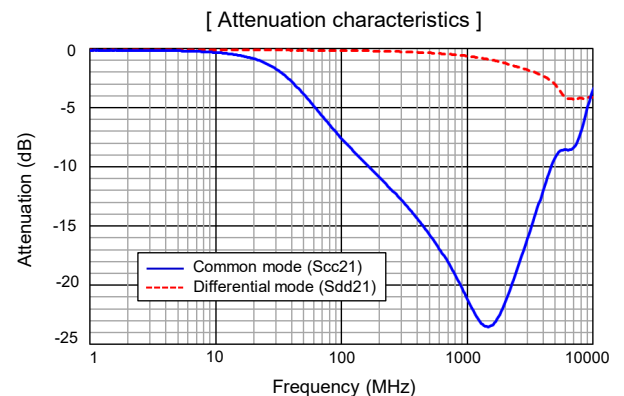
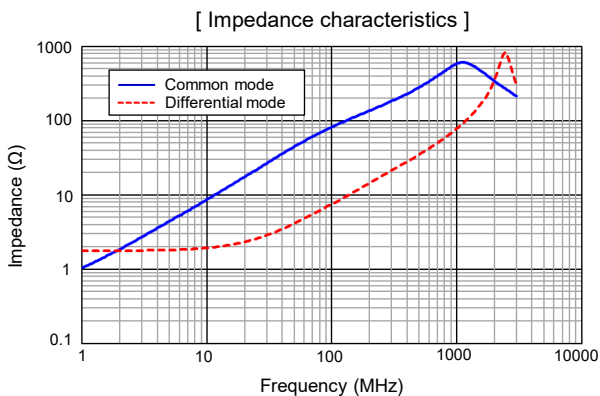

● Impedance measurement circuit

(A) Common mode

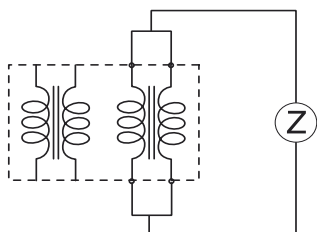

(B) Differential mode

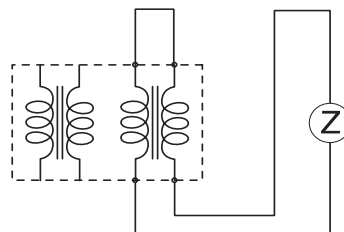

■ As for packaging methods, soldering conditions and safety precautions, please see data files

**!** This series is not a recommended product.  
Not recommended for new design.



# Common Mode Noise Filters Array

## EXC28CG type

### Features

- Small and thin type, two built-in filter circuit (L 2.0 mm×W 1.0 mm×H 0.5 mm)
- Prevention of weakening of transmission signals by controlling signal pass band as 3 GHz or above
- Prevention of reflection of transmission signals and noise radiation by controlling TDR characteristic impedance as 100 Ω
- Satisfaction of eye pattern standards of HDMI waveforms with capability to improve waveform fluctuations of Jitter and phase shift etc
- Elimination of radiation noises from high-speed differential transmissions
- Magnetic shield type with no leakage
- RoHS compliant

### Recommended applications

- AV equipment (LCD-TV, DVD/Blu-ray drives), Information equipment (PCs, HDD), Communications equipment (Mobile phones, Smartphones)
- Noise suppression of high-speed differential data lines such as HDMI, SATA and LAN

### Explanation of part numbers

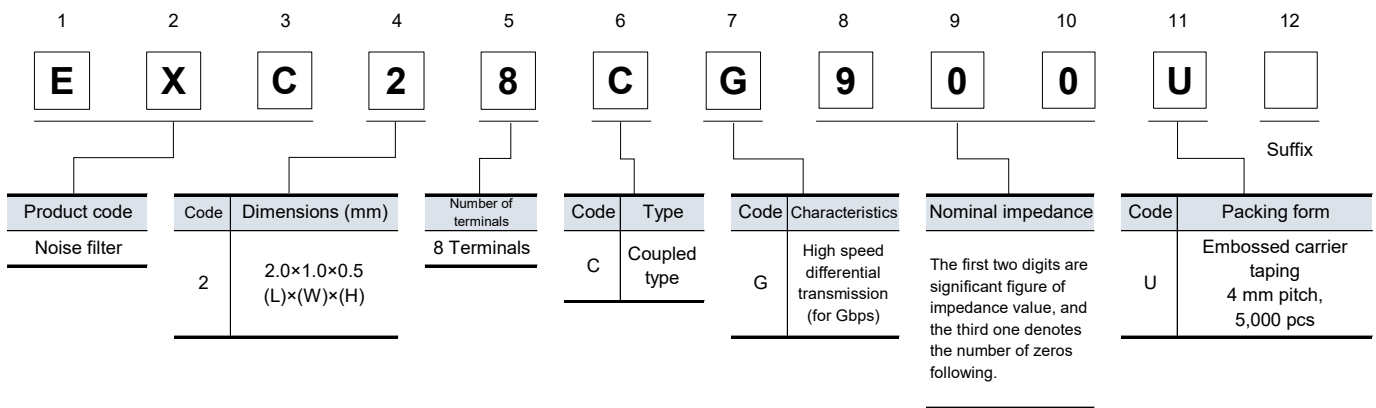

### Construction

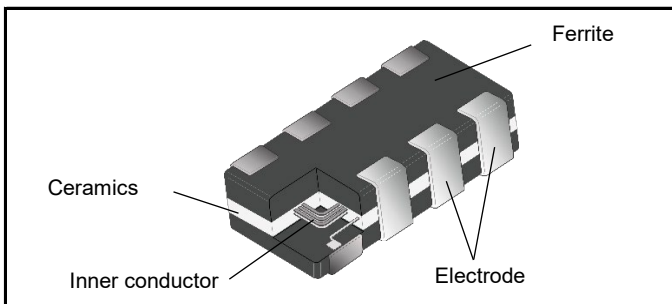

### Circuit configuration (No polarity)

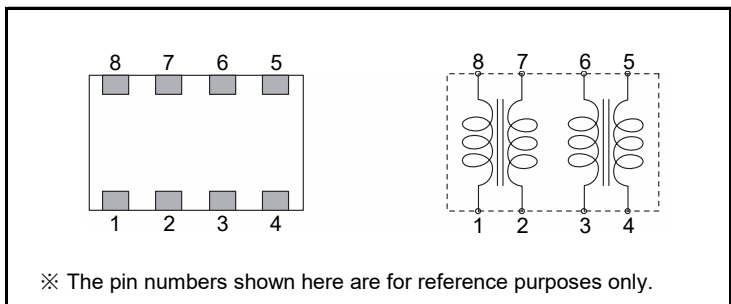

### Dimensions in mm (not to scale)

Part No. (inch size)	Dimensions						Mass (Weight) (mg/ pc.)
	A	B	C	D	E	F	
EXC28CG (0804)	1.00 ± 0.15	2.0 ± 0.2	0.5 ± 0.1	0.2 ± 0.15	0.5 ± 0.1	0.25 ± 0.1	5.0

Unit : mm

**Ratings**

Part number	Impedance ( $\Omega$ ) at 100 MHz		Rated voltage (V) DC	Rated current (mA) DC	DC resistance ( $\Omega$ ) max.
	Common mode	Differential mode			
EXC28CG240U	24 $\Omega \pm 25\%$	15 $\Omega$ max.	5	160	1.5
EXC28CG900U	90 $\Omega \pm 25\%$	17 $\Omega$ max.	5	130	3.0

● Category temperature range  $-40\text{ }^{\circ}\text{C}$  to  $+85\text{ }^{\circ}\text{C}$

**Characteristics graph (Reference data)**

● EXC28CG240U

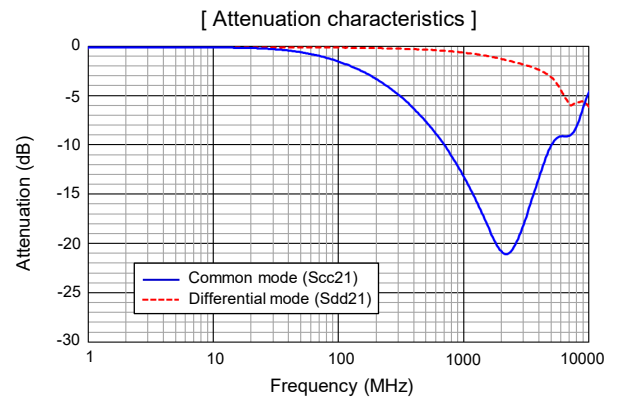
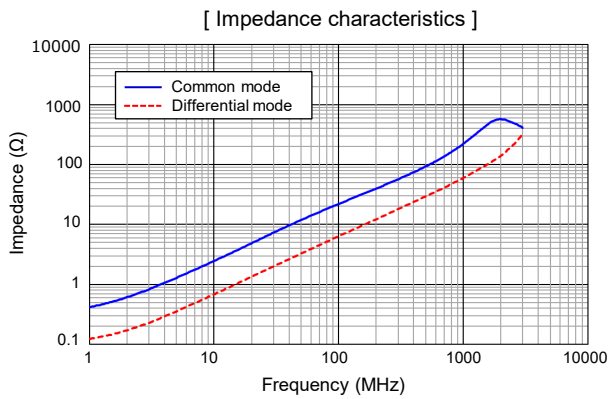

● EXC28CG900U

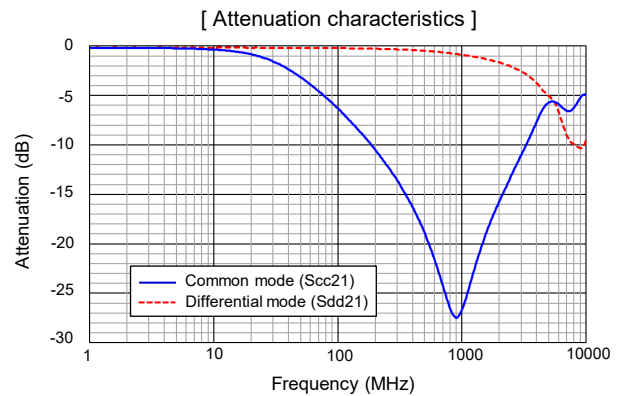
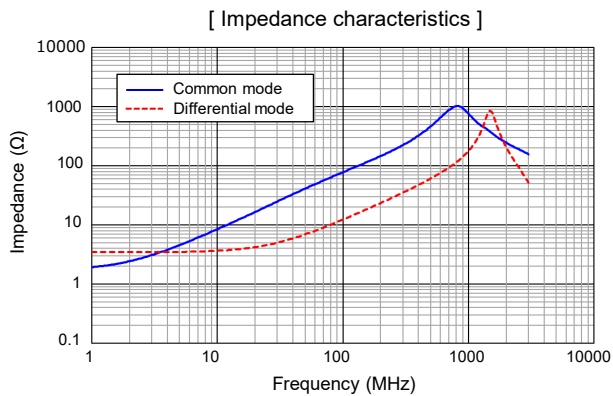

● Impedance measurement circuit

(A) Common mode

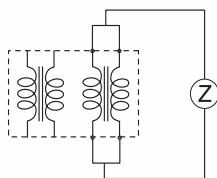

(B) Differential mode

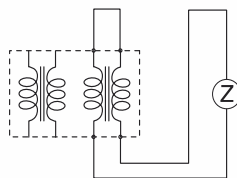

■ As for packaging methods, soldering conditions and safety precautions, please see data files

# Common Mode Noise Filters Array

## EXC28CE type



### Features

- Small and thin type (L 2.0 mm×W 1.0 mm×H 0.5 mm)
- Elimination of radiation noises from high-speed differential transmissions
- Magnetic shield type with no leakage
- Strong multilayer/sintered structure, excellent reflow resistance and high mounting reliability
- Lead, halogen and antimony-free
- RoHS compliant

### Recommended applications

- AV equipment (LCD-TV, DVD/Blu-ray drives), Information equipment (PCs, HDD, Printers), Communications equipment (Mobile phones, Smartphones)
- Noise suppression of high-speed differential data lines such as USB2.0 and LVDS

### Explanation of part numbers

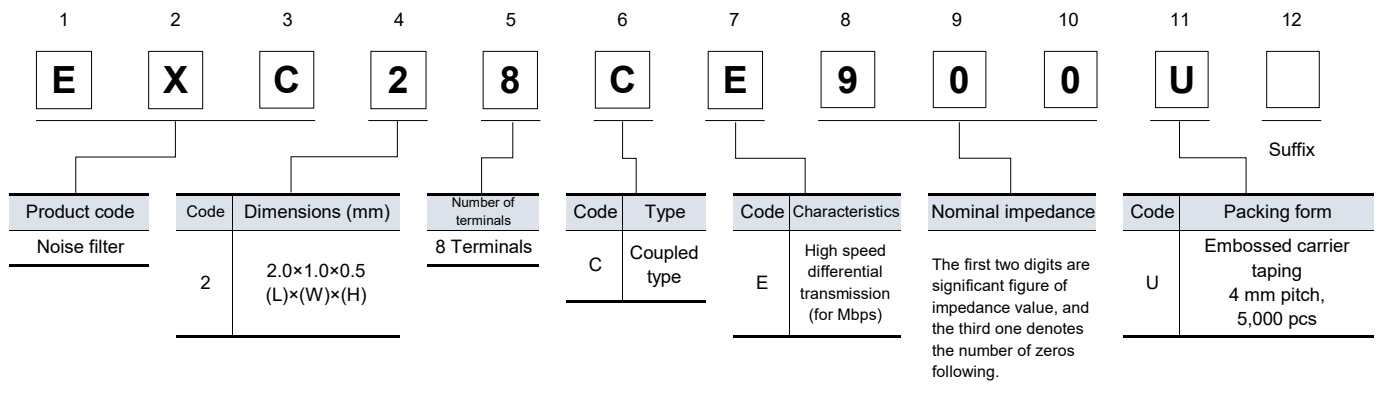

### Construction

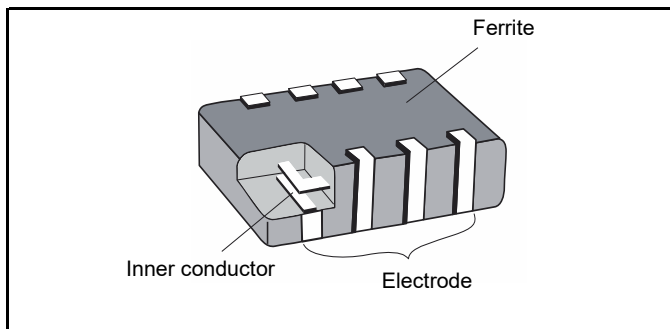

### Circuit configuration (No polarity)

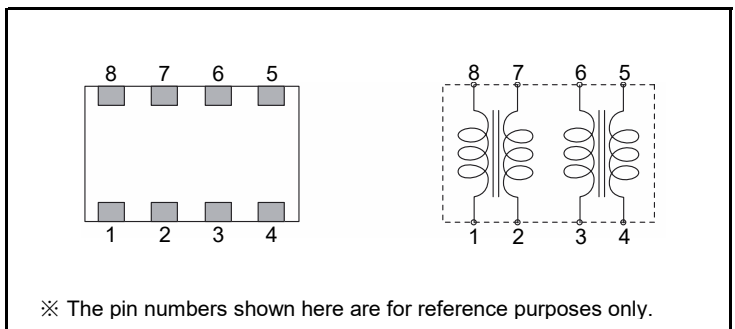

### Dimensions in mm (not to scale)

Part No. (inch size)	Dimensions						Mass (Weight) (mg/ pc.)
	A	B	C	D	E	F	
EXC28CE (0804)	1.00 ± 0.15	2.0 ± 0.2	0.5 ± 0.1	0.2 ± 0.15	0.5 ± 0.1	0.25 ± 0.1	5.0

Unit : mm

**Ratings**

Part number	Impedance ( $\Omega$ ) at 100 MHz		Rated voltage (V) DC	Rated current (mA) DC	DC resistance ( $\Omega$ ) max.
	Common mode	Differential mode			
EXC28CE900U	90 $\Omega \pm 25\%$	15 $\Omega$ max.	5	160	1.5
EXC28CE121U	120 $\Omega \pm 25\%$	18 $\Omega$ max.	5	140	2.0
EXC28CE201U	200 $\Omega \pm 25\%$	20 $\Omega$ max.	5	130	2.5

● Category temperature range  $-40\text{ }^{\circ}\text{C}$  to  $+85\text{ }^{\circ}\text{C}$

**Characteristics graph (Reference data)**

● EXC28CE900U

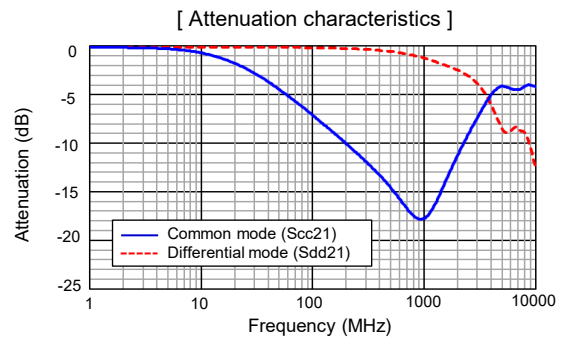
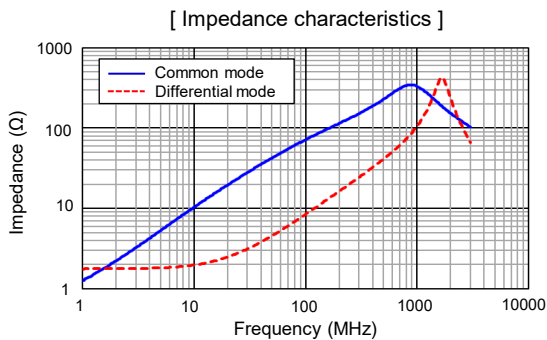

● EXC28CE121U

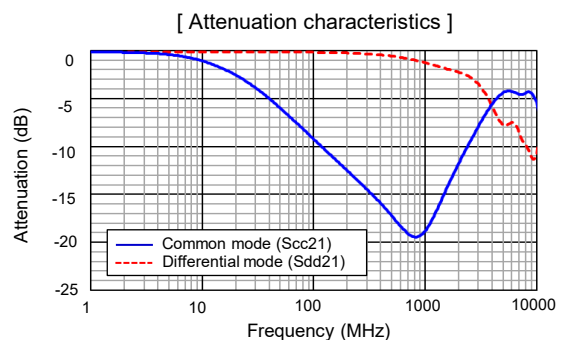
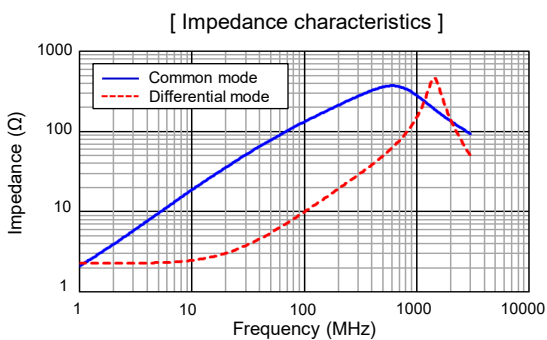

● EXC28CE201U

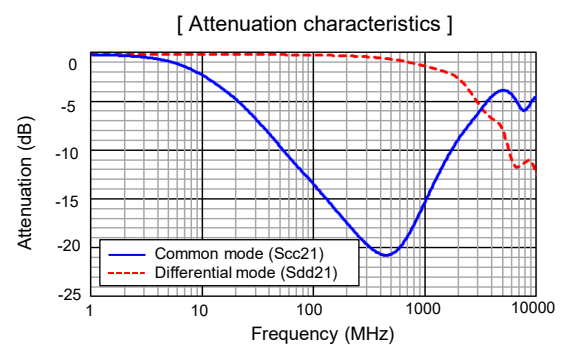
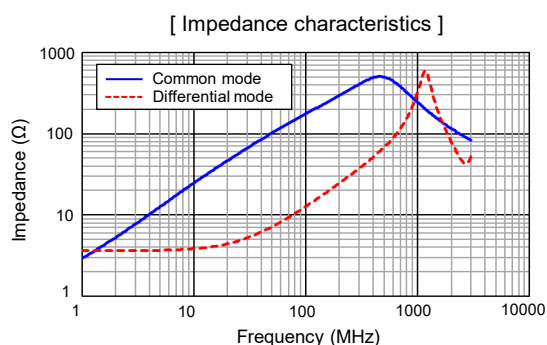

● Impedance measurement circuit

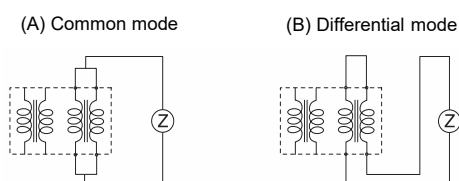

■ As for packaging methods, soldering conditions and safety precautions, please see data files

# Common Mode Noise Filters · Array / Packaging methods

## Packaging methods (Taping)

● Standard quantity

\*: EXC14CE support pressed and embossed carrier taping, the other EXC14C type only support embossed carrier taping.

Type	Part number	Size (inch)	Kind of taping	Pitch (P <sub>1</sub> ) (mm)	Quantity (pcs / reel)
Single	EXCX4C	0202	Pressed carrier taping	2	10,000
	EXC14C*	0302	Pressed / Embossed carrier taping		
	EXC16C	0403	Embossed carrier taping	4	
	EXC24C	0504			
Array	EXC34C	0805			5,000
	EXC18C	0603			
	EXC28C	0804			

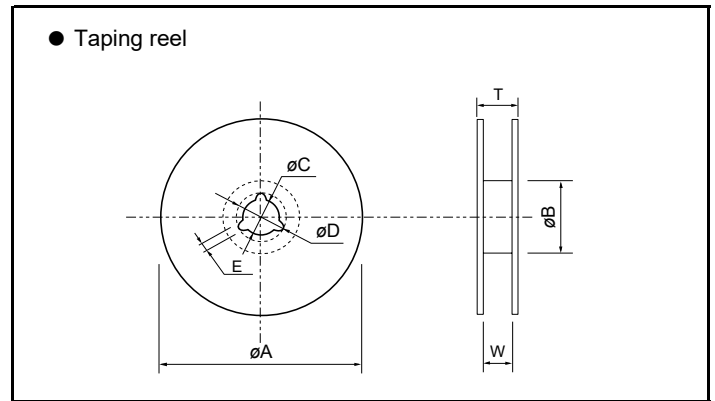
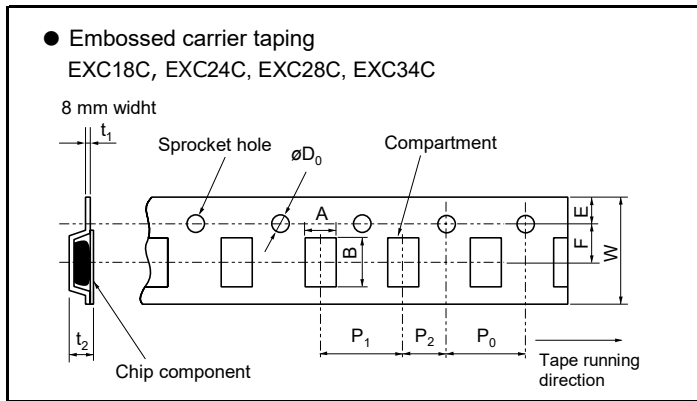
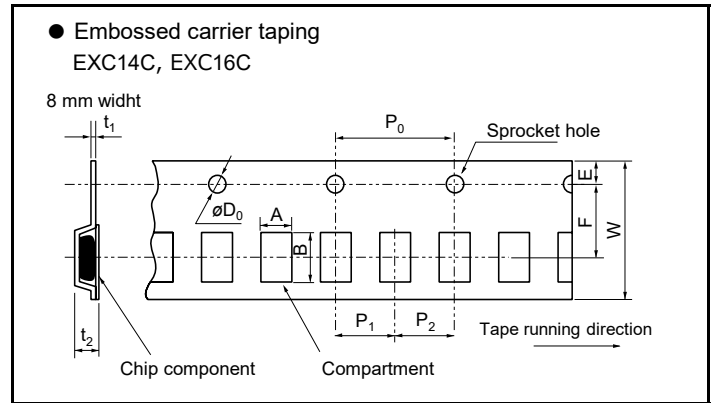
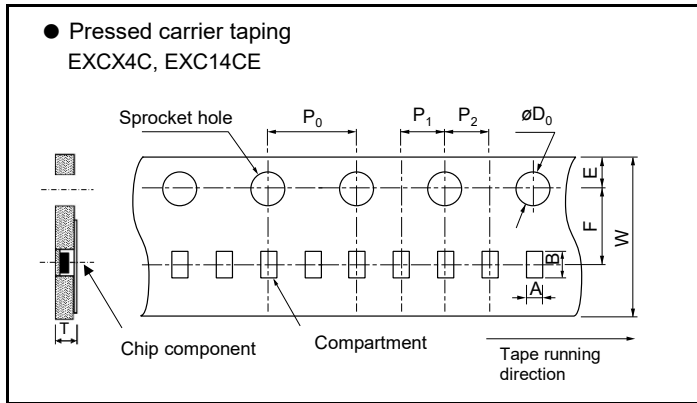

### Pressed carrier taping

Unit : mm

Part number	A	B	W	F	E	P <sub>1</sub>	P <sub>2</sub>	P <sub>0</sub>	øD <sub>0</sub>	T
EXCX4C	0.60±0.1	0.73±0.1	8.0±0.2	3.50±0.05	1.75±0.1	2.0±0.1	1.0±0.1	2.0±0.1	1.5 <sup>+0.1</sup> <sub>0</sub>	0.68 Max.
EXC14CE	0.77±0.1	0.97±0.1	8.0±0.2	3.50±0.05	1.75±0.1	2.0±0.1	1.0±0.1	2.0±0.1	1.5 <sup>+0.1</sup> <sub>0</sub>	0.90 Max.

### Embossed carrier taping

Unit : mm

Part number	A	B	W	F	E	P <sub>1</sub>	P <sub>2</sub>	P <sub>0</sub>	øD <sub>0</sub>	t <sub>1</sub>	t <sub>2</sub>
EXC14C	0.75±0.1	0.95±0.1	8.0±0.2	3.50±0.05	1.75±0.10	2.0±0.1	1.0±0.1	2.0±0.1	1.5 <sup>+0.1</sup> <sub>0</sub>	0.25±0.05	0.85±0.15
EXC16C	0.77±0.1	0.99±0.1									0.80±0.15
EXC18C	1.00±0.1	1.80±0.1	8.0±0.2	3.5±0.1	1.75±0.10	4.0±0.1	2.0±0.1	4.0±0.1	1.5 <sup>+0.1</sup> <sub>0</sub>	0.25±0.05	0.80±0.05
EXC24C	1.20±0.15	1.45±0.15									0.90±0.15
EXC28C		2.25±0.15									
EXC34C	1.50±0.2	2.30±0.20									

### Standard reel dimensions

Unit : mm

Part number	øA	øB	øC	øD	E	W	T
EXCX4C	180.0±3.0	60.0±1.0	13.0±0.2	21.0±0.8	2.0±0.5	9.0±0.3	11.4±1.0
EXC14C			13.0±0.5				11.4±1.5
EXC16C							
EXC18C							
EXC24C							
EXC28C							
EXC34C							

Design and specifications are each subject to change without notice. Ask factory for the current technical specifications before purchase and/or use.  
Should a safety concern arise regarding this product, please be sure to contact us immediately.

31-Oct-23

**Recommended land pattern design**

● Single

EXCX4C, EXC14C, EXC24C, EXC34C

EXC16C

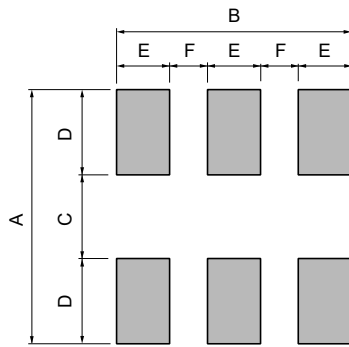
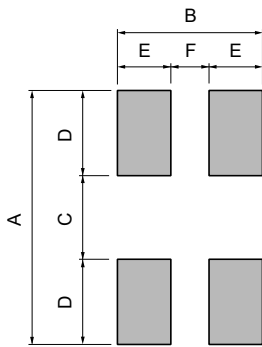

● Array

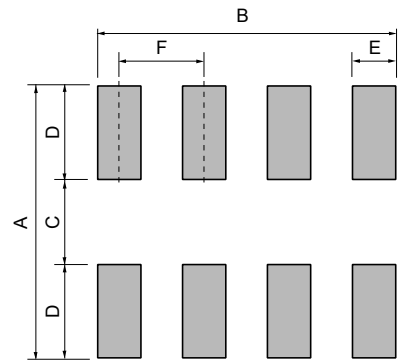

Part number	Dimensions					
	A	B	C	D	E	F
EXCX4C	0.80 to 0.90	0.60 to 0.75	0.20 to 0.30	0.30	0.20 to 0.25	0.20 to 0.25
EXC14C	0.80 to 1.00	0.80	0.30	0.25 to 0.35	0.30	0.20
EXC24C	1.60 to 2.00	0.95	0.70	0.45 to 0.65	0.35	0.25
EXC34C	2.60	1.20	1.10	0.75	0.40	0.40
EXC16C	0.99	0.85	0.33	0.33	0.15	0.20

Part number	Dimensions					
	A	B	C	D	E	F
EXC18C	1.4	1.4	0.4	0.5	0.2	0.4
EXC28C	1.4	1.75	0.4	0.5	0.25	0.5

Unit : mm

**Recommended soldering conditions**

Recommendations and precautions are described below

● Recommended soldering conditions for reflow

- Reflow soldering shall be performed a maximum of two times.
- Please contact us for additional information when used in conditions other than those specified.
- Please measure the temperature of the terminals and study every kind of solder and printed circuit board for solderability before actual use.

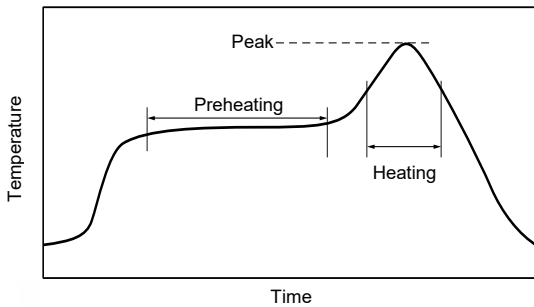

For soldering (Example : Sn-37Pb)

	Temperature	Time
Preheating	140 °C to 160 °C	60 s to 120 s
Main heating	Above 200 °C	30 s to 40 s
Peak	235 ± 10 °C	max. 10 s

For lead-free soldering (Example :Sn-3Ag-0.5Cu)

	Temperature	Time
Preheating	150 °C to 170 °C	60 s to 120 s
Main heating	Above 230 °C	30 s to 40 s
Peak	max. 260 °C	max. 10 s

● Flow soldering

- We do not recommend flow soldering, because flow soldering may cause bridges between the electrodes.

《Repair with hand soldering》

- Preheat with a blast of hot air or similar method. Use a soldering iron with a tip temperature of 350 °C or less. Solder each electrode for 3 seconds or less.
- Never touch this product with the tip of a soldering iron.



## 2 Mode Noise Filters EXC14CP type

### Features

- Small size and low-profile : 0302 inch size (L 0.85 mm×W 0.65 mm×H 0.45 mm)
- Burst/radiation noise filtering for audio circuits
- The optimally magnetic-coupled ferrite beads allow for the filtering of both common and normal mode noises
- The strong multi-layer structure provides high resistance to reflow soldering heat and a high mounting reliability
- RoHS compliant

### Recommended applications

- Smart phones, Tablet PCs, DSC and Portable Music Player
- Noise suppression of burst noise of Receiver/Microphone and D-class power amplifier

### Explanation of part numbers

1	2	3	4	5	6	7	8	9	10	11	12
E	X	C	1	4	C	P	2	2	1	U	
Product code Noise filter		Code 1	Dimensions (mm) 0.85×0.65×.045 (L)×(W)×(H)	Number of terminals 4 Terminals	Code C	Type Coupled type	Code P	Characteristics Low DCR type	Nominal impedance The first two digits are significant figure of impedance value, and the third one denotes the number of zeros following.	Code U	Packing form Embossed carrier taping 2 mm pitch, 10,000 pcs

### Construction

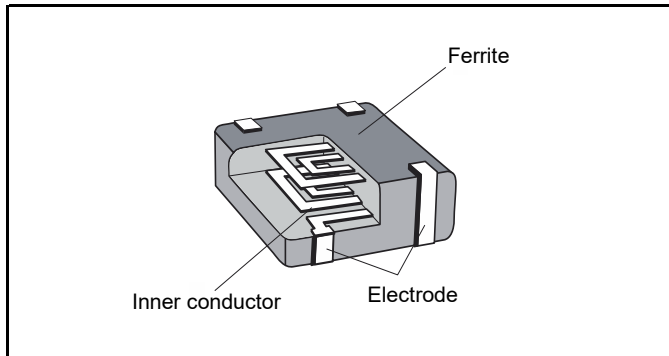

### Circuit configuration (No polarity)

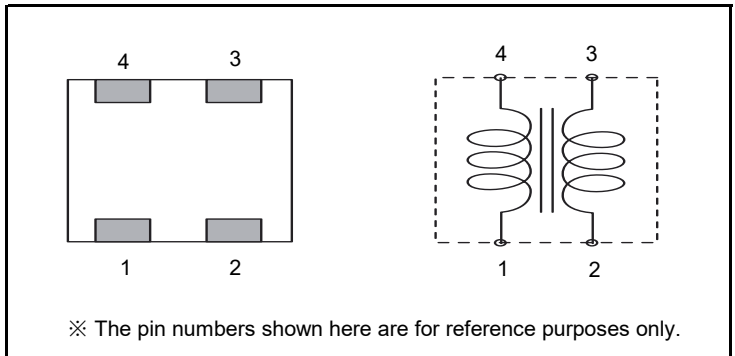

### Dimensions in mm (not to scale)

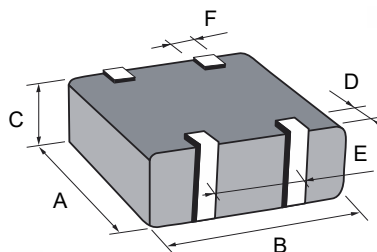

Unit : mm

Part No. (inch size)	Dimensions						Mass (Weight) (mg/ pc.)
	A	B	C	D	E	F	
EXC14CP (0302)	0.65 ± 0.05	0.85 ± 0.05	0.45 ± 0.05	0.10 min.	0.50 ± 0.10	0.27 ± 0.10	1.2

**Ratings**

Part number	Impedance ( $\Omega$ ) at 100 MHz		Rated voltage (V) DC	Rated current (mA) DC	DC resistance ( $\Omega$ ) max.
	Open mode	Common mode			
EXC14CP121U	120 $\Omega$ $\pm$ 30 %	75 $\Omega$ $\pm$ 25 %	5	300	0.5
EXC14CP221U	220 $\Omega$ $\pm$ 30 %	140 $\Omega$ $\pm$ 25 %		200	0.7

● Category temperature range  $-40\text{ }^{\circ}\text{C}$  to  $+85\text{ }^{\circ}\text{C}$

**Characteristics graph (Reference data)**

● EXC14CP121U

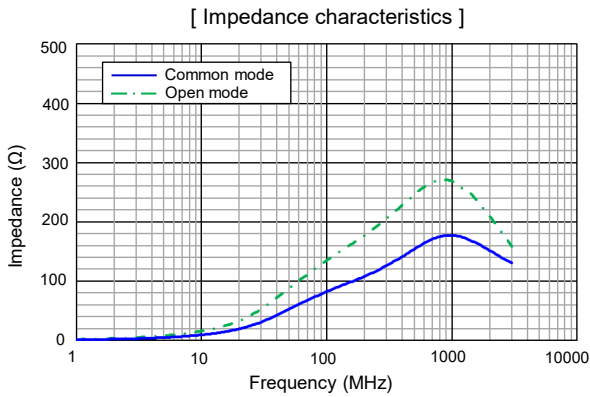

● EXC14CP221U

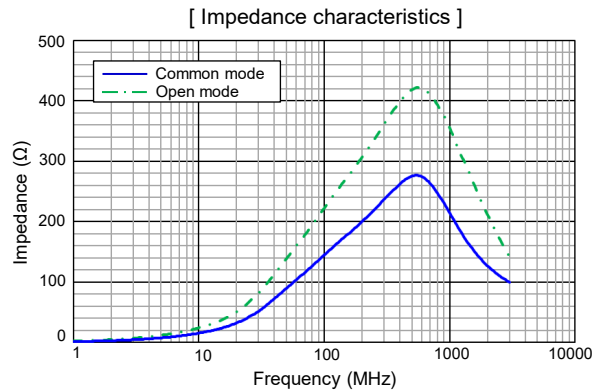

● Impedance measurement circuit

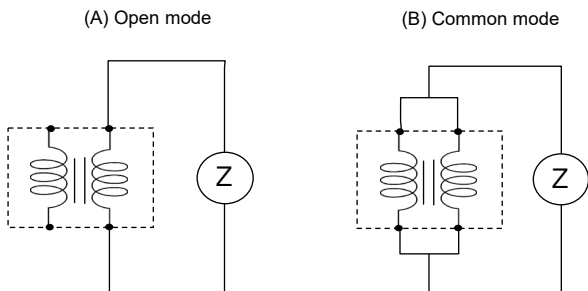

■ As for packaging methods, soldering conditions and safety precautions, please see data files



## 2 Mode Noise Filters

### EXC24CB/CP/CN type

#### Features

- Burst/radiation noise filtering for audio circuits
- The optimally magnetic-coupled ferrite beads allow for the filtering of both common and normal mode noises
- The strong multi-layer structure provides high resistance to reflow soldering heat and a high mounting reliability
- Magnetic shield type
- High Impedance : 220 to 1 kΩ (EXC24CB type)
- Low Resistance Value : 0.4 Ω max. (EXC24CP type)
- High Impedance : 600 Ω, Low Resistance Value : 0.9 Ω max. (EXC24CN type)
- RoHS compliant

#### Recommended applications

- Smart phones, Tablet PCs, DSC and Portable Music Player
- Noise suppression of burst noise of Receiver/Microphone and D-class power amplifier

#### Explanation of part numbers

- EXC24 CB/CP type

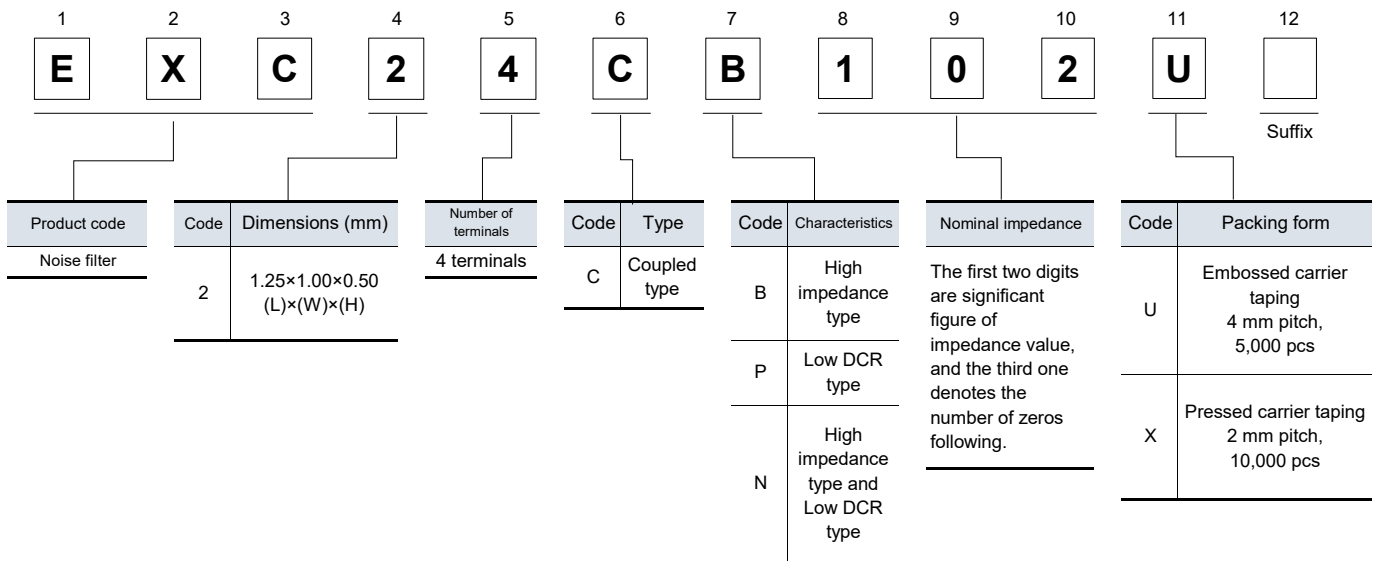

## 2 Mode Noise Filters EXC24CB/CP/CN type

### Construction

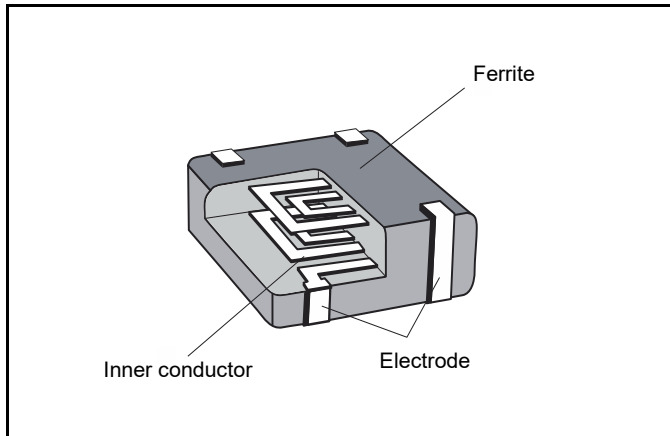

### Circuit configuration (No polarity)

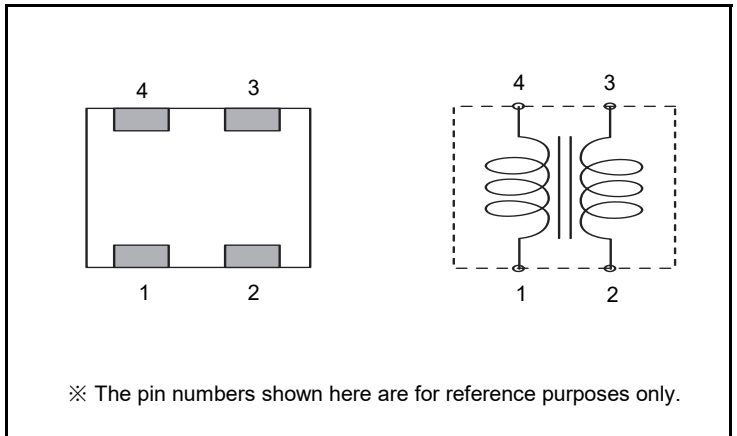

### Dimensions in mm (not to scale)

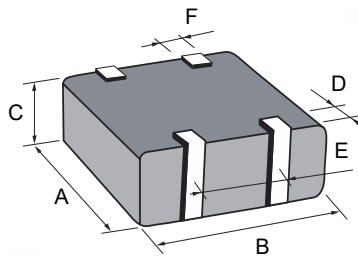

Unit : mm

Part No. (inch size)	Dimensions						Mass (Weight) (mg/ pc.)
	A	B	C	D	E	F	
EXC24C	1.00 ± 0.15	1.25 ± 0.15	0.50 ± 0.10	0.20 ± 0.15	0.65 ± 0.10	0.35 ± 0.10	3.0

### Ratings

Part number	Impedance (Open mode)		Rated voltage (V) DC	Rated current (mA) DC	DC resistance (Ω) max.
	(Ω) at 100 MHz	Tolerance (%)			
EXC24CP121U	120	± 25	5	500	0.3
EXC24CP221U	220			350	0.4
EXC24CB221U	220			100	0.7
EXC24CB102U	1000			50	1.5

Part number	Impedance (Common mode)		Rated voltage (V) DC	Rated current (mA) DC	DC resistance (Ω) max.
	(Ω) at 100 MHz	Tolerance (%)			
EXC24CN601X	600	± 25	5	200	0.9

- Category temperature range -40 °C to +85 °C

Characteristics graph (Reference data)

● EXC24CP121U

[ Impedance characteristics ]

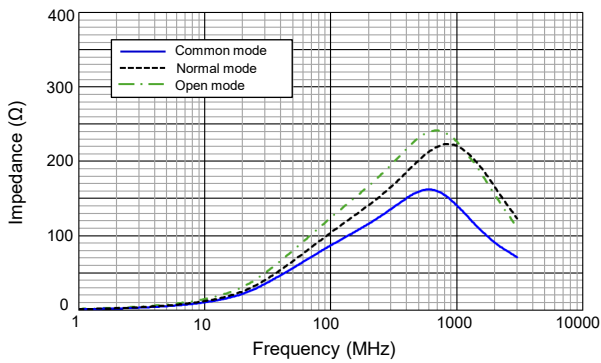

● EXC24CP221U

[ Impedance characteristics ]

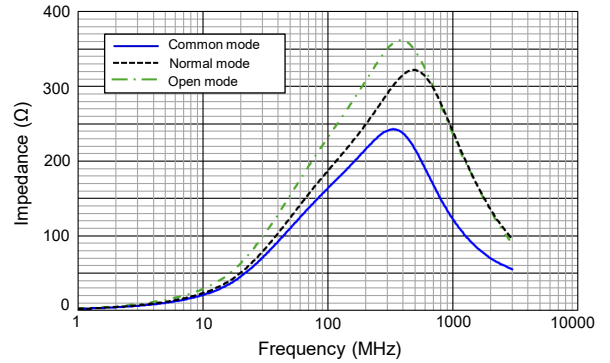

● EXC24CB221U

[ Impedance characteristics ]

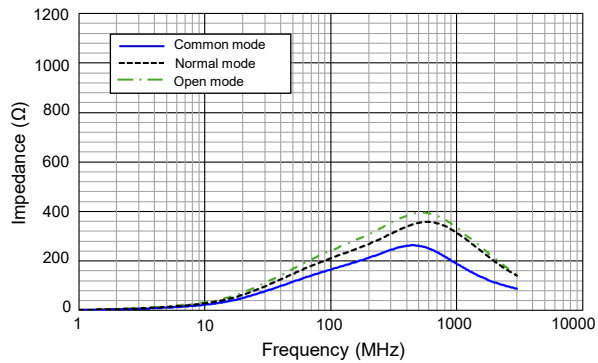

● EXC24CB102U

[ Impedance characteristics ]

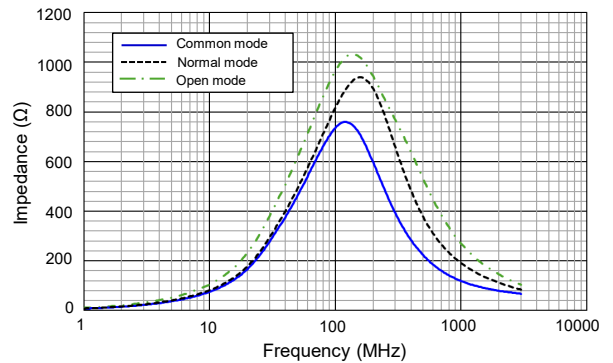

● EXC24CN601X

[ Impedance characteristics ]

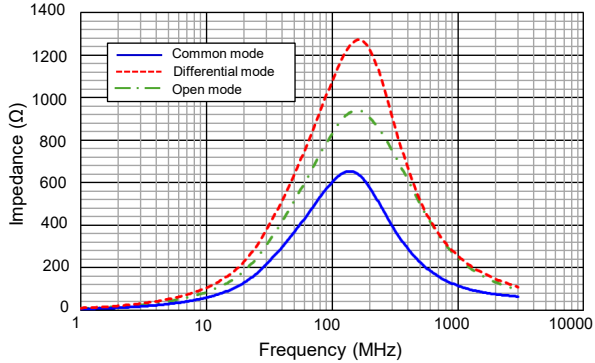

● Impedance measurement circuit

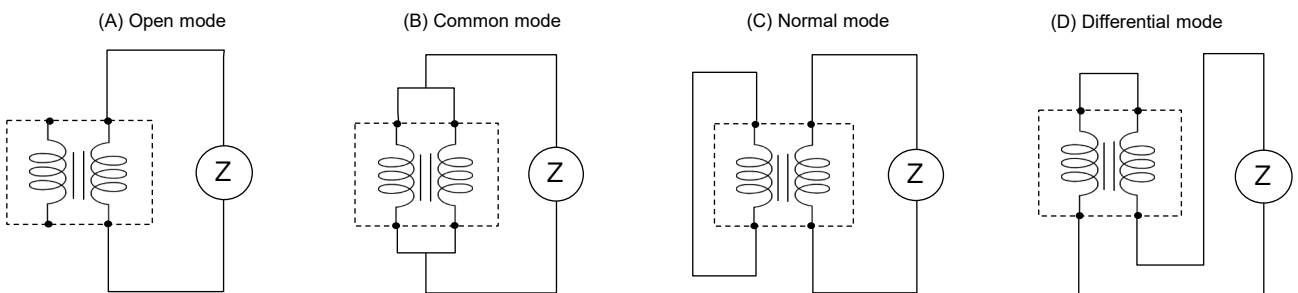

■ As for packaging methods, soldering conditions and safety precautions, please see data files

### Packaging methods (Taping)

● Standard quantity

Part number	Size (inch)	Kind of taping	Pitch (P <sub>1</sub> ) (mm)	Quantity (pcs / reel)
EXC14CP□□□U	0302	Embossed carrier taping	2	10,000
EXC24CP/CB□□□U	0504		4	5,000
EXC24CN□□□X	0504	Pressed carrier taping	2	10,000

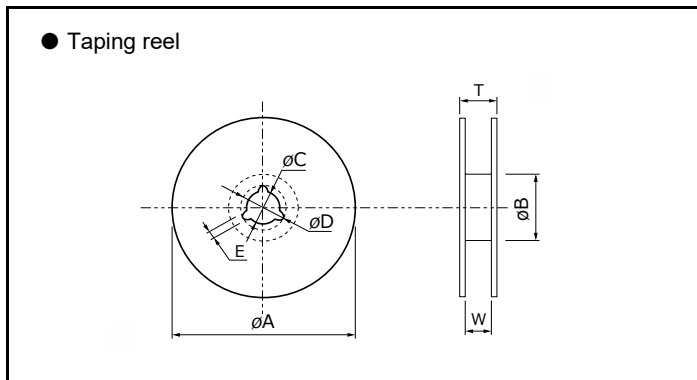
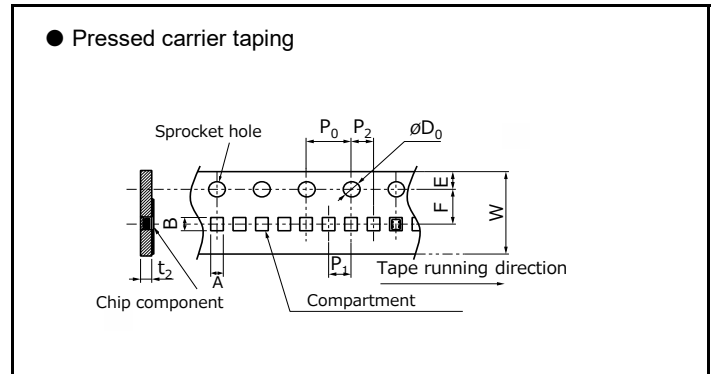
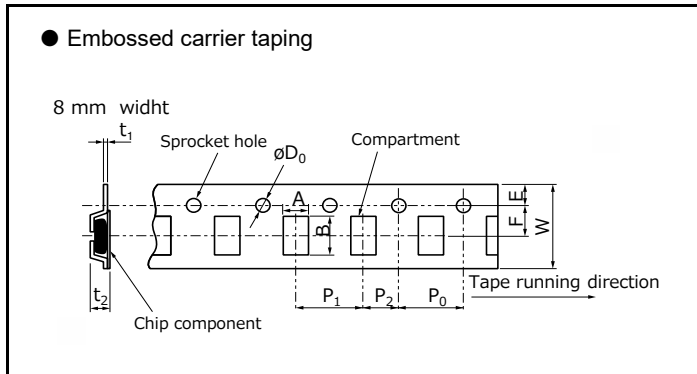

● Embossed carrier dimensions

Unit : mm

Part number	A	B	W	F	E	P <sub>1</sub>	P <sub>2</sub>	P <sub>0</sub>	øD <sub>0</sub>	t <sub>1</sub>	t <sub>2</sub>
EXC14CP	0.75±0.10	0.95±0.10	8.0±0.2	3.50±0.05	1.75±0.10	2.0±0.1	2.0±0.1	4.0±0.1	1.5 <sup>+0.1</sup> <sub>0</sub>	0.25±0.05	0.85±0.15
EXC24CP	1.20±0.15	1.45±0.15	8.0±0.2	3.50±0.10	1.75±0.10	4.0±0.1	2.0±0.1	4.0±0.1	1.5 <sup>+0.1</sup> <sub>0</sub>	0.25±0.05	0.90±0.15
EXC24CB											

● Pressed carrier dimensions

Unit : mm

Part number	A	B	W	F	E	P <sub>1</sub>	P <sub>2</sub>	P <sub>0</sub>	øD <sub>0</sub>	t <sub>2</sub>
EXC24CN	1.14±0.10	1.38±0.15	8.0±0.2	3.5±0.1	1.75±0.10	2.0±0.1	2.0±0.1	4.0±0.1	1.5 <sup>+0.1</sup> <sub>0</sub>	0.68±0.10

● Standard reel dimensions

Unit : mm

Part number	øA	øB	øC	øD	E	W	T
EXC14C	180.0±3.0	60.0±1.0	13.0±0.5	21.0±0.8	2.0±0.5	9.0±0.3	11.4±1.5
EXC24C							

### Recommended land pattern design

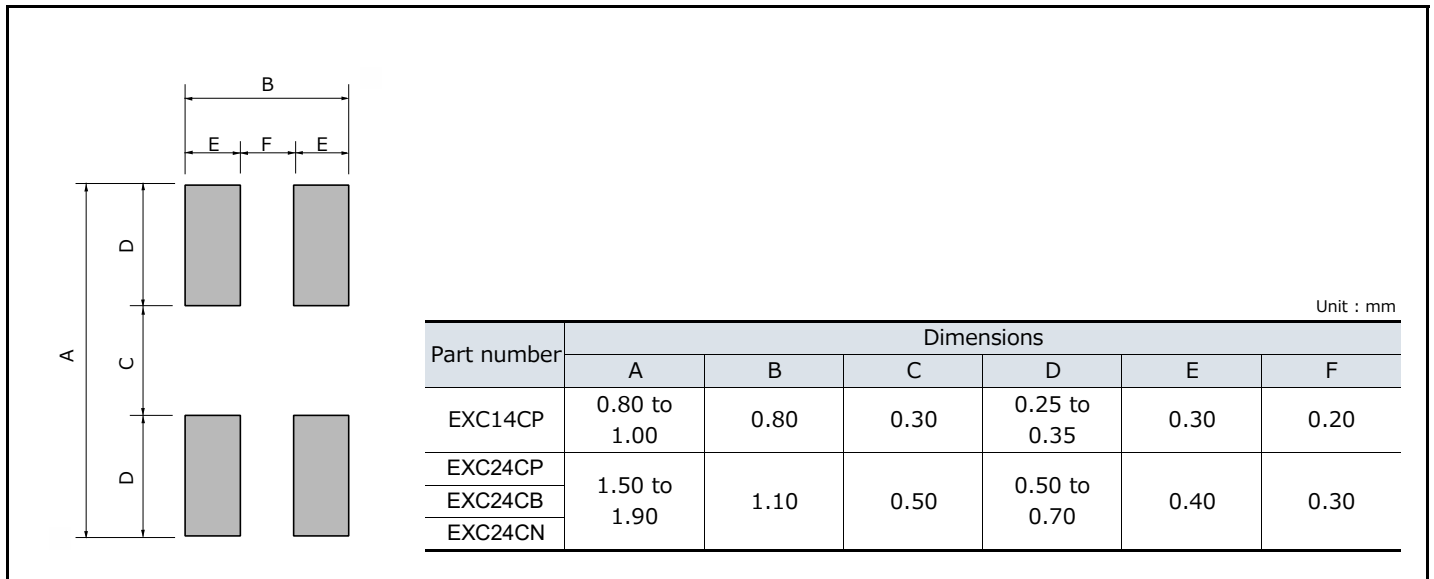

### Recommended soldering conditions

Recommendations and precautions are described below

#### ● Recommended soldering conditions for reflow

- Reflow soldering shall be performed a maximum of two times.
- Please contact us for additional information when used in conditions other than those specified.
- Please measure the temperature of the terminals and study every kind of solder and printed circuit board for solderability before actual use.

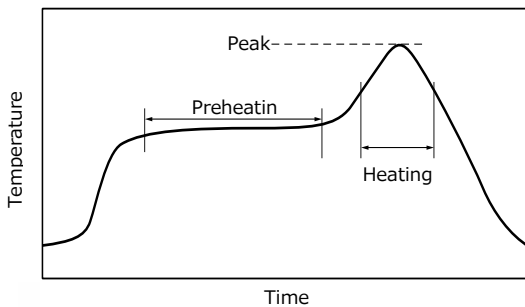

#### ● Flow soldering

- We do not recommend flow soldering, because flow soldering may cause bridges between the electrodes.

For soldering (Example : Sn-37Pb)

	Temperature	Time
Preheating	140 °C to 160 °C	60 s to 120 s
Main heating	Above 200 °C	30 s to 40 s
Peak	235 ± 10 °C	max. 10 s

For lead-free soldering (Example :Sn-3Ag-0.5Cu)

	Temperature	Time
Preheating	150 °C to 170 °C	60 s to 120 s
Main heating	Above 230 °C	30 s to 40 s
Peak	max. 260 °C	max. 10 s

《Repair with hand soldering》

- Preheat with a blast of hot air or similar method. Use a soldering iron with a tip temperature of 350 °C or less. Solder each electrode for 3 seconds or less.
- Never touch this product with the tip of a soldering iron.

## Common Mode Noise Filters / Common performance

Performance		
Test item	Performance requirements	Test conditions resistance
Resistance	Within specified tolerance	25 °C
Overload	—	Rated voltage
Resistance to soldering heat	±30 % (Impedance change)	260 °C, 10 s
Rapid change of temperature	±30 % (Impedance change)	-40 °C (30 min.) / +85 °C (30 min.), 200 cycles
High temperature exposure	±30 % (Impedance change)	85 °C , 500 h
Damp heat, Steady state	±30 % (Impedance change)	60 °C, 95 %RH, 500 h
Load life in humidity	±30 % (Impedance change)	60 °C, 95 %RH, Rated current, 500 h

## Matters to Be Observed When Using This Product (ESD Suppressor)

### Use environments and cleaning conditions

- This product is not designed for use in specific environments. Using this product in the following specific environments or service conditions may affect the performance/reliability of this product. Avoid using it in such specific environments. If you intend to use this product in such environments, checking the performance, reliability, etc., of the product sufficiently is your own responsibility.
  - (1) Used in liquid, such as water, oil, chemicals, and organic solvents.
  - (2) Used in a place exposed to direct sunlight, an outdoor place with no shielding, or a dusty place.
  - (3) Used in a place where the product is heavily exposed to sea breeze or a corrosive gas, such as Cl<sub>2</sub>, H<sub>2</sub>S, NH<sub>3</sub>, SO<sub>2</sub>, or NO<sub>x</sub>.
  - (4) Used in an environment where static electricity and electromagnetic waves are strong.
  - (5) Located close to a heating component or a flammable material, such as a vinyl cable placed near the product.
  - (6) Sealed or coated with a resin.
  - (7) Solder flux of this product soldered with no-clean type solder, etc., is cleansed with a solvent, water, or a water-soluble cleaner, etc. (Water-soluble flux residues have a particularly large influence on this product.)
  - (8) Used in a place where dew concentrates on the product.
  - (9) Used in a contaminated state.  
(Example: Touching this product mounted on a printed circuit board with sebum still attached. (improper handling))
- Sealing this product with a resin in a resin potting process, damp-proofing process, etc., applies excessive stress to this product, which may cause the internal electrodes a connection problem. In such cases, the proper operation of this product is not guaranteed. If you intend to use this product in such environments, checking the performance, reliability, etc., of the product sufficiently is your own responsibility.
- Do not leave this product immersed in a solvent for a long time. When using this product immersed in a solvent, confirm the operation of the product mounted on the board.
- When a cleaning solution or cleaning condition for cleaning the printed board or a drying condition for drying the printed board after soldering this product is improper, it may have a negative effect on the performance/reliability of this product. Confirming these conditions sufficiently is your own responsibility. Also examine the effects of soiled cleaning agent, cleaning residues, and post-cleaning contaminations, and control for these effects properly.

### Response to anomalies and handling conditions

- When this product is heating abnormally or emitting a smell, stop using this product immediately, for example, turn off the main power supply of the device.  
Also, keep your face and hands away from the product as it may become hot and cause burns.
- This product is so thin that it may break easily when subjected to impact. Before putting this product in use, confirm that this product has not been broken by impact that applied thereto when mounted on the printed board. Applying impact to this product or pinching this product with a hard tool (pliers, tweezers, etc.) may chip this product, which affects its performance. Be careful to avoid such cases.
- Do not reuse this product having been used on a printed board and removed therefrom. Do not touch this product with your bare hands.
- Be careful not to drop this product on the floor, etc. This product is likely to suffer mechanical or electrical damage when dropped on the floor. Avoid using said this product.
- It is guaranteed that this product not exposed to any stress will have its proper leakage current value. Any stress or pressure applied to this product may cause its leakage current value to change. Examine and evaluate the characteristics of this product sufficiently before using it.

### Reliability and product life

A product conforming to "AEC-Q200" refers to a product having passed some or all of the evaluation test items defined in AEC-Q200. To know the detailed specifications of individual products or specific evaluation test scores, please contact us. We issue a delivery specification sheet for each product ordered. Please confirm with the sheet when you place an order with us.

## Circuit design and circuit board design

- To prevent a case where an excessively large load the suppressor cannot handle, such as surge larger than the ESD energy, is applied to the suppressor, make sure to evaluate and confirm the operation of the suppressor when the suppressor is incorporated in your product. Applying a voltage larger than the rated voltage to the suppressor may impair its performance and reliability. Make sure to use the product with a voltage equal to or lower than the rated voltage. The product warranty does not cover usage where an excessively large load, such as a surge or pulse current, is applied to the suppressor.
- Be careful that unusual stress caused by an excessive bend of the printed board is not applied to this product. Design the circuit structure such that this product is not close to a perforated line for board splitting or on a line with sizable holes bored on the board.
- When a different component is mounted on the board where this product has been soldered, be careful that the board does not bend excessively. If necessary, provide the board with backup pins (support pins) to keep it straight.
- Avoid manual board splitting. Use a jig, etc., to break the board so that it does not bend excessively when split apart.

## Mounting conditions

- When the product is used under mounting conditions departing from mounting conditions specified in our specification sheet, the product may be exposed to unexpected stress to fail. Be careful to avoid such a case. When mounting the suppressor (except a high tolerance dose ESD suppressor) on a printed board, set the suppressor's front and back surfaces in the direction indicated by the tape. Make sure to evaluate and confirm the operation of the suppressor incorporated in your product and determine whether the suppressor is usable as a component of the product.
- Set soldering conditions for this product within the recommended soldering conditions specified by our company. Any time, soldering condition departing from the specified soldering condition, such as a high peak temperature or a long heating may impair the performance/reliability of this product. Note that the specified soldering conditions indicate conditions under which degradation of this product characteristics does not occur but do not indicate conditions under which stable soldering can be performed. Check and set individual conditions under which stable soldering can be performed.
- Heat this product in advance so that a difference between the soldering temperature and the temperature of this product surface is reduced to 100 °C or lower. When dipping the soldered product in a solvent, etc., to cool this product rapidly, ensure that the temperature difference between this product and the solvent is 100 °C or lower during the dipping.
- When soldering this product using a soldering iron, apply hot air, etc., to this product to heat it sufficiently in advance and then solder this product without bringing the soldering iron tip into contact with the product. If the temperature of the soldering iron tip is high, finish the soldering work quickly (within 3 seconds when the temperature of the soldering iron tip is 350 °C or lower).
- Soldering this product with too much solder or too little solder results in the poor reliability of the solder connection of this product. Use the proper volume of solder in the soldering process. Sufficiently check for the volume of solder used.
- Soldering with high bond strength or special property solder may affect the quality of this product. Do not use such solder.
- Use rosin-based solder flux. When using highly active solder flux made mainly of halogen (chlorine, bromine, etc.), flux residues may affect the performance and reliability of this product. Check the effects of flux residues before using the solder flux. Do not use highly acidic flux, water-soluble flux, or flux containing fluoride ions. When solder flux sticks to this product after the soldering process, the activation energy of the flux may corrode this product and cause it to fail. Prevent solder flux from sticking to this product.

## Storage conditions

Keeping the product in the following environments or conditions may lead to degradation of its performance, solderability, etc. Do not keep the product in the following environments.

- (1) Stored in a place where the product is heavily exposed to sea breeze or a corrosive gas, such as Cl<sub>2</sub>, H<sub>2</sub>S, NH<sub>3</sub>, SO<sub>2</sub>, or NO<sub>x</sub>.
- (2) Stored in a place where the product is exposed to direct sunlight.
- (3) Stored in a place where a temperature condition of 5 °C to 35 °C and a relative humidity condition of 45% to 85% cannot be maintained.
- (4) Kept in storage for more than one year from the delivery date (when the product is kept in conditions excluding any of the environments (1) to (3)).

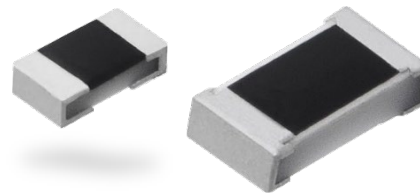

## ESD Suppressor

### EZAEG 2A, 3A type

- Don't use these products in the engine room.
- Don't use these products in any driving applications or any other critical functions that may affect passenger's safety. (e.g. Power train, ABS, Engine ECU, Air bag, and so on.)
- Don't use these products in applications related to the autonomous driving equipment with system level 3 or higher.

### Features

- ESD protection of high-speed data lines
- Low capacitance [1005 (0402) size : 0.05 pF, 1608 (0603) size : 0.10 pF]
- Good ESD suppression characteristics
- Good ESD withstanding
- RoHS compliant

### Recommended applications

- Smart phones, Mobile phones, RF Modules, NFC and GPS
- ESD suppression of high-speed differential data line such as Antena circuit, HDMI, SATA, USB, Display Port

### Explanation of part numbers

1	2	3	4	5	6	7	8	9	10	11
E	Z	A	E	G	2	A	5	0	A	X

  

Product code	Code	Dimensions (mm) (inch)	Code	Design specification	Code	Voltage	Code	Feature	Packing methods		
ESD Suppressor	2	1005 (0402)	A	Rated voltage 30 V	50	500 V	A	Standard	Code	Packaging	Part No.
	3	1608 (0603)							X	Pressed carrier taping 2 mm pitch, 10,000 pcs	EZAEG2A
									V	Punched carrier taping 4 mm pitch, 5,000 pcs	EZAEG3A

### Construction

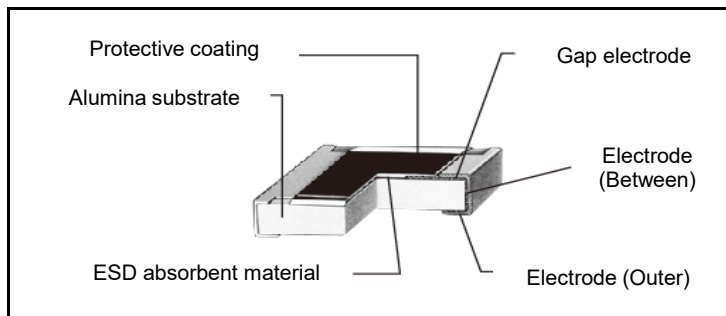

### Circuit configuration

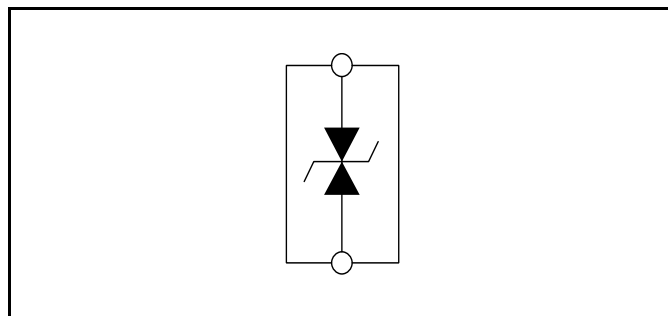

### Dimensions (not to scale)

Part No. (inch size)	Dimensions					Mass (Weight) (g/1000 pcs)
	L	W	a	b	T	
EZAEG2A (0402)	1.00 ± 0.10	0.50 ± 0.05	0.20 ± 0.10	0.25 ± 0.10	0.38 ± 0.05	0.6
EZAEG3A (0603)	1.60 ± 0.15	0.80 ± 0.15	0.30 ± 0.20	0.30 ± 0.20	0.50 ± 0.10	2.2

Unit : mm

**Ratings**

Part number	Capacitance <sup>*1</sup> (pF)	Rated voltage	Category temperature range
EZAEG2A50AX	0.05 <sup>+0.05</sup> / <sub>-0.04</sub>	30 V max.	-55 °C to +125 °C
EZAEG3A50AV	0.10 <sup>+0.10</sup> / <sub>-0.08</sub>		

\*1: Capacitance = The capacitance value shall be measured under the conditions specified below.

Frequency : 1 MHz ± 10 %, Voltage : 1 Vrms ± 0.2 Vrms, Temperature : 25 °C ± 2 °C

**Performance**

Test item	Performance requirements	Test conditions
Peak voltage	500 V max.	IEC61000-4-2, contact discharge 8 kV, Peak voltage value
Clamping voltage	100 V max.	IEC61000-4-2, contact discharge 8 kV, voltage at 30 ns after initiation of pulse
Leakage current	1 µA max.	Current at rated voltage (DC 30 V)
ESD withstanding	Leakage current 10 µA max.	IEC61000-4-2, contact discharge 8 kV, +/- 10 times
Rapid change of temperature		-55 °C (30 min.) / +125 °C (30 min.), 100 cycles
Load life in humidity		60 °C, 90 % to 95 %RH, Rated voltage, 1000 h
Endurance at 85 °C		85 °C, Rated voltage, 1000 h
Resistance to soldering heat		270 °C, 10 s

**Frequency characteristics**

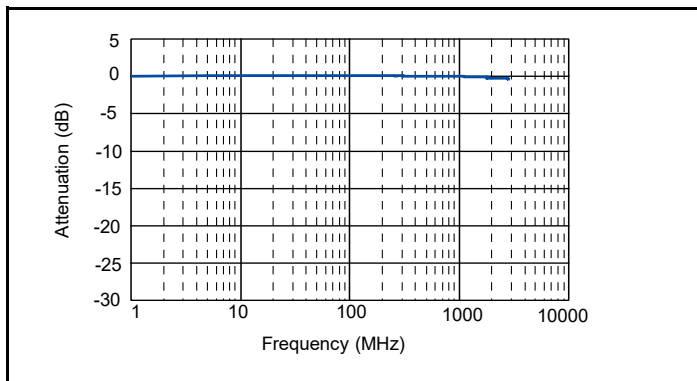

**ESD Suppression voltage waveform**

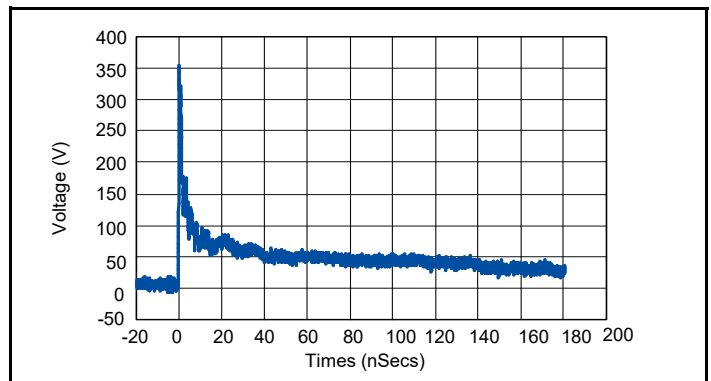

**Typical circuits requiring protection**

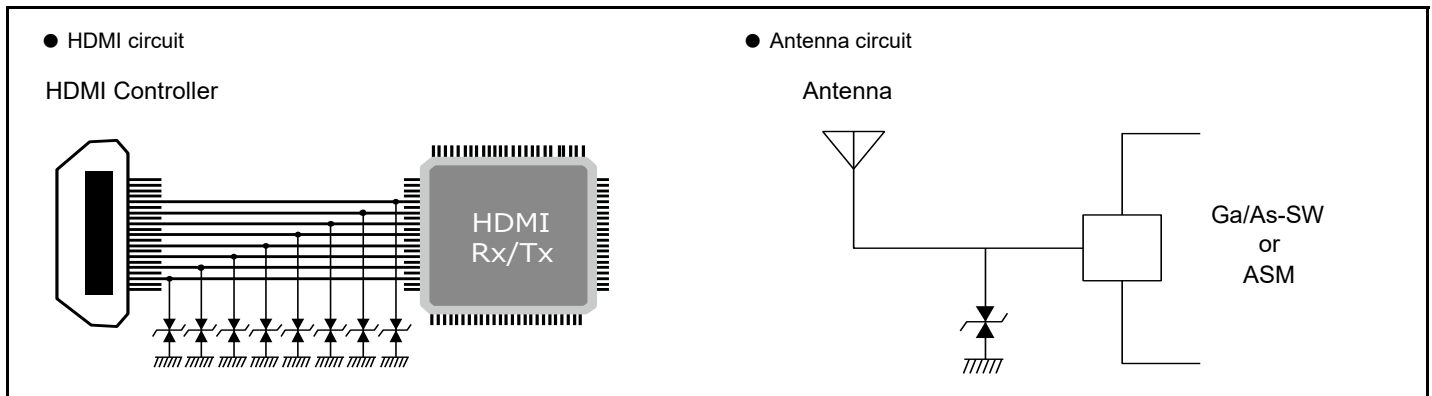

**Recommended land pattern**

Recommended land pattern design for ESD Suppressor is shown below.

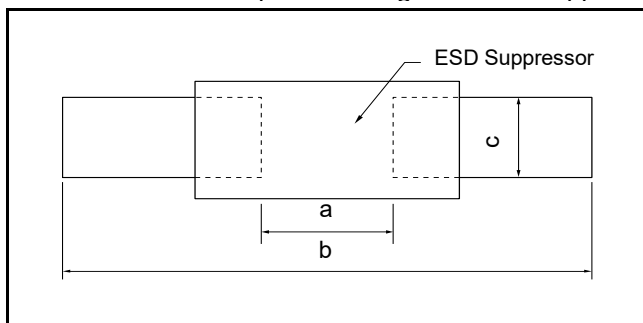

Unit : mm

Part number	Dimensions		
	a	b	c
EZAEG2A	0.5 to 0.6	1.4 to 1.6	0.4 to 0.6
EZAEG3A	0.7 to 0.9	2.0 to 2.2	0.8 to 1.0

■ As for packaging methods, soldering conditions and safety precautions, please see data files.

## ESD Suppressor

### EZAEG 1N, 2N type

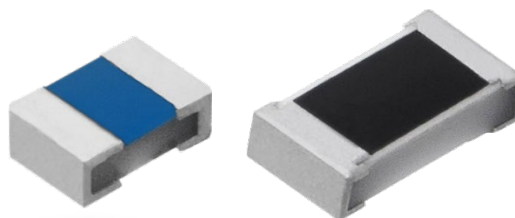

- Don't use these products in the engine room.
- Don't use these products in any driving applications or any other critical functions that may affect passenger's safety. (e.g. Power train, ABS, Engine ECU, Air bag, and so on.)
- Don't use these products in applications related to the autonomous driving equipment with system level 3 or higher.

### Features

- Good ESD withstanding (IEC61000-4-2 15 kV contact/air Discharge)
- ESD protection of high-speed data lines
- Low capacitance [0603 (0201) size : 0.04 pF, 1005(0402) size : 0.05 pF]
- Good ESD suppression characteristics
- RoHS compliant

### Recommended applications

- Smart phones, Mobile phones, RF Modules, NFC and GPS
- ESD suppression of high-speed differential data line such as Antena circuit, HDMI, SATA, USB, Display Port

### Explanation of part numbers

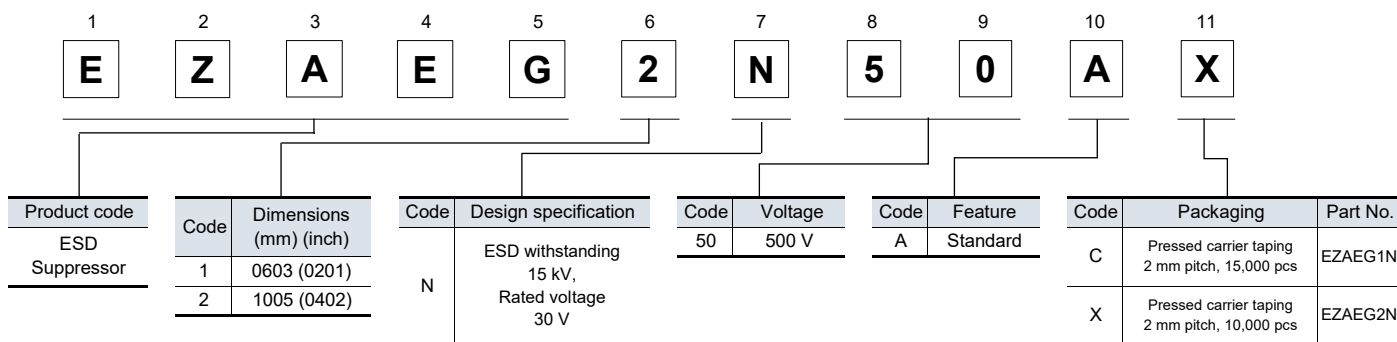

### Construction

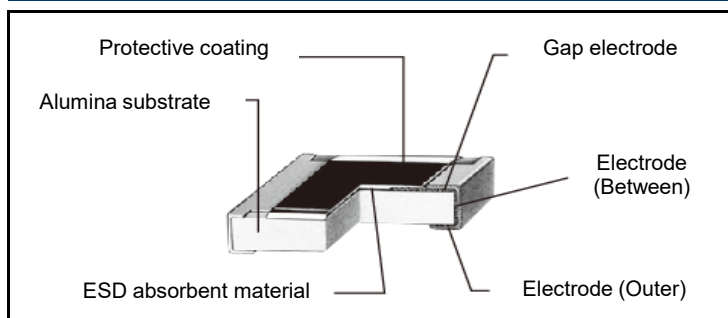

### Circuit configuration

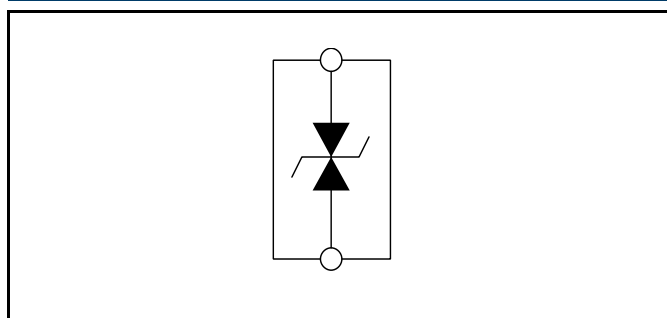

### Dimensions (not to scale)

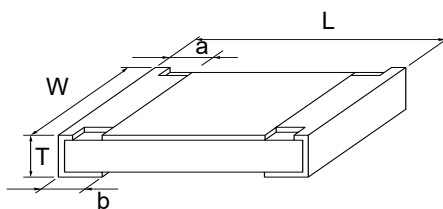

Unit : mm

Part No. (inch size)	Dimensions					Mass (Weight) (g/1000 pcs)
	L	W	a	b	T	
EZAEG1N (0201)	0.60 ± 0.03	0.30 ± 0.03	0.15 ± 0.10	0.15 ± 0.10	0.23 ± 0.03	0.12
EZAEG2N (0402)	1.00 ± 0.10	0.50 ± 0.05	0.20 ± 0.10	0.27 ± 0.10	0.38 ± 0.05	0.60

**Ratings**

Part number	Capacitance *1 (pF)	Rated voltage	Category temperature range
EZAEG1N50AC	0.04 <sup>+0.04</sup> <sub>-0.03</sub>	30 V max.	-55 °C to +125 °C
EZAEG2N50AX	0.05 <sup>+0.05</sup> <sub>-0.04</sub>		

\*1: Capacitance = The capacitance value shall be measured under the conditions specified below.

Frequency : 1 MHz ± 10 %, Voltage : 1 Vrms ± 0.2 Vrms, Temperature : 25 °C ± 2 °C

**Performance**

Test item	Performance requirements	Test conditions
Peak voltage	500 V max.	IEC61000-4-2, contact discharge 8 kV, Peak voltage value
Clamping voltage	100 V max.	IEC61000-4-2, contact discharge 8 kV, voltage at 30 ns after initiation of pulse
Leakage current	1 µA max.	Current at rated voltage (DC 30 V)
ESD withstanding	Leakage current 10 µA max.	IEC61000-4-2, contact discharge 15 kV or air discharge 15 kV, +/- 50 times
Rapid change of temperature		-55 °C (30 min.) / +125 °C (30 min.), 100 cycles
Load life in humidity		60 °C, 90 % to 95 %RH, Rated voltage, 1000 h
Endurance at 85 °C		85 °C, Rated voltage, 1000 h
Resistance to soldering heat		270 °C, 10 s

**Frequency characteristics**

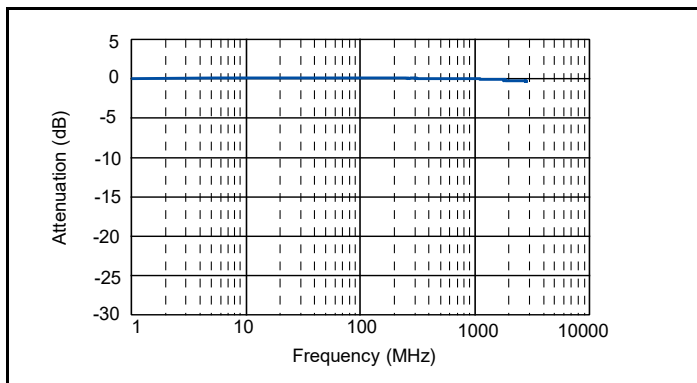

**ESD Suppression voltage waveform**

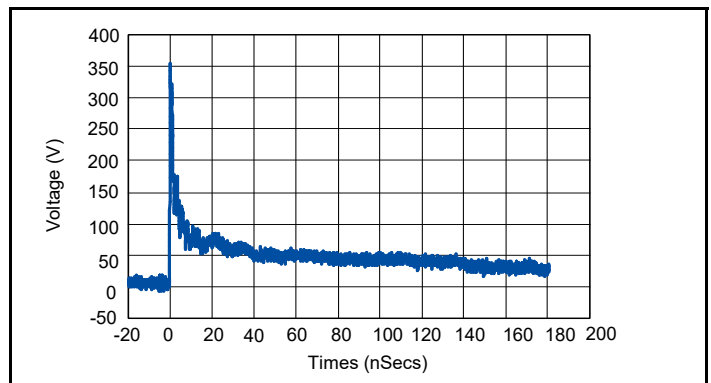

**Typical circuits requiring protection**

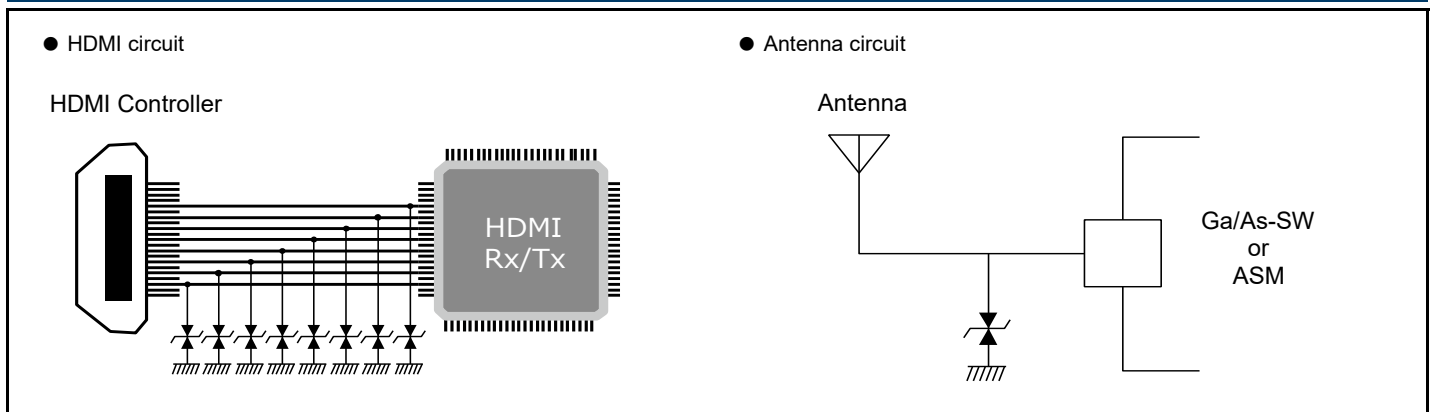

**Recommended land pattern**

Recommended land pattern design for ESD Suppressor is shown below.

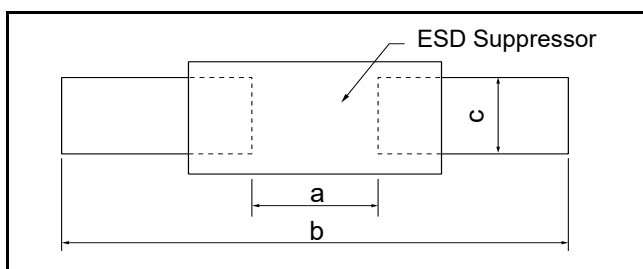

Unit : mm

Part number	Dimensions		
	a	b	c
EZAEG1N	0.3 to 0.4	0.8 to 0.9	0.25 to 0.35
EZAEG2N	0.5 to 0.6	1.4 to 1.6	0.40 to 0.60

■ As for packaging methods, soldering conditions and safety precautions, please see data files.

# ESD Suppressor Array

## EZAEG CA type

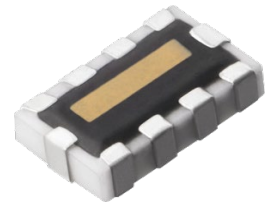

- Don't use these products in the engine room.
- Don't use these products in any driving applications or any other critical functions that may affect passenger's safety. (e.g. Power train, ABS, Engine ECU, Air bag, and so on.)
- Don't use these products in applications related to the autonomous driving equipment with system level 3 or higher.

### Features

- 4 ESD suppressors in one package
- ESD protection of high-speed data lines
- Low capacitance (0.25 pF)
- Good ESD suppression characteristics
- Good ESD withstanding
- RoHS compliant

### Recommended applications

- AV equipment (LCD-TV, DVD/Blu-ray drives), Information equipment (PCs, HDD)
- ESD suppression of high-speed differential data line such as USB3.0, HDMI, Display Port

### Explanation of part numbers

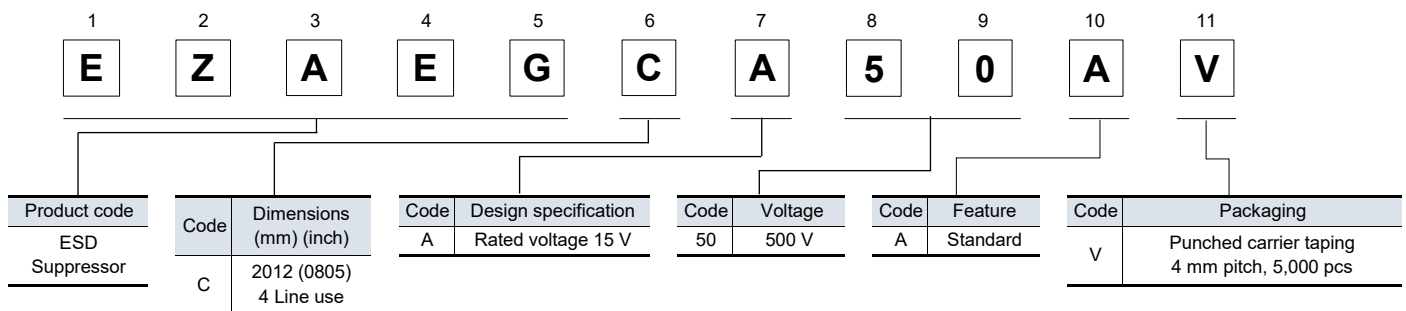

### Construction

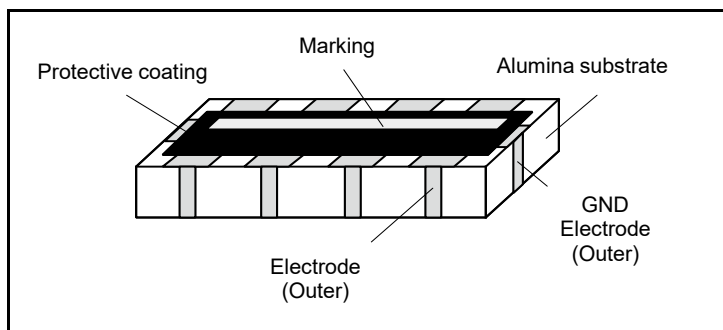

### Circuit configuration

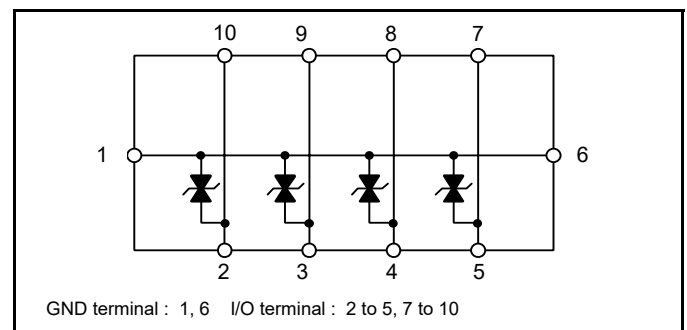

### Dimensions (not to scale)

( ) Reference  
Unit : mm

Part No. (inch size)	Dimensions								Mass (Weight) (g/1000 pcs)
	L	W	a	b	c	d	e	T	
EZAEGCA50AV (0805)	2.0 ± 0.1	1.25 ± 0.10	(0.5)	0.30 ± 0.15	0.25 ± 0.15	0.20 ± 0.15	0.35 ± 0.15	0.50 ± 0.10	4.0

**Ratings**

Part number	Capacitance *1 (pF)	Rated voltage *2	Rated current *3	Category temperature range
EZAEGCA50AV	0.25 <sup>+0.05</sup> / <sub>-0.10</sub>	15 V max.	100 mA max.	-55 °C to +125 °C

\*1: Capacitance = The capacitance value shall be measured under the conditions specified below.

Frequency : 1 MHz ± 10 %, Voltage : 1 Vrms ± 0.2 Vrms, Temperature : 25 °C ± 2 °C

\*2: Rated voltage between I/O terminal and GND.

\*3: Rated current between input terminal and output terminal.

**Performance**

Test item	Performance requirements	Test conditions
Peak voltage	500 V max.	IEC61000-4-2, contact discharge 8 kV, Peak voltage value
Clamping voltage	100 V max.	IEC61000-4-2, contact discharge 8 kV, voltage at 30 ns after initiation of pulse
Leakage current	1 µA max.	Current at Rated voltage (DC 15 V)
ESD withstanding	Leakage current 10 µA max.	IEC61000-4-2, contact discharge 8 kV, +/- 10 times
Rapid change of temperature		-55 °C (30 min.) / +125 °C (30 min.), 100 cycles
Load life in humidity		60 °C, 90 % to 95 %RH, Rated voltage, 1000 h
Endurance at 85 °C		85 °C, Rated voltage, 1000 h
Resistance to soldering heat		270 °C, 10 s

**Typical circuits requiring protection**

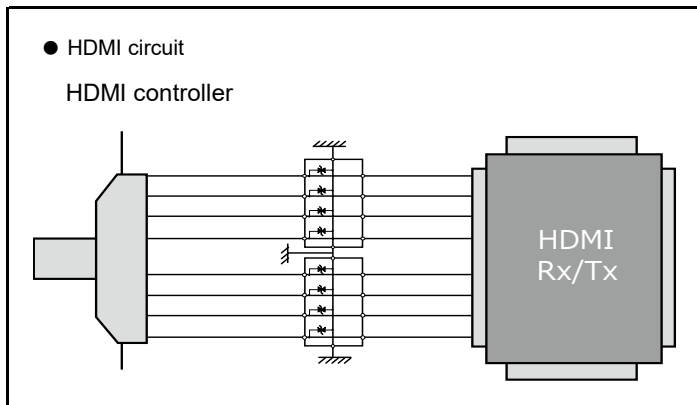

**ESD Suppression voltage waveform**

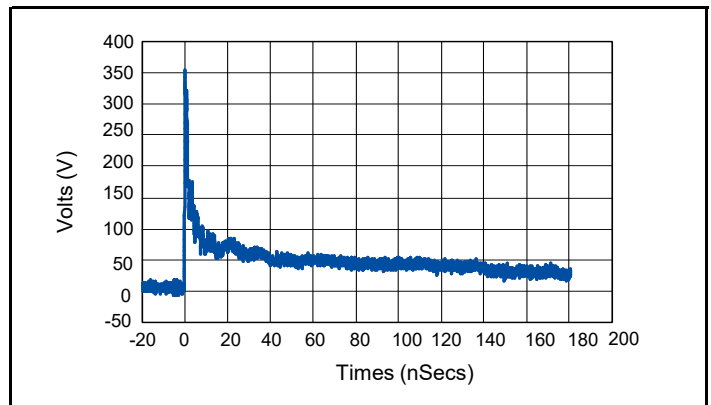

**Recommended land pattern**

Recommended land pattern design for ESD Suppressor Array is shown below.

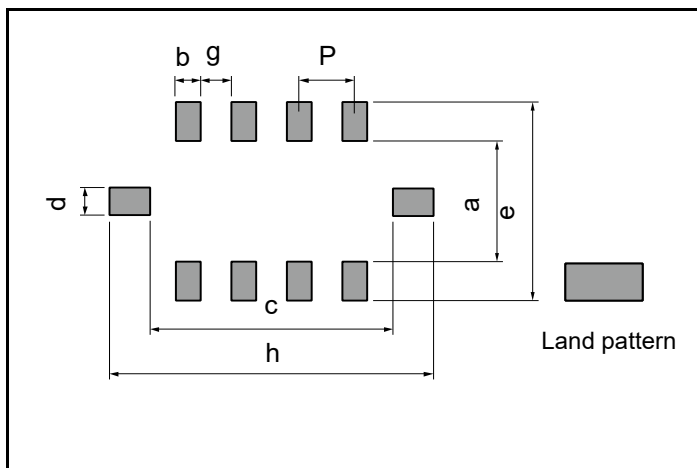

Unit : mm

Dimensions			
a	b	c	d
0.75	0.25	1.70	0.35

Dimensions			
e	h	g	P
1.85	2.60	0.25	0.50

■ As for packaging methods, soldering conditions and safety precautions, please see data files.



## ESD Suppressor / High withstanding products

### EZAEG 3W type

#### Features

- Excellent ESD withstanding(Conforms with automotive ESD standards (ISO10605, air discharge 25 kV)
- Low capacitance 1608 (0603) size : 0.10 pF
- High rated voltage (DC 50 V) contributes to reduce the risk of communication error
- AEC-Q200 compliant
- RoHS compliant

#### Recommended applications

- High speed data line for automotive (CAN, Ethernet, USB, LVDS)
- Automotive antenna
- Amusement equipment

#### Explanation of part numbers

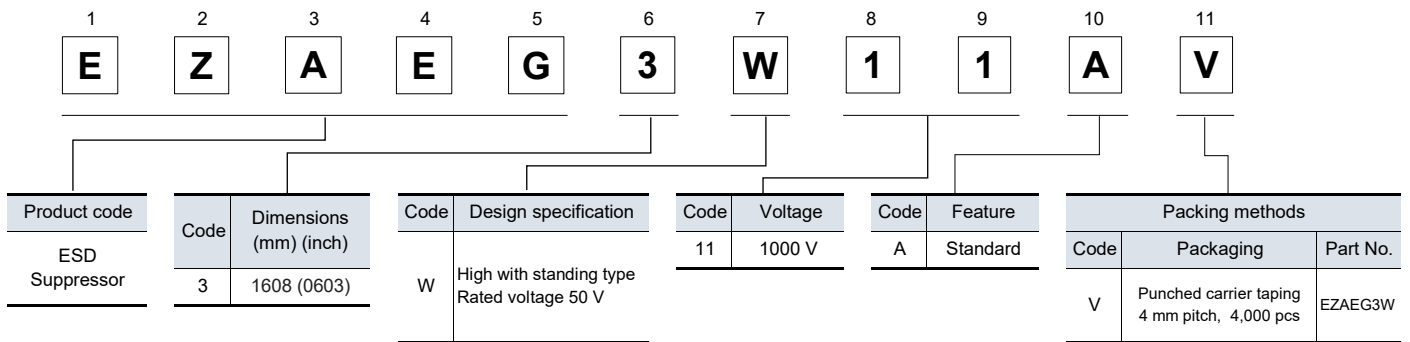

#### Construction

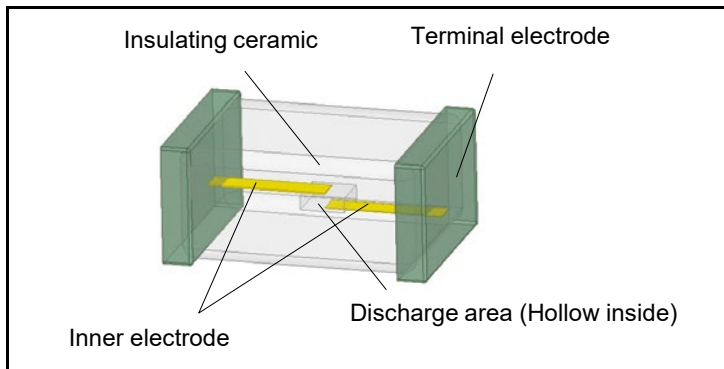

#### Circuit configuration

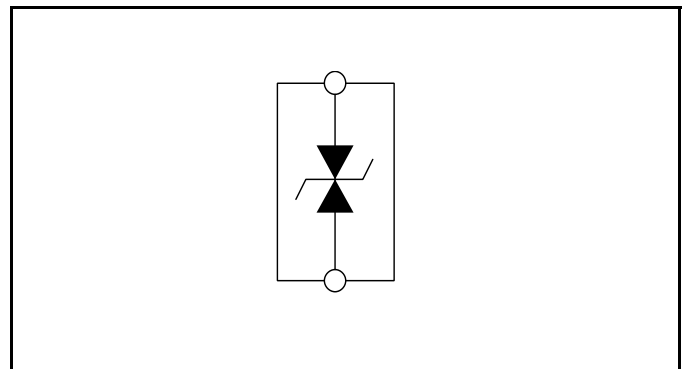

#### Dimensions (not to scale)

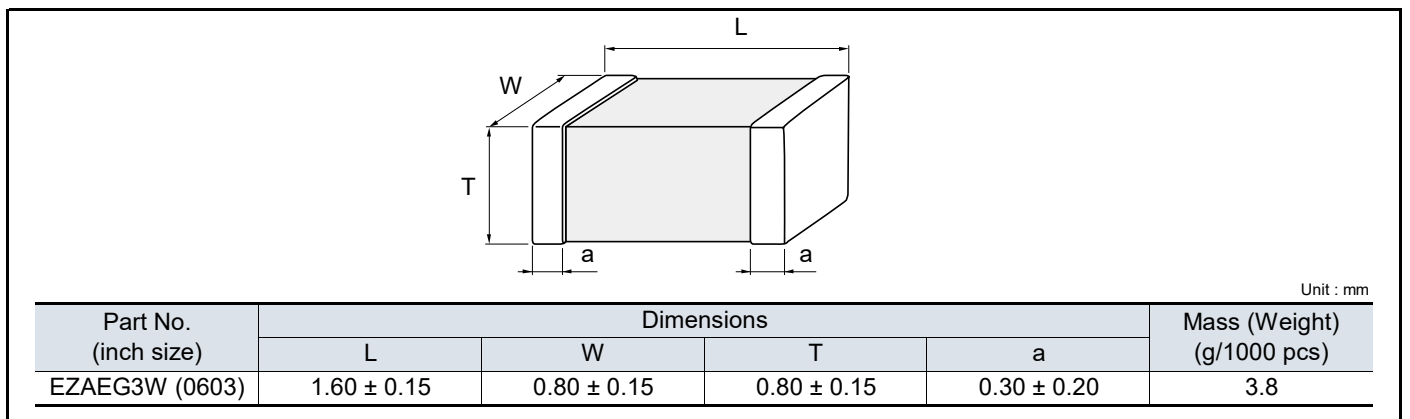

## Ratings

Part number	Capacitance*1 (pF)	Rated voltage	Category temperature range
EZAEG3W11AV	0.10 $\begin{smallmatrix} +0.10 \\ -0.08 \end{smallmatrix}$	50 V max.	-55 °C to +125 °C

\*1: Capacitance = The capacitance value shall be measured under the conditions specified below.

Frequency : 1 MHz  $\pm$  10 %, Voltage : 1 Vrms  $\pm$  0.2 Vrms, Temperature : 25 °C  $\pm$  2 °C

## Performance

Test item	Performance requirements	Test conditions
Peak voltage	1000 V max.	ISO10605, air discharge 15 kV, Peak voltage value
Leakage current	1 $\mu$ A max.	Current at Rated voltage (DC 50 V)
ESD withstanding	Leakage current 10 $\mu$ A max.	ISO10605, air discharge 25 kV, +/- 50 times
Rapid change of temperature		-55 °C (30 min.) / +125 °C (30 min.), 100 cycles
Load life in humidity		85 °C, 85 %RH, Rated voltage, 1000 h
Endurance at 125 °C		125 °C, Rated voltage, 1000 h
Resistance to soldering Heat		270 °C, 10 s

## Frequency characteristics

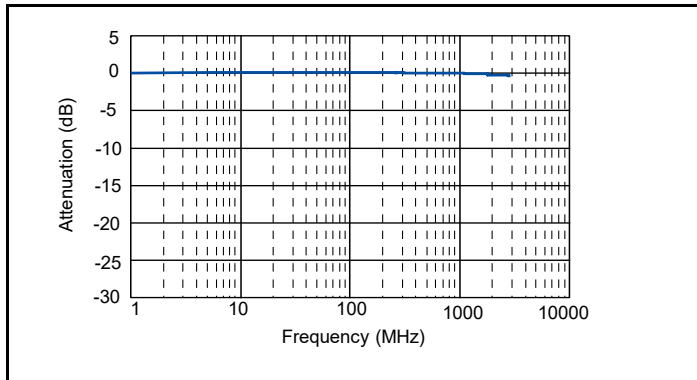

## ESD Suppression voltage waveform

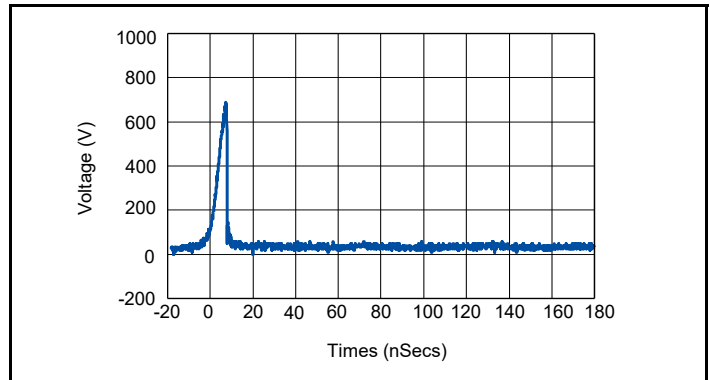

## Typical circuits requiring protection

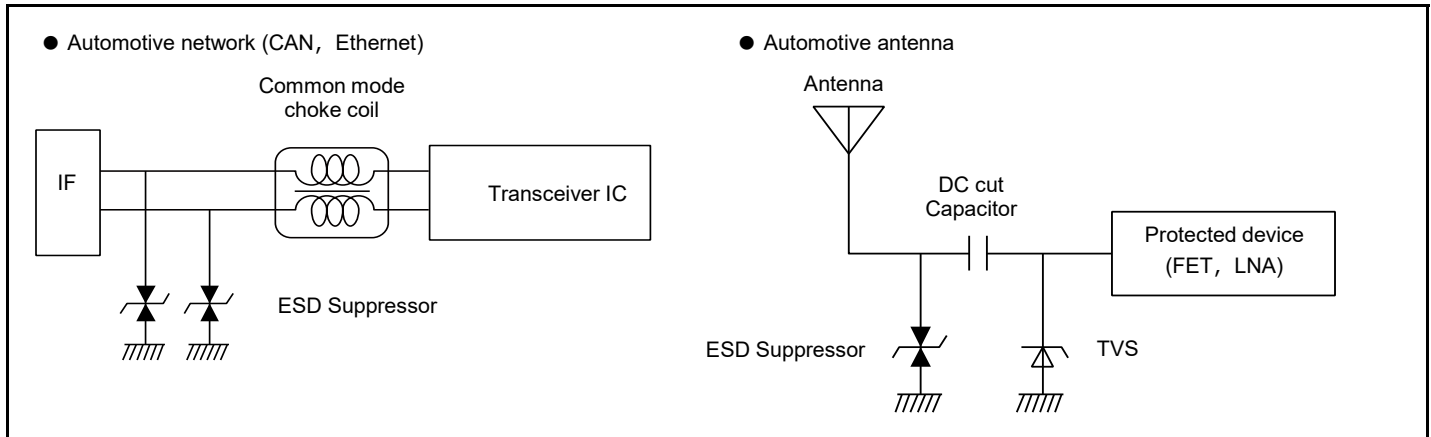

## Recommended land pattern

Recommended land pattern design for ESD Suppressor is shown below.

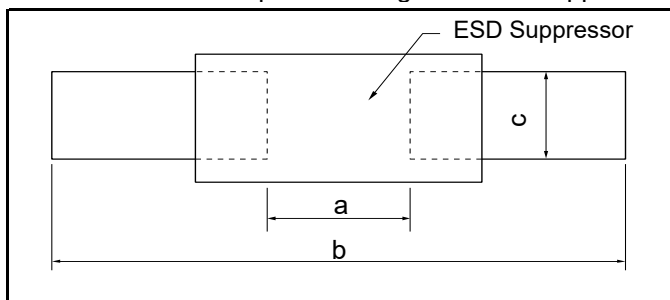

Part number	Dimensions		
	a	b	c
EZAEG3W	0.8 to 1.0	2.0 to 2.6	0.8 to 1.0

Unit : mm

■ As for packaging methods, soldering conditions and safety precautions, please see data files.

## Packaging methods (Taping)

### ● Standard quantity

Part number	Size (inch)	Type	Kind of taping	Pitch (P <sub>1</sub> ) (mm)	Quantity (pcs / reel)
EZAEG1N	0201	Single	Pressed carrier taping	2	15000
EZAEG2A,2N	0402				10000
EZAEG3A	0603		Array	Punched carrier taping	4
EZAEG3W	0603	4000			
EZAEGCA	0805	5000			

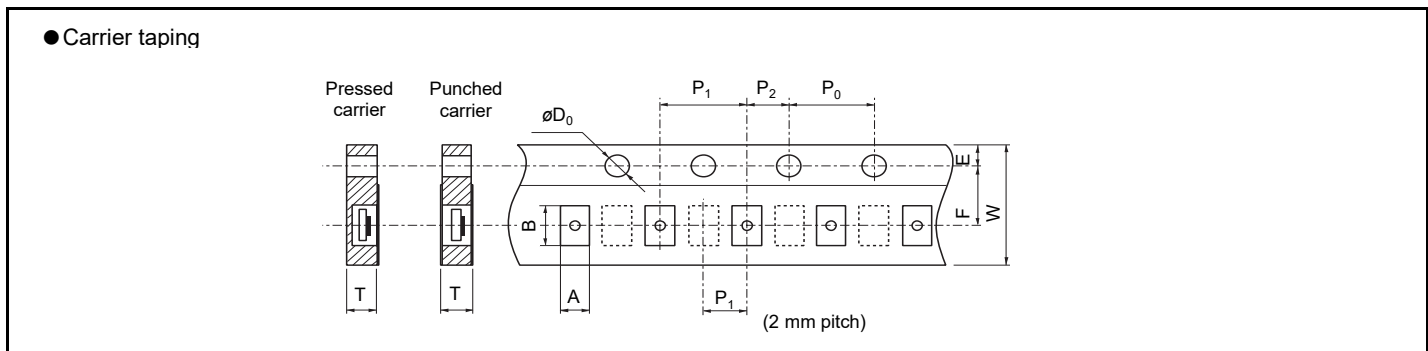

Unit : mm

Part number	Size(inch)	A	B	W	F	E	P <sub>1</sub>	P <sub>2</sub>	P <sub>0</sub>	øD <sub>0</sub>	T
EZAEG1N	0201	0.38±0.05	0.68±0.05	8.00±0.20	3.50±0.05	1.75±0.10	2.00±0.10			1.5 <sup>+0.1</sup> <sub>0</sub>	0.42±0.05
EZAEG2A,2N	0402	0.70±0.05	1.20±0.05								0.60±0.05
EZAEG3A	0603	1.10±0.10	1.90±0.10				0.70±0.05				
EZAEG3W	0603	0.91±0.10	1.82±0.10				4.00±0.10	2.00±0.05	4.00±0.10		1.08±0.10
EZAEGCA	0805	1.55±0.15	2.30±0.20								0.85±0.05

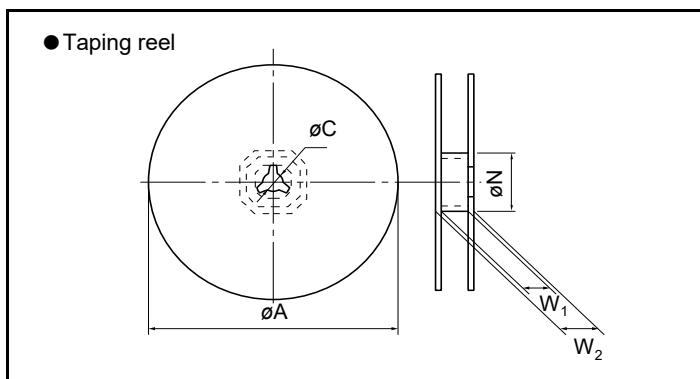

Dimensions		
øA	øN	øC
180.0 <sup>0</sup> <sub>-1.5</sub>	60.0 <sup>+1.0</sup> <sub>0</sub>	13.0±0.2

Dimensions	
W <sub>1</sub>	W <sub>2</sub>
9.0 <sup>+1.0</sup> <sub>0</sub>	11.4±1.0

Unit : mm

## Recommended soldering conditions

Recommendations and precautions are described below

### ● Recommended soldering conditions for reflow

- Reflow soldering shall be performed a maximum of two times.
- Please contact us for additional information when used in conditions other than those specified.
- Please measure the temperature of the terminals and study every kind of solder and printed circuit board for solderability before actual use.

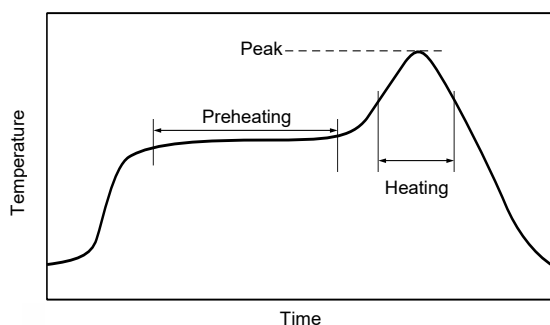

For soldering (Example : Sn/Pb )

	Temperature	Time
Preheating	140 °C to 160 °C	60 s to 120 s
Main heating	Above 200 °C	30 s to 40 s
Peak	235 ± 5 °C	max. 10 s

For lead-free soldering (Example : Sn/Ag/Cu )

	Temperature	Time
Preheating	150 °C to 180 °C	60 s to 120 s
Main heating	Above 230 °C	30 s to 40 s
Peak	max. 260 °C	max. 10 s

## Matters to Be Observed When Using This Product

(Chip-type laminated varistor : Automotive grade)

### Safety measures

- An in-vehicle chip-type laminated varistor (hereinafter “the product” or “the varistor”) is intended for use in general-purpose and standard applications, such as electrostatic control/noise suppression in in-vehicle equipment. The varistor may deteriorate in performance or fail (short or open mode) when used improperly.
- If the varistor in short mode is used, applied voltage may cause a large current to flow through the varistor. Consequently, the varistor heats up and may burn the circuit board. An abnormal state of the varistor that results from a problem with its service conditions (use environment, design conditions, mounting conditions, etc.) may lead to, in a worst case scenario, burnout of the circuit board, serious accident, etc. Sufficiently check for what is described below before using the varistor.

### Use environments and cleaning conditions

- This product (varistor) is not designed for use in the specific environments described below. Using the product in such specific environments or service conditions, therefore, may affect the performance of the product. Please check the performance and reliability of the product first and then use the product.
  - (1) Used in liquid, such as water, oil, chemicals, and organic solvents.
  - (2) Used in a place exposed to direct sunlight, an outdoor place with no shielding, or a dusty place.
  - (3) Used in a place where the product is heavily exposed to sea breeze or a corrosive gas, such as Cl<sub>2</sub>, H<sub>2</sub>S, NH<sub>3</sub>, SO<sub>2</sub>, or NO<sub>x</sub>.
  - (4) Used in an environment where electromagnetic waves and radiation are strong.
  - (5) Located close to a heating component or a flammable material, such as a vinyl cable.
  - (6) Sealed or coated with a resin, etc.
  - (7) Solder flux of the soldered product is cleansed with a solvent, water, and a water-soluble cleaner (be careful with solder flux soluble to water).
  - (8) Used in a place where dew concentrates on the product.
  - (9) Used in a contaminated state. (Example) Touching a varistor (with uncovered skin) mounted on a printed board leaves sebum on the varistor. Do not handle the varistor in this manner.
  - (10) Used in a place where excessive vibration or impact is applied to the product.
- Use the varistor within the range of its specified ratings/capabilities. Using the varistor under severe service conditions that are beyond the specified ratings/capabilities causes degraded performance or destruction of the varistor, which may lead to scattering of varistor fragments, smoke generation, ignition, etc. Do not use the varistor at a working temperature or maximum allowable circuit voltage that exceeds the specified working temperature or maximum allowable circuit voltage. Do not locate the varistor close to combustible materials.
- In an improper cleaning solution, with which the varistor is cleaned, flux residues or other foreign matter may stick to the surface of the varistor, which degrades the performance (insulation resistance, etc.) of the varistor. In a polluted cleaning solution, the concentration of free halogen, etc., is high, and may result in poor/insufficient cleaning.
- Improper cleaning conditions (insufficient cleaning or excessive cleaning) may impair the performance of the varistor.
  - (1) Insufficient cleaning
    - (a) A halogenous substance in flux residues may corrode a metal element, such as a terminal electrode.
    - (b) A halogenous substance in flux residues may stick to the surface of the varistor and lower its insulation resistance.
    - (c) Tendencies described in (a) and (b) may be more notable with water-soluble flux than with rosin-based flux.Be careful about insufficient cleaning.
  - (2) Excessive cleaning

Ultrasonic waves that are too powerful from an ultrasonic cleaner cause the board to resonate, in which case the vibration of the board may cause the varistor or a soldered part to crack or reduce the strength of the terminal electrode. Keep power output from the ultrasonic cleaner at 20 W/L or lower, its ultrasonic frequency at 40 kHz or lower, and an ultrasonic cleaning time at 5 minutes or less.

## Response to anomalies and handling conditions

- Do not apply excessive mechanical impact to the varistor. Because the varistor body is made of ceramic, drop impact to the varistor readily damages or cracks the varistor. Once dropped on the floor, etc., the varistor may have lost its sound quality and become failure-prone. Do not use said varistor.
- When handling the board carrying the varistor, be careful not to let the varistor hit against another board. Take extra caution when handling or storing a stack of boards carrying varistors. There are cases where a corner of a board will hit against a varistor and damage or crack it, which may result in a failure of the varistor, such as a drop in its insulation resistance. Do not reuse a varistor that has been used on and removed from a board.

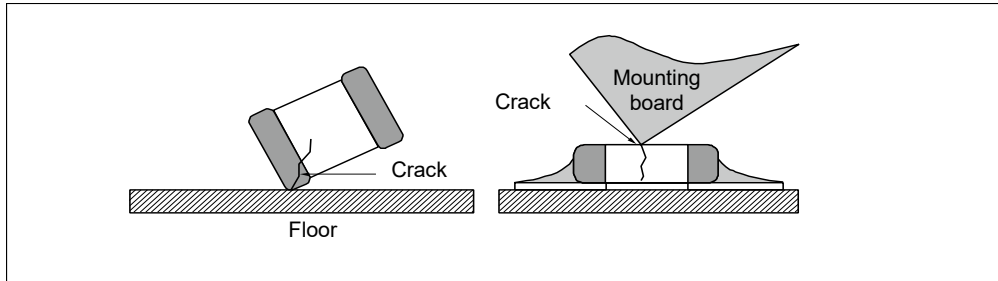

## Reliability

To know the detailed specifications of individual products or specific evaluation test scores, please contact us. We issue a delivery specification sheet for each product ordered. Please confirm with the sheet when you place an order with us.

## Circuit design and circuit board design

- A working temperature at which a varistor works in the circuit must be within the working temperature range specified in the specification sheet. A temperature at which a varistor incorporated in the circuit is kept in storage without operating must be within the storage temperature range specified in the specification sheet. Do not use the varistor at a higher temperature than the maximum working temperature.
- Keep voltage applied across the terminals of the varistor equal to or lower than the maximum allowable circuit voltage. Applying improper voltage to the terminals may cause the varistor to fail or short-circuit thus generate heat. When using the varistor in a circuit where high-frequency voltage or pulse voltage of an acute waveform is applied consecutively, even if the applied voltage is lower than the rated voltage, confirm that the varistor is reliable enough to operate normally in the circuit.
- Ensure that the surface temperature of the varistor, which includes a temperature increment resulting from self-heating, is equal to or lower than the highest working temperature specified in the delivery specification sheet. Check the temperature of the varistor under the circuit conditions used in the operation state of the device in which the varistor is incorporated.
- Using the varistor on an alumina board has an expectation of performance degradation due to thermal impact (temperature cycle). Before using the varistor, sufficiently confirm that the board does not affect the quality of the varistor.

## Mounting conditions

- The more solder deposited on the varistor, the greater the stress to the varistor, which leads to cracking of the varistor. When designing a land on the board, determine the shape and dimensions of the land so that a proper volume of solder is applied in the land. Design the land such that its left and right sides are equal in size. In a case where solder volumes are different between the left and right sides of the land, a greater volume of solder takes more time to cool and solidify. As a result, stress acts on one side which may crack the varistor.

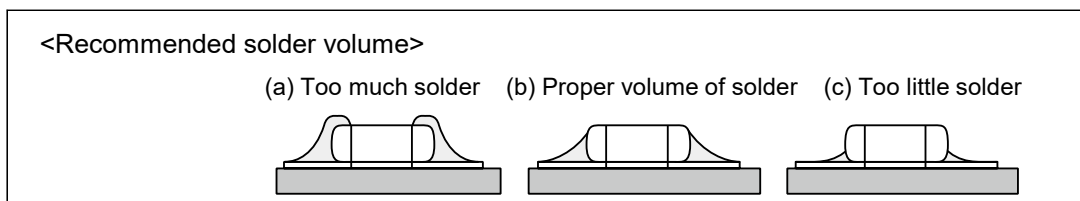

<Recommended land dimensions (example)>

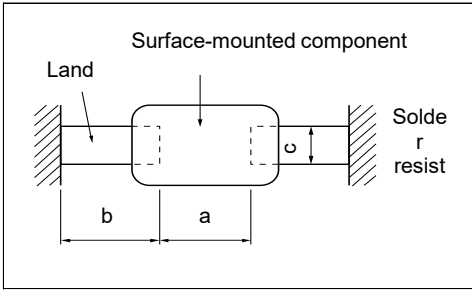

Shape symbol (Inch size)	Component dimensions			a	b	c
	L	W	T			
0 (0402)	1.0	0.5	0.5	0.4 to 0.5	0.4 to 0.5	0.4 to 0.5
1 (0608)	1.6	0.8	0.8	0.8 to 1.0	0.6 to 0.8	0.6 to 0.8
2 (0805)	2.0	1.25	1.25	0.8 to 1.2	0.6 to 1.0	0.6 to 1.0

Unit: mm

[EZJPR-M 2in1 type]

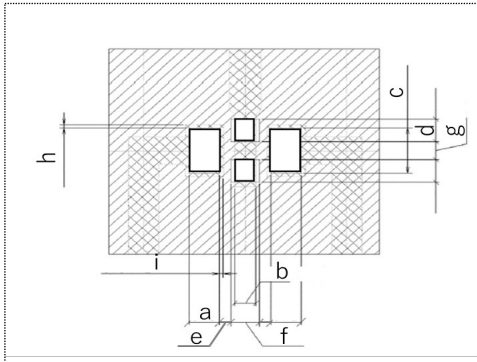

Shape symbol (Inch size)	Component dimensions			a	b	c
	L	W	T			
1 (0603)	1.6	0.8	0.7 max.	0.57 to 0.63	0.37 to 0.43	0.97 to 1.03
	d	e	f	g	h	i
	0.47 to 0.53	0.195 to 0.255	0.52 to 0.58	0.37 to 0.43	(0.075)	(0.075)

Unit: mm

Solder resist (example)

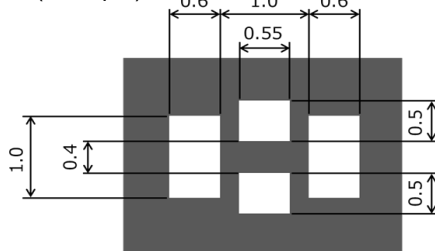

Copper foil (example)

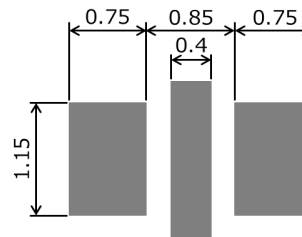

Unit: mm

<Using solder resist>

- Use solder resist to evenly distribute solder volumes on the left and right sides.
- When a component is located close to the varistor, the varistor is mounted together with a lead-attached component, or a chassis is located close to the varistor, separate solder patterns from each other using the solder resist.

\* Refer to cases to avoid and recommended examples shown on the right table.

Items	Case to avoid	Case recommended
		(Example of improving soldering by separating solder patterns)
Mounting the varistor together with a lead-attached component	Lead of a lead-attached component 	Solder resist 
Soldering in the vicinity of the chassis	Chassis Solder (earth solder) Electrode pattern 	Solder resist 
Soldering a lead-attached component later	Lead of a component mounted later Solder iron 	Solder resist 
Placing the products side by side	Part where too much solder is applied Land 	Solder resist 

<Varistor placement that avoids stress caused by warp in the board>

- When the board warps during or after soldering of the varistor to the board, the warping of the board may cause the varistor to crack. Place the varistor so that stress caused by the warp is negligible to the varistor.

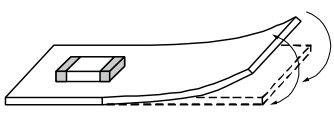
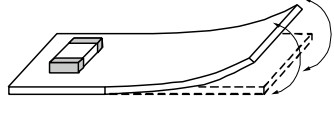
Case to avoid	Case recommended
	 Set the varistor sideways relative to the direction in which stress acts.

\* Refer to the case to avoid and a case recommended example shown on the right table.

<Mechanical stress near a breaking line of the board>

- Mechanical stresses to the varistor near a breaking line of the board vary depending on the mounting position of the varistor. Refer to the figure on the right.
- The varistor receives mechanical stresses different in size when the board is broken by different methods. The size of the stress the varistor receives is smaller in the following order: pushing back<breaking along a slit<breaking along a V groove<breaking along a perforated line. In addition to varistor placement, consider the board breaking method as well.

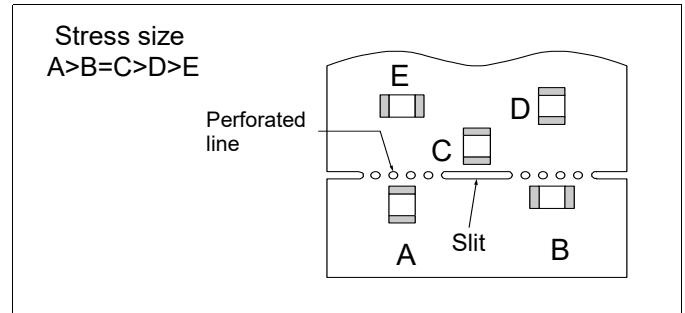

<Mounting density and space between components>

- When space between components is too narrow, solder bridges or solder balls have negative effects on the components. Be careful to provide proper space between the components.

<Mounting on the board>

- When the varistor is mounted on the board, an excessive impact load, such as pressure from a suction nozzle for mounting the varistor and mechanical impact/stress caused by a positional shift or positioning, may be applied to the varistor. Prevent application of such an excessive impact load to the varistor.
- A moulder needs to be checked and maintained regularly.
- When the bottom dead center of the suction nozzle is too low, an excessively large force is applied to the varistor when it is mounted, which may crack the varistor. Heed the following instructions when using the suction nozzle.
  - Set the bottom dead center of the suction nozzle at the upper surface of the straightened board.
  - Set the pressure of the suction nozzle equal to a static load between 1 N to 3 N.
  - In the case of double-face mounting, put a backup pin on the lower surface (back) of the board to prevent the board from warping. This keeps the impact of the suction nozzle as small as possible. Typical examples of using the backup pin are shown in the following table.

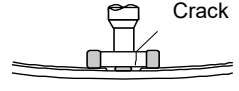
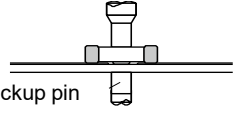
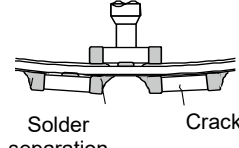
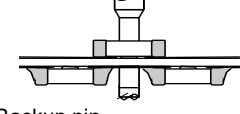
Items	Case to avoid	Case recommended
Single-face mounting	 Crack	The backup pin does not always need to be underneath the varistor.  Backup pin
Double-face mounting	 Solder separation Crack	 Backup pin

(4) Adjust the suction nozzle so that its bottom dead center is not too low.

- When positioning grippers wear out, they apply mechanical impact to part of the varistor when positioning it, thus chipping or cracking the varistor in some cases. Maintain the proper dimensions of the positioning grippers in their closed state and regularly carry out maintenance, check, or replacement of the positioning grippers.
- A varistor mounted on a heavily warped printed board, may crack or break. Put a backup pin on the back of the board to reduce the warp of the board to 0.5 mm or less with 90 mm span width.

<Selecting flux>

- Flux may have a great effect on the performance of the varistor. Before using the varistor, check whether the flux has any effect on the performance of the varistor.

<Soldering>

- Flow soldering (Except EZJPR-M 2in1 type)

In the flow soldering process, stress created by a sharp temperature change is applied directly to the varistor. Be careful, particularly, in controlling the solder temperature. The varistor is particularly vulnerable to rapid heating and rapid cooling. When heated or cooled rapidly, the varistor develops excessive heat stress therein resulting from the large temperature difference and because of this heat stress, may thermally crack. Observe the following instructions on preheating, gradual cooling, etc.

- (1) Applying flux : Apply a thin and uniform film of flux to the varistor. In the flow soldering process, flux application by a foaming method is generally adopted.
- (2) Preheating : Preheat the varistor sufficiently so that the difference between the solder temperature and the surface temperature of the varistor is 150 °C or less.
- (3) Immersion in solder : Immerse the varistor in melted solder of 240 °C to 260 °C in a solder bath for 3 to 5 seconds.
- (4) Gradual cooling : Avoid rapidly cooling (forced cooling) the soldered varistor, instead cool it gradually. Rapidly cooling the varistor may result in thermal cracking of the varistor.
- (5) Cleaning : When dipping the varistor in a cleaning solution right after soldering the varistor, confirm that the surface temperature of the varistor is 100 °C or lower.
- (6) There is no problem with one cycle of flow soldering under the recommended flow soldering profile (example) conditions shown in the following diagram.

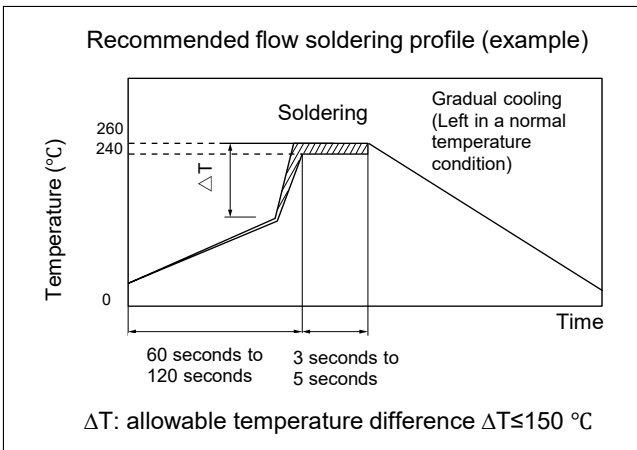

Size	Allowable temperature difference
0402, 0603, 0805	$\Delta T \leq 150 \text{ }^\circ\text{C}$

\* Avoid flow soldering varistors whose specifications are defined separately.

- Reflow soldering

A temperature condition under which reflow soldering is performed is represented by a temperature curve consisting of a preheating part, a temperature-rising part, a main heating part, and a gradual cooling part. Heating the varistor rapidly creates excessive heat stress therein due to a large temperature difference and, because of this heat stress, the varistor may thermally crack. Be sufficiently careful with a temperature difference resulting from rapid heating. The preheating part is a temperature area that is important for preventing a tombstone (chip rising) phenomenon. Be sufficiently careful with temperature control.

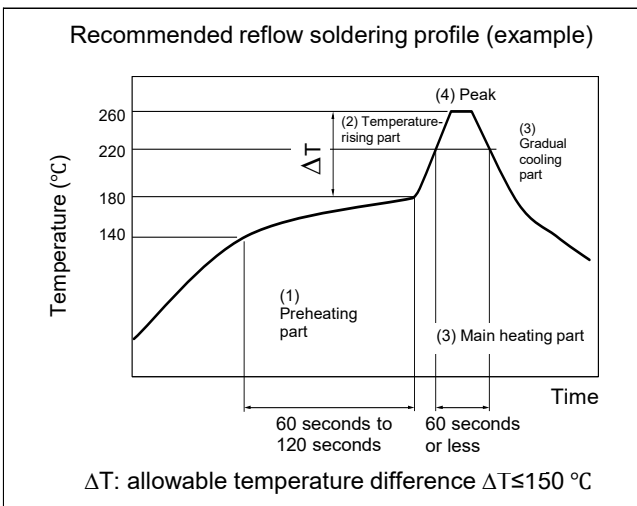

\*Except EZJPR-M 2in1 type

Items	Temperature condition	Time, heating rate
(1) Preheating part	140 °C to 180 °C	60 to 120 seconds
(2) Temperature-rising part	Preheating temperature to peak temperature	2 to 5 °C per second
(3) Main heating part	220 or higher	60 seconds or less
(4) Peak	260 or less	10 seconds or less
(5) Gradual cooling part	Peak temperature to 140 °C	1 to 4 °C per second

Size	Allowable temperature difference
0402, 0603, 0805	$\Delta T \leq 150 \text{ }^\circ\text{C}$

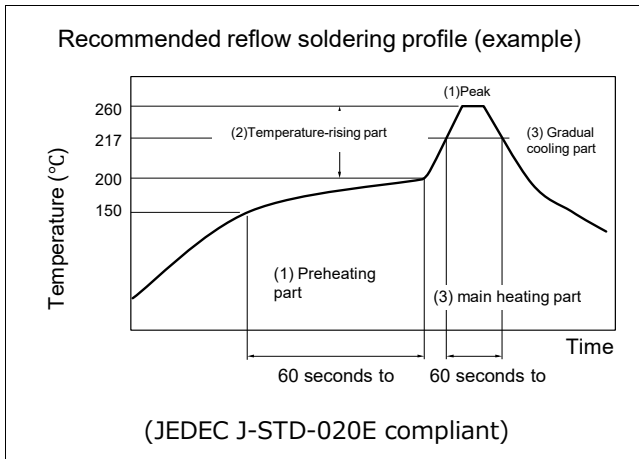

**EZJPR-M 2in1 type**

Items	Temperature condition	Time, heating rate
(1) Preheating part	150 °C to 200 °C	60 to 120 seconds
(2) Temperature-rising part	Preheating temperature to peak temperature	3 °C per second or less
(3) Main heating part	217 °C or higher	60 to 150 seconds
(4) Peak	260 °C or less	—
(5) Gradual cooling part	Peak temperature to 217 °C	6 °C per second or less

Avoid performing rapid cooling (forced cooling) during the gradual cooling part. Rapidly cooling the varistor may result in thermal cracking of the varistor. When dipping the varistor in the cleaning solution right after soldering the varistor, confirm that the surface temperature of the varistor is 100 °C or lower. There is no problem with two cycles of reflow soldering under the recommended reflow soldering profile (example) conditions shown in the above diagram. Be sufficiently careful with deflection or warping of the board.

Note that the recommended soldering conditions indicate conditions under which the degradation of the product characteristics does not occur but do not indicate conditions under which stable soldering can be performed. Check and set conditions under which stable soldering can be performed, on a case-by-case basis.

Varistor temperatures vary depending on the mounted state of the varistor. Make sure to confirm that the surface temperature of the varistor is within the specified temperature when the varistor is mounted and then use the varistor.

• Soldering-iron-used soldering

In soldering-iron soldering, stress created by a rapid temperature change is applied directly to the varistor. Be sufficiently careful in controlling the temperature of the soldering iron tip. Be careful not to let the soldering iron tip come in direct contact with the varistor or its terminal electrode.

The varistor is particularly vulnerable to rapid heating and rapid cooling. When heated or cooled rapidly, the varistor develops excessive heat stress therein resulting from the large temperature difference and because of this heat stress, may thermally crack. Observe the following instructions on preheating, gradual cooling, etc.

Once a varistor soldered with a soldering iron is removed from the board, it cannot be used again.

(1) Condition 1 (preheating included)

- (a) Solder: : Use wire solder (with less chloride content) that is meant for soldering precision electronic equipment. (Wire diameter: 1.0 mm or less)
- (b) Preheating: : Preheat the varistor sufficiently so that the difference between the solder temperature and the surface temperature of the varistor is 150°C or less.
- (c) Temperature of the soldering iron tip : 350°C or lower (a required volume of solder is melted on the soldering iron tip in advance).
- (d) Gradual cooling : After soldering the varistor, leave it in normal temperature conditions to let it cool gradually.

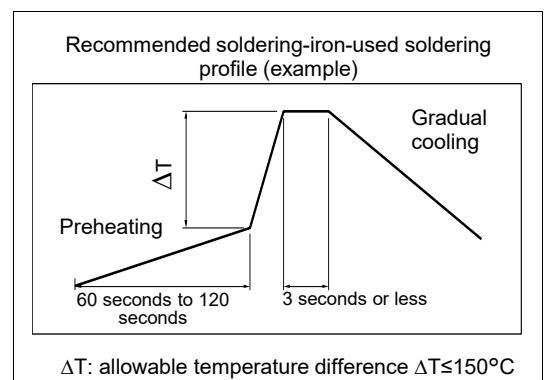

(2) Condition 2 (preheating not included)

If soldering iron tip conditions listed in the table on the right are met, the varistor can be soldered with the soldering iron without preheating the varistor.

- (a) Make sure that the soldering iron tip does not come in direct contact with the varistor or its terminal electrode.
- (b) After preheating the land sufficiently with the soldering-iron tip, slide the soldering-iron tip toward the terminal electrode of the varistor to solder the varistor.

Soldering iron tip conditions in soldering without preheating

Items	Condition
Temperature of the soldering iron tip	350 °C or lower
Wattage	20 W or less
Shape of the soldering iron tip	ø3 mm or less
Soldering-iron applying time	3 seconds or less

<Inspection>

- When the printed board is inspected with measurement terminal pins after the varistor is mounted on the board, the measurement terminal pins pressed against the printed board cause the board to warp, which may cause a crack to form on the varistor.
  - Put the backup pin on the back of the printed board to reduce the warp of the board to 0.5 mm or less with a 90 mm span width.
  - Check whether the shape of the front ends of the measurement terminal pins poses no problem, whether the pins are equal in length, whether the pressure of the pins are not excessively high, and whether the set position of the pins is correct.

Items	Case to avoid	Case recommended
Warp in the board		

<Protective coat>

- When the varistor is coated with or embedded in a resin to improve the varistor's resistance to humidity and gas or to set the varistor stationary, it is expected that the following problems will arise. In such cases, confirm the performance and reliability of the varistor in advance.
  - A solvent included in the resin infiltrates the varistor and impairs its characteristics.
  - Heat from chemical reaction (curing heat) generated by the resin when it cures exerts a negative effect on the varistor.
  - Expansion/shrinkage of the resin applies stress to the soldering part and causes it to crack.

<Splitting a multiple formation printed board>

- When splitting the board having components, including a mounted varistor into multiple pieces, be careful not to apply bending stress or torsional stress to the board. If bending stress or torsional stress, shown in the following diagram, is applied to the board when it is split, the varistor may develop a crack. Avoid, as much as possible, applying stress to the board.

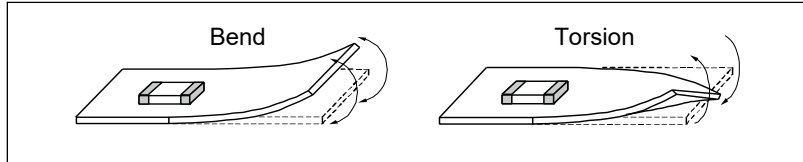

- Avoid manually splitting the board so as to keep mechanical stress to the board as small as possible. When splitting the board, use a splitting jig or a board splitter.
- Example of a board splitting jig is shown in the following diagram. Holding the part of the board that is far from the jig and applying a load bend the board excessively. Holding the part of the board that is closer to the jig and applying a load allow you to split the board with less bending.

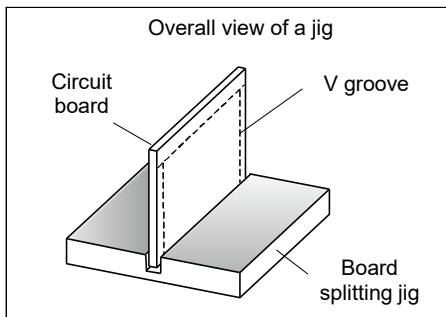

Case to avoid	Case recommended

**Storage conditions**

- Avoid a high-temperature/high-humidity storage place and keep the varistor in a storage place where temperature ranges from 5 °C to 40 °C and relative humidity ranges from 20% to 70%.
- Do not store the varistor in a place where moisture, dust, or corrosive gas (hydrogen chloride, hydrogen sulfide, sulfur dioxide, ammonia, etc.) is present. It may impair the solderability of the terminal electrode. Also, in places where the varistor package is exposed to heat, direct sunlight, etc., packaging tape may deform or stick to the varistor which causes a problem when the varistor is mounted. Be careful in such cases.
- A varistor storage period shall be 12 months or less. When using a varistor kept in storage for more than 12 months, confirm its solderability before using it.

## Multilayer Varistor

For ESD pulse [Automotive grade]

**EZJZ-M, EZJP-M series**

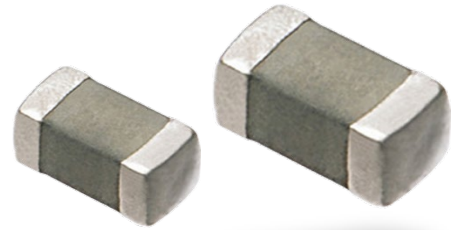

### Features

- Excellent ESD suppression due to original advanced material technology
- Having large electrostatic resistance meeting IEC61000-4-2, ISO10605
- Having no polarity (bipolar) facilitated replacing Zener Diodes. Capable of replacing 2 Zener Diodes and 1 Capacitor
- Lead-free plating terminal electrodes enabling great solderability
- Wide range of products is available by adopting multilayer structure, meeting various needs
- RoHS compliant
- Automotive grade (this product can be tested under the conditions according to AEC-Q200 and the test results can be submitted.)

### Explanation of part numbers

1 2 3 4 5 6 7 8 9 10 11 Example

**E** **Z** **J** **P** **0** **V** **2** **7** **0** **E** **M**

Product code Automotive grade

Code	Series
Z	EZJZ
P	EZJP

Code	Dimensions (mm) (inch)
0	1005 (0402)
1	1608 (0603)
2	2012 (0805)

Code	Packaging style
V	0402, 0603 Punched carrier taping 0805
Y	Embossed carrier tape

Nominal varistor voltage

The first and second digits denote the first 2 numbers of the varistor voltage and the third digit indicates the number of zeros following. The decimal point denotes in R.

Code	Capacitance	Code	Capacitance
B	10 pF	F	68 pF
R	20 pF	G	100 pF
D	27 pF	H	150 pF
E	47 pF	J	220 pF
W	56 pF	K	330 pF

### Construction

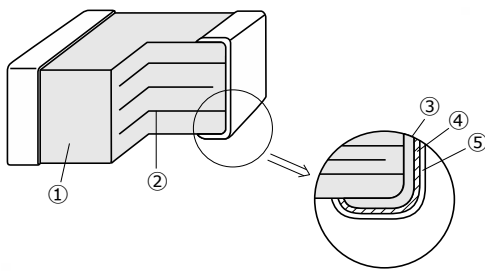

#### [Composition]

No.	Name	
①	Zinc oxide-based ceramics	
②	Internal electrode	
③	Terminal electrode	Substrate electrode
④		Intermediate electrode
⑤		External electrode

### Dimensions in mm (not to scale)

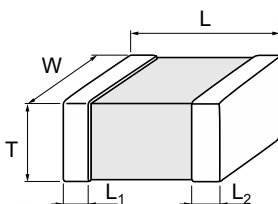

Unit : mm

Size code	Size(inch)	L	W	T	L <sub>1</sub> , L <sub>2</sub>
0	0402	1.00 ± 0.05	0.50 ± 0.05	0.50 ± 0.05	0.2 ± 0.1
1	0603	1.6 ± 0.1	0.8 ± 0.1	0.8 ± 0.1	0.3 ± 0.2
2	0805	2.0 ± 0.2	1.25 ± 0.2	1.25 ± 0.2	0.5 ± 0.25

# Multilayer Varistor (Automotive grade) / EZJZ-M, EZJP-M series

## Features

Wide variety of products is available by adopting multilayer construction, which achieved wide range of usage, such as application to DC voltage lines and signal lines.

- Varistor voltage : 12 to 100 V (at 1 mA)
- Capacitance : 10 to 220 pF max. (at 1 MHz)

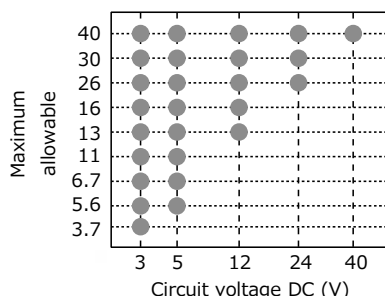

## Recommended applications

- Engine ECU
- Various body ECU
- Communication line, such as CAN, LIN
- Audio, Navigation
- LED Light
- Control SW

## Ratings and characteristics

Size (inch)	Part No.	Maximum allowable voltage DC (V)	Nominal varistor voltage at 1 mA (V)	Capacitance (pF)		Maximum peak current at 8/20 μs, 2 times (A)	Clamping Voltage at 8/20 μs (V)	Maximum ESD
				at 1 MHz	at 1 kHz			
0402	EZJP0V120JM	7.5	12 (9.6 to 14.4)	220 max. [150 typ.]	175 typ.	10	30 max. (1A)	IEC61000-4-2 150 pF/ 330 Ω Contact discharge 8 kV <sup>2</sup>
	EZJP0V180HM	11	18 (14.4 to 21.6)	150 max. [120 typ.]	140 typ.	10	38 max. (1A)	
	EZJP0V220HM	13	22 (17.6 to 26.4)	150 max. [100 typ.]	116 typ.	10	48 max. (1A)	
	EZJP0V240JM	16	24 (21.6 to 28.8)	—	200 typ. <sup>+10 %</sup> <sub>-20 %</sub>	10	48 max. (1A)	
	EZJP0V270GM	18	27 (21.6 to 32.4)	100 max. [85 typ.]	100 typ.	10	50 max. (1A)	
	EZJP0V270EM	18	27 (21.6 to 32.4)	47 max. [33 typ.]	37 typ.	4	50 max. (1A)	
	EZJP0V270RM	18	27 (21.6 to 32.4)	20 max. [15 typ.]	16.5 typ.	2	50 max. (1A)	
	EZJP0V270BM	18	27 (21.6 to 32.4)	10 max. [8 typ.]	10 typ.	—	—	
	EZJP0V330GM	25	33 (29.4 to 39.6)	100 max. [85 typ.]	100 typ.	10	58 max. (1A)	
	EZJP0V420WM	30	42 (33.6 to 50.4)	56 max. [40 typ.]	45 typ.	6	80 max. (1A)	
	EZJP0V650DM	40	65 (52.0 to 78.0)	27 max. [22 typ.]	33 typ.	2	120 max. (1A)	
0603	EZJP0V101BM	30	100 (80 to 120)	10 max. [8 typ.]	10 typ.	—	—	ISO10605 330 pF/ 2k Ω Contact discharge 25 kV
	EZJP1V120KM	7.5	12 (10.6 to 15.4)	330 max. [250 typ.]	290 typ.	20	30 max. (2A)	
	EZJP1V180JM	11	18 (14.4 to 21.6)	220 max. [180 typ.]	210 typ.	20	38 max. (2A)	
	EZJP1V220JM	13	22 (17.6 to 26.4)	220 max. [160 typ.]	185 typ.	10	44 max. (2A)	
	EZJP1V270GM	18	27 (21.6 to 32.4)	100 max. [85 typ.]	100 typ.	10	52 max. (2A)	
	EZJP1V270EM	18	27 (21.6 to 32.4)	47 max. [33 typ.]	37 typ.	5	55 max. (2A)	
	EZJP1V270RM	18	27 (21.6 to 32.4)	20 max. [15 typ.]	16.5 typ.	2	60 max. (2A)	
	EZJP1V330GM	25	33 (29.4 to 39.6)	100 max. [85 typ.]	100 typ.	10	58 max. (2A)	
	EZJP1V420FM	30	42 (33.6 to 50.4)	68 max. [55 typ.]	63 typ.	8	80 max. (2A)	
	EZJP1V650DM	40	65 (52.0 to 78.0)	27 max. [22 typ.]	33 typ.	6	150 max. (2A)	
	EZJZ1V180JM	11	18 (14.4 to 21.6)	220 max. [180 typ.]	210 typ.	20	38 max. (2A)	
	EZJZ1V220JM	13	22 (19.8 to 24.2)	220 max. [160 typ.]	185 typ.	20	44 max. (2A)	
	EZJZ1V270GM	18	27 (25.4 to 30.8)	100 max. [85 typ.]	100 typ.	20	50 max. (2A)	
	EZJZ1V270EM	18	27 (25.4 to 30.8)	47 max. [33 typ.]	37 typ.	10	56 max. (2A)	
	EZJZ1V270RM	18	27 (25.4 to 30.8)	20 max. [15 typ.]	16.5 typ.	3	50 max. (1A)	
	EZJZ1V330GM	26	33 (30.6 to 37.4)	100 max. [85 typ.]	100 typ.	20	58 max. (2A)	
	EZJZ1V420FM	30	42 (37.8 to 46.2)	68 max. [55 typ.]	63 typ.	15	80 max. (2A)	
EZJZ1V650DM	40	65 (58.5 to 71.5)	27 max. [22 typ.]	33 typ.	5	120 max. (2A)		
0805	EZJZ2Y390KM	31	39 (35.1 to 42.9)	330 max. [210 typ.]	250 typ.	80 <sup>*1</sup>	67 max. (1A)	

- Operating temperature range : EZJP-M series -55 to 150 °C  
EZJZ-M series -55 to 125 °C

\*1: Surge 1 time

\*2: 25kV for EZJP0V240JM

\* Recommend soldering method : Reflow soldering

[Terms]

Maximum allowable voltage	Maximum DC Voltage that can be applied continuously within the operating temperature range
Varistor voltage	Varistor starting voltage between terminals at DC 1 mA, also known as Breakdown voltage
Maximum peak current	Maximum current that can be withstood under the standard pulse 8/20 μs, 2 times based
Clamping voltage	The maximum voltage between two terminals with the specified impulse current (8/20 μs)
Maximum ESD	Maximum voltage that can be withstood under ESD

Design and specifications are each subject to change without notice. Ask factory for the current technical specifications before purchase and/or use.  
Should a safety concern arise regarding this product, please be sure to contact us immediately.

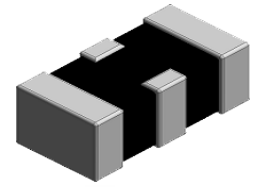

## Multilayer Varistor

For ESD pulse [Automotive grade]

**EZJPR-M series 2in1 type**

### Features

- Excellent ESD suppression due to original advanced material technology
- Reducing capacitance difference to 1.0 pF or less by the 2in1 structure and realizing a high communication signal quality
- Achieving both high ESD protection and EMC performance (ensuring high communication stability through EMC testing)
- Contributing to reducing environmental impact by reducing materials and energy used in customers' processes
- Having large electrostatic resistance meeting IEC61000-4-2, ISO10605
- Excellent BCI test withstanding
- Lead-free plating terminal electrodes enabling great solderability
- RoHS compliant
- Automotive grade (this product can be tested under the conditions according to AEC-Q200 and the test results can be submitted.)

### Explanation of part numbers

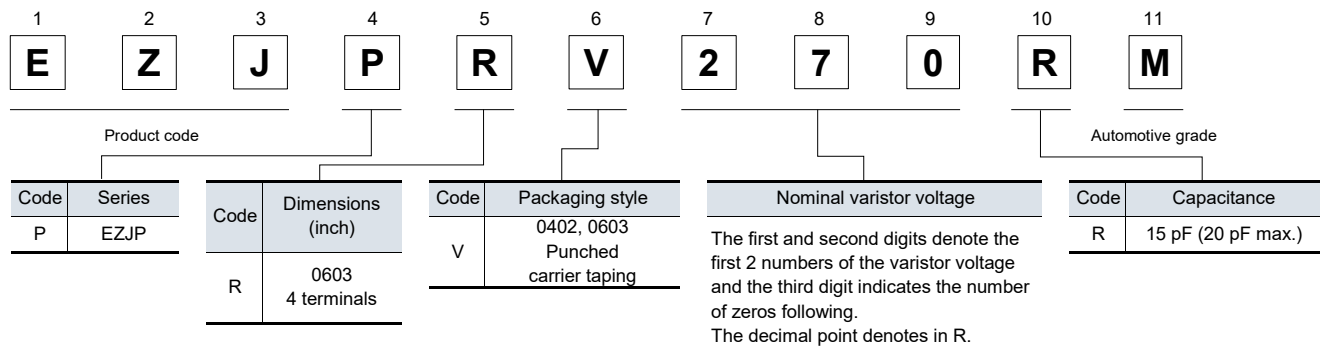

### Construction

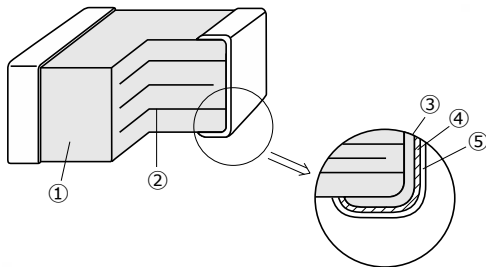

#### [Composition]

No.	Name
①	Zinc oxide-based ceramics
②	Internal electrode
③	Substrate electrode
④	Terminal electrode
⑤	Intermediate electrode
	External electrode

### Dimensions in mm (not to scale)

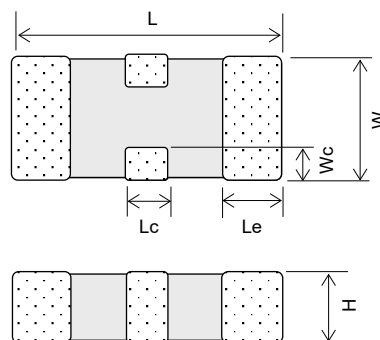

Size code	Size	L	W	H	Le	Lc	Wc
R	0603	1.60 ± 0.15	0.80 ± 0.10	0.70 max.	0.30 ± 0.15	0.30 ± 0.15	0.18 ± 0.10

Unit : mm

**Equivalent circuit**

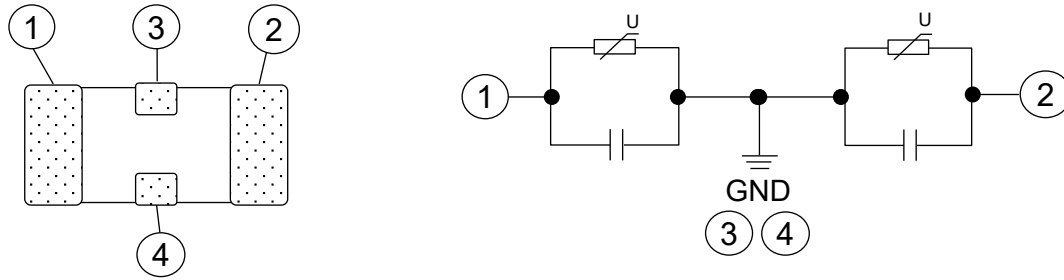

**Application**

Suitable component as ESD countermeasure for CAN-FD/CAN lines

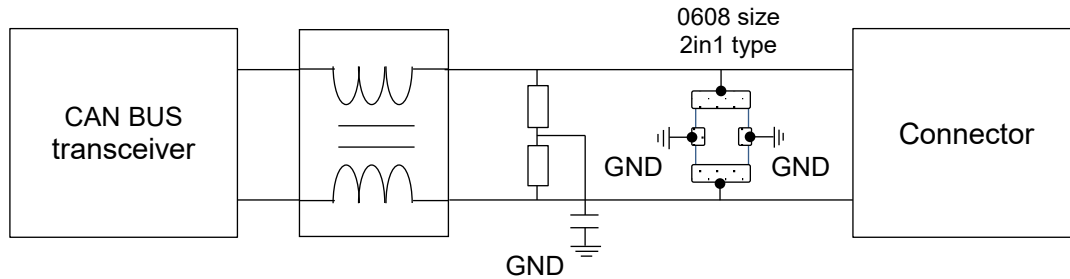

- Securing high quality signal by minimizing characteristic difference between high and low lines by 2in1 type original design (Necessity to comply with S-parameter frequency characteristic requirement)
- High destruction limit performance and excellent BCI test withstanding compared to TVS diode
- Reducing footprint and number of parts by 2in1 design

**Ratings and characteristics**

Size (inch)	Part No.	Maximum allowable voltage DC (V)	Nominal varistor voltage at 1 mA (V)	Capacitance (pF) at 1 MHz	Capacitance difference (pF) at 1 MHz	Maximum peak current at 8/20 μs, 2 times (A)	Clamping voltage at 8/20 μs (V)	Maximum ESD	
								IEC61000-4-2 150 pF/ 330 Ω	ISO10605 330 pF/ 2k Ω
0603	EZJPRV270RM	18	27 (24.3 to 32.4)	15.0 ± 3.0	1.0 max.	1	60 max. (1A)	Contact discharge 25 kV	Contact discharge 25 kV

● Operating temperature range : -55 to 150 °C

\* Recommend soldering method : Reflow soldering

[Terms]

Maximum allowable voltage	Maximum DC Voltage that can be applied continuously within the operating temperature range
Varistor voltage	Varistor starting voltage between terminals at DC 1 mA, also known as Breakdown voltage
Capacitance	Capacitance value between each terminal and ground terminal at measurement frequency 1MHz and measurement voltage 1.0Vrms
Capacitance difference	Absolute value of the difference of the capacitance between the channels at measurement frequency 1MHz and measurement voltage 1.0Vrms
Maximum peak current	Maximum current that can be withstood under the standard pulse 8/20 μs, 2 times based
Clamping voltage	The maximum voltage between two terminals with the specified impulse current (8/20 μs)
Maximum ESD	Maximum voltage that can be withstood under ESD

# Multilayer Varistors (Automotive grade) EZJZ-M, EZJP-M series / Characteristics

## Varistor characteristics and equivalent circuit

A Multilayer Varistor does not have an electrical polarity like Zener diodes and is equivalent to total 3 pcs of 2 zener Z

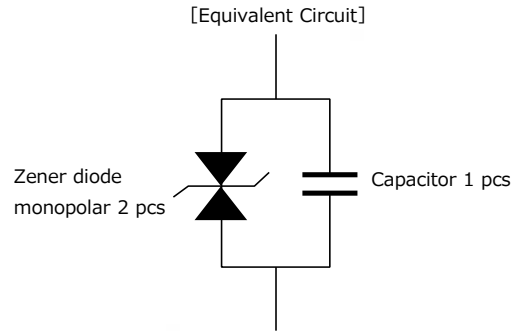
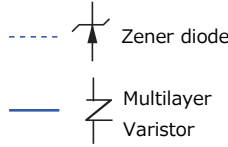
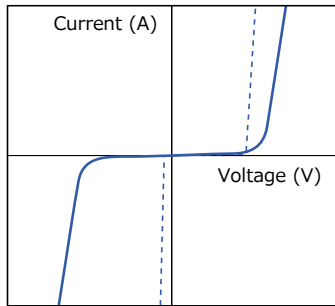

## ESD Suppressive effects

Typical effects of ESD suppression  
Test conditions :  
IEC61000-4-2\* Level 4 Contact discharge, 8 kV

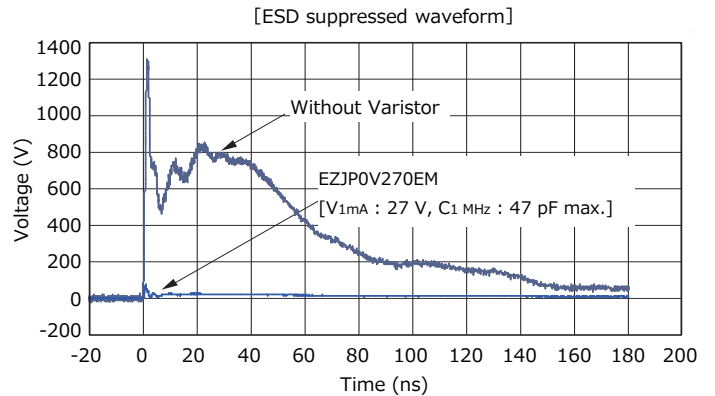
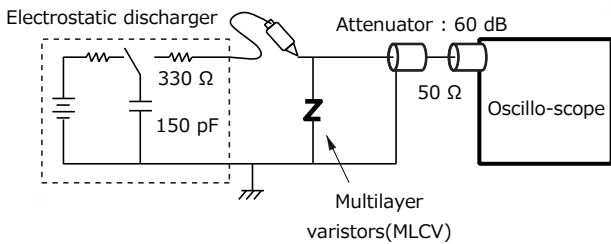

\*IEC61000-4-2 ... International Standard of the ESD testing method (HBM) for electronic equipment ability to withstand ESD generated from a human body. It sets 4 levels of severity

Severity	Level 1	Level 2	Level 3	Level 4
Contact discharge	2 kV	4 kV	6 kV	8 kV
Air discharge	2 kV	4 kV	8 kV	15 kV

## Replacement of Zener diode

Replacing "Zener diode and Capacitor" with Multilayer Varistor saves both the mounting area and number of components used.

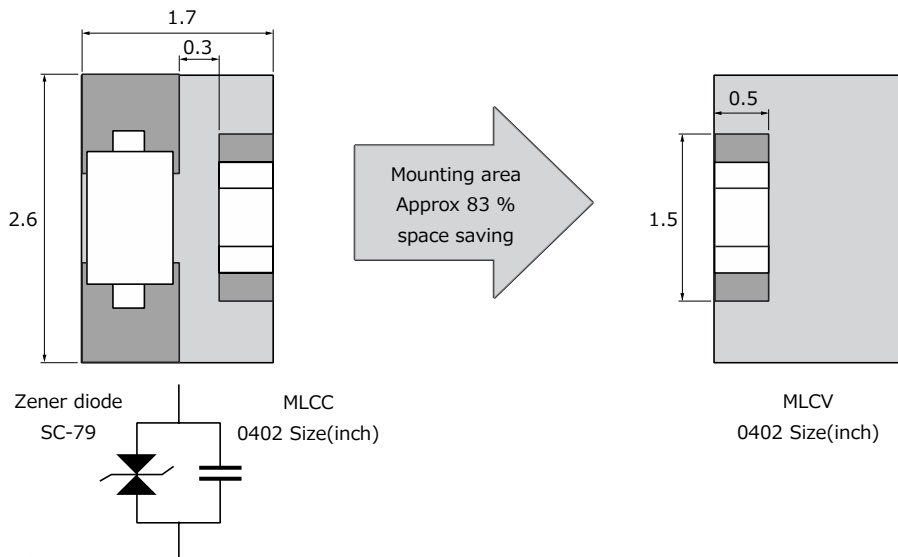

## Multilayer Varistors (Automotive grade) EZJZ-M, EZJP-M series / Performance and testing

### Performance and testing methods

Characteristics	Specifications	Testing method
Standard test conditions		Electrical characteristics shall be measured under the following conditions. Temp. : 5 to 35 °C, Relative humidity : 85 % or less
Varistor voltage	To meet the specified value.	The Varistor voltage is the voltage ( $V_C$ , or $V_{cmA}$ ) between both end terminals of a Varistor when specified current ( $CmA$ ) is applied to it. The measurement shall be made as quickly as possible to avoid heating effects.
Maximum allowable voltage	To meet the specified value.	The maximum DC voltage that can be applied continuously to a varistor.
Capacitance	To meet the specified value.	Capacitance shall be measured at the specified frequency, bias voltage 0 V, and measuring voltage 0.2 to 2.0 Vrms
Capacitance difference	To meet the specified value.	Capacitance shall be measured at the specified frequency, bias voltage 0 V, and measuring voltage 0.2 to 2.0 Vrms
Maximum peak current	To meet the specified value.	The maximum current measured (Varistor voltage tolerance is within $\pm 10\%$ ) when a standard impulse current of 8/20 $\mu$ seconds is applied twice with an interval of 5 minutes.
Maximum ESD	To meet the specified value.	The maximum ESD measured (while the varistor voltage is within blow ranges of its nominal value) when exposed to ESD 10 times (five times for each positive-negative polarity) based on IEC61000-4-2, ISO10605. EZJP□□□□□□M : within $\pm 10\%$ , EZJZ□□□□□□M : within $\pm 30\%$
Solder ability	To meet the specified value.	<p>■ The part shall be immersed into a soldering bath under the conditions below.</p> <p>(1) Except EZJPR-M 2in1 type  Solder : Sn-3.0Ag-0.5Cu  Preheating : 140 to 180 °C, 60 to 120 sec  Temp. rising : Preheating temp. to Peak temp., 2 to 5 °C/sec  Heating : 220 °C min., 60 sec max.  Peak temp. : 260 °C max, 10 sec max.  Gradual cooling : Peak temp. to 140 °C, 1 to 4 °C/sec</p> <p>(2) EZJPR-M 2in1 type  Solder : Sn-3.0Ag-0.5Cu  Preheating : 150 to 200 °C, 60 to 120 sec  Temp. rising : Preheating temp. to Peak temp., 3 °C/sec max.  Heating : 217 °C min., 60 to 150 sec  Peak temp. : 260 °C max.  Gradual cooling : Peak temp. to 217 °C, 6 °C/sec max.</p>
Resistance to soldering heat	$\Delta V_C/V_C$ : within $\pm 10\%$	<p>■ The part shall be immersed into a soldering bath under the conditions below.</p> <p>(1) Except EZJPR-M 2in1 type  After the immersion into a soldering bath, leave the part for <math>24 \pm 2</math> hours under the standard condition, then evaluate its characteristics. Soldering conditions are specified below:  Soldering conditions : <math>270 \pm 5</math> °C, <math>3.0 \pm 0.5</math> s  Soldering position : Immerse both terminal electrodes until they are completely into the soldering bath.</p> <p>(2) EZJPR-M 2in1 type  After the reflow soldering, leave the part for <math>24 \pm 2</math> hours under the standard condition, then evaluate its characteristics. Soldering conditions are specified below:  Solder : Sn-3.0Ag-0.5Cu  Number of reflow : 3 times  Preheating : 150 to 200 °C, 60 to 120 sec  Temp. rising : Preheating temp. to Peak temp., 3 °C/sec max.  Heating : 217 °C min., 60 to 150 sec  Peak temp. : 260 °C max.  Gradual cooling : Peak temp. to 217 °C, 6 °C/sec max.</p>

## Multilayer Varistors (Automotive grade) EZJZ-M, EZJP-M series / Performance and testing

### Performance and testing methods

Characteristics	Specifications	Testing method															
Temperature cycling	$\Delta V_c/V_c$ : within $\pm 10$ %	<p>After repeating the cycles stated below for specified number of times, leave the part for <math>24 \pm 2</math> hours, then evaluate its characteristics.</p> <p>Cycle : 2000 cycles</p> <table border="1"> <thead> <tr> <th>Step</th> <th>Temperature</th> <th>Period</th> </tr> </thead> <tbody> <tr> <td>1</td> <td>Max. operating temp.</td> <td><math>30 \pm 3</math> min</td> </tr> <tr> <td>2</td> <td>Ordinary temp.</td> <td>3 min max.</td> </tr> <tr> <td>3</td> <td>Min. operating temp.</td> <td><math>30 \pm 3</math> min</td> </tr> <tr> <td>4</td> <td>Ordinary temp.</td> <td>3 min max.</td> </tr> </tbody> </table>	Step	Temperature	Period	1	Max. operating temp.	$30 \pm 3$ min	2	Ordinary temp.	3 min max.	3	Min. operating temp.	$30 \pm 3$ min	4	Ordinary temp.	3 min max.
Step	Temperature	Period															
1	Max. operating temp.	$30 \pm 3$ min															
2	Ordinary temp.	3 min max.															
3	Min. operating temp.	$30 \pm 3$ min															
4	Ordinary temp.	3 min max.															
Vibration	$\Delta V_c/V_c$ : within $\pm 10$ %	<p>The varistor shall be soldered on the testing board shown.</p> <p>G force : 5 G</p> <p>Vibration frequency range : 10 to 2000 Hz</p> <p>Sweet time : 20 min.</p> <p>Sweet direction : 12 cycles for 3 courses perpendicular each other</p>															
Mechanical shock	$\Delta V_c/V_c$ : within $\pm 10$ %	<p>The varistor shall be soldered on the testing board shown.</p> <p>Shock-wave formation : Half sine , 11 ms</p> <p>G force : 50 G</p> <p>Sweet direction : 6 directions of X, Y, Z, for each three times</p>															
Biased humidity	$\Delta V_c/V_c$ : within $\pm 10$ %	<p>After conducting the test under the conditions specified below, leave the part <math>24 \pm 2</math> hours, then evaluate its characteristics.</p> <p>Temperature : <math>85 \pm 2</math> °C</p> <p>Humidity : 80 to 85 %RH</p> <p>Applied voltage : Maximum allowable voltage (Individually specified)</p> <p>Period : 2000+24/0 h</p>															
High temperature exposure (dry heat)	$\Delta V_c/V_c$ : within $\pm 10$ %	<p>After conducting the test under the conditions specified below, leave the part <math>24 \pm 2</math> hours, then evaluate its characteristics.</p> <p>Temperature : Maximum operating temperature <math>\pm 3</math> °C (Individually specified)</p> <p>Applied voltage : Maximum allowable voltage (Individually specified)</p> <p>Period : 2000+24/0 h</p>															

# Multilayer Varistors (Automotive grade) EZJZ-M, EZJP-M series / Packaging

## Packaging methods (Taping)

### ● Standard quantity

Series	Size code (inch size)	Thickness (mm)	Kind of taping	Pitch (mm)	Quantity (pcs/reel)
EZJZ, EZJP	0 (0402)	0.5	Punched carrier taping	2	10,000
	1 (0603)	0.8		4	4,000
		0.7 max.			5,000
	2 (0805)	1.25	Embossed carrier tape		2,000

### ● 2 mm Pitch (Punched carrier taping) Size 0402

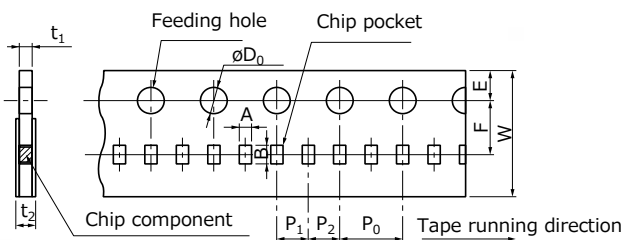

### ● 4 mm Pitch (Punched carrier taping) Size 0603

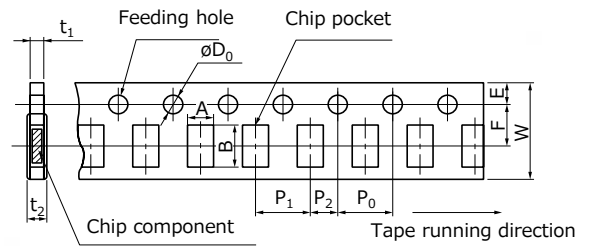

Unit : mm

Code	A	B	W	F	E	P <sub>1</sub>	P <sub>2</sub>	P <sub>0</sub>	øD <sub>0</sub>	t <sub>1</sub>	t <sub>2</sub>
EZJZ	0.62	1.12	8.0	3.50	1.75	2.00	2.00	4.0	1.5	0.7	1.0
EZJP	±0.05	±0.05	±0.2	±0.05	±0.10	±0.05	±0.05	±0.1	+0.1 0	max.	max.

Unit : mm

Code	A	B <sup>1</sup>	W	F	E	P <sub>1</sub>	P <sub>2</sub>	P <sub>0</sub>	øD <sub>0</sub>	t <sub>1</sub>	t <sub>2</sub> <sup>2</sup>
EZJZ	1.0	1.8	8.0	3.50	1.75	4.0	2.00	4.0	1.5	1.1	1.4
EZJP	±0.1	±0.1	±0.2	±0.05	±0.10	±0.1	±0.05	±0.1	+0.1 0	max.	max.

\*1 : 1.77 ± 0.1 for 5,000 pcs/reel

\*2 : 1.3 max. for 5,000 pcs/reel

### ● 4 mm Pitch (Embossed carrier tape) Size 0805

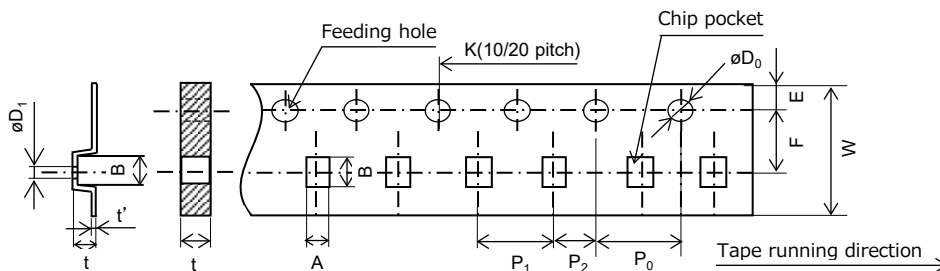

Unit : mm

Code	A	B	W	F	E	P <sub>1</sub>	P <sub>2</sub>	P <sub>0</sub>	øD <sub>0</sub>	t	t'	K
EZJZ	1.45	2.25	8.0	3.50	1.75	4.0	2.00	4.0	1.5	1.42	0.25	40.0
EZJP	±0.1	±0.1	±0.2	±0.05	±0.10	±0.1	±0.05	±0.1	+0.1 0	±0.1	±0.05	+0.15/ 10 pitch

### ● Reel for taping

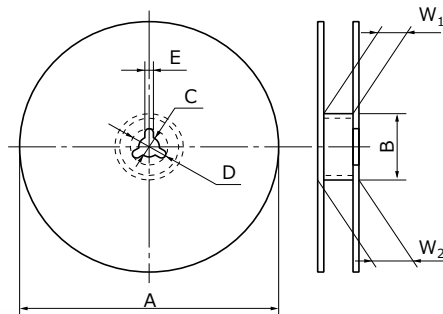

Unit : mm

Code	A	B	C	D	E	W <sub>1</sub>	W <sub>2</sub>
EZJZ	ø180 <sub>0</sub>	ø60.0 <sub>+1.0</sub>	13.0 <sub>±0.5</sub>	21.0 <sub>±0.8</sub>	2.0 <sub>±0.5</sub>	9.0 <sub>+1.0</sub>	11.4 <sub>±1.0</sub>
EZJP	-3	0				0	

### ● Leader part and taped end

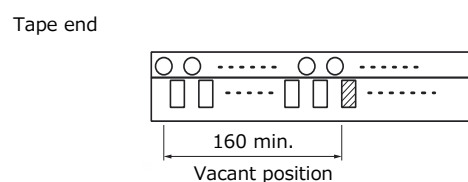
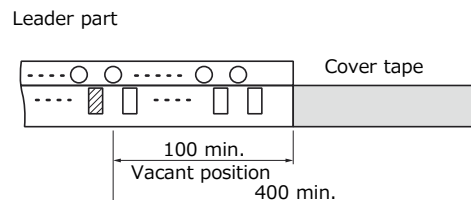

Unit : mm

## ■ As for packaging methods, handling precautions please see data files

## Matters to Be Observed When Using This Product

### (Chip-type laminated varistor)

#### Safety measures

- A chip-type laminated varistor (hereinafter “the product” or “the varistor”) is intended for use in general-purpose and standard applications, such as electrostatic control/noise suppression, in general electronic equipment (AV products, household appliances, office equipment, information/communication devices, etc.). The varistor may deteriorate in performance or fail (short or open mode) when used improperly.
- If the varistor in short mode is used, applied voltage may cause a large current to flow through the varistor. Consequently, the varistor heats up and may burn the circuit board. An abnormal state of the varistor that results from a problem with its service conditions (use environment, design conditions, mounting conditions, etc.) may lead to, in a worst case scenario, burnout of the circuit board, serious accident, etc. Sufficiently check for what is described below before using the varistor.

#### Use environments and cleaning conditions

- This product (varistor) is not designed for use in the specific environments described below. Using the product in such specific environments or service conditions, therefore, may affect the performance of the product. Please check the performance and reliability of the product first and then use the product.
  - (1) Used in liquid, such as water, oil, chemicals, and organic solvents.
  - (2) Used in a place exposed to direct sunlight, an outdoor place with no shielding, or a dusty place.
  - (3) Used in a place where the product is heavily exposed to sea breeze or a corrosive gas, such as Cl<sub>2</sub>, H<sub>2</sub>S, NH<sub>3</sub>, SO<sub>2</sub>, or NO<sub>x</sub>.
  - (4) Used in an environment where electromagnetic waves and radiation are strong.
  - (5) Located close to a heating component or a flammable material, such as a vinyl cable.
  - (6) Sealed or coated with a resin, etc.
  - (7) Solder flux of the soldered product is cleansed with a solvent, water, and a water-soluble cleaner (be careful with solder flux soluble to water).
  - (8) Used in a place where dew concentrates on the product.
  - (9) Used in a contaminated state. (Example) Touching a varistor (with uncovered skin) mounted on a printed board leaves sebum on the varistor. Do not handle the varistor in this manner.
  - (10) Used in a place where excessive vibration or impact is applied to the product.
- Use the varistor within the range of its specified ratings/capabilities. Using the varistor under severe service conditions that are beyond the specified ratings/capabilities causes degraded performance or destruction of the varistor, which may lead to scattering of varistor fragments, smoke generation, ignition, etc. Do not use the varistor at a working temperature or maximum allowable circuit voltage that exceeds the specified working temperature or maximum allowable circuit voltage. Do not locate the varistor close to combustible materials.
- In an improper cleaning solution, with which the varistor is cleaned, flux residues or other foreign matter may stick to the surface of the varistor, which degrades the performance (insulation resistance, etc.) of the varistor. In a polluted cleaning solution, the concentration of free halogen, etc., is high, and may result in poor/insufficient cleaning.
- Improper cleaning conditions (insufficient cleaning or excessive cleaning) may impair the performance of the varistor.
  - (1) Insufficient cleaning
    - (a) A halogenous substance in flux residues may corrode a metal element, such as a terminal electrode.
    - (b) A halogenous substance in flux residues may stick to the surface of the varistor and lower its insulation resistance.
    - (c) Tendencies described in (a) and (b) may be more notable with water-soluble flux than with rosin-based flux.

Be careful about insufficient cleaning.
  - (2) Excessive cleaning

Ultrasonic waves that are too powerful from an ultrasonic cleaner cause the board to resonate, in which case the vibration of the board may cause the varistor or a soldered part to crack or reduce the strength of the terminal electrode. Keep power output from the ultrasonic cleaner at 20 W/L or lower, its ultrasonic frequency at 40 kHz or lower, and an ultrasonic cleaning time at 5 minutes or less.

## Response to anomalies and handling conditions

- Do not apply excessive mechanical impact to the varistor. Because the varistor body is made of ceramic, drop impact to the varistor readily damages or cracks the varistor. Once dropped on the floor, etc., the varistor may have lost its sound quality and become failure-prone. Do not use said varistor.
- When handling the board carrying the varistor, be careful not to let the varistor hit against another board. Take extra caution when handling or storing a stack of boards carrying varistors. There are cases where a corner of a board will hit against a varistor and damage or crack it, which may result in a failure of the varistor, such as a drop in its insulation resistance. Do not reuse a varistor that has been used on and removed from a board.

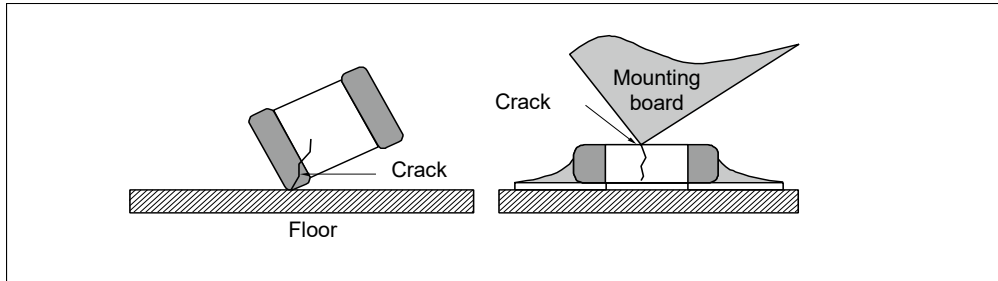

## Reliability

To know the detailed specifications of individual products or specific evaluation test scores, please contact us. We issue a delivery specification sheet for each product ordered. Please confirm with the sheet when you place an order with us.

## Circuit design and circuit board design

- A working temperature at which a varistor works in the circuit must be within the working temperature range specified in the specification sheet. A temperature at which a varistor incorporated in the circuit is kept in storage without operating must be within the storage temperature range specified in the specification sheet. Do not use the varistor at a higher temperature than the maximum working temperature.
- Keep voltage applied across the terminals of the varistor equal to or lower than the maximum allowable circuit voltage. Applying improper voltage to the terminals may cause the varistor to fail or short-circuit thus generate heat. When using the varistor in a circuit where high-frequency voltage or pulse voltage of an acute waveform is applied consecutively, even if the applied voltage is lower than the rated voltage, confirm that the varistor is reliable enough to operate normally in the circuit.
- Ensure that the surface temperature of the varistor, which includes a temperature increment resulting from self-heating, is equal to or lower than the highest working temperature specified in the delivery specification sheet. Check the temperature of the varistor under the circuit conditions used in the operation state of the device in which the varistor is incorporated.
- Using the varistor on an alumina board has an expectation of performance degradation due to thermal impact (temperature cycle). Before using the varistor, sufficiently confirm that the board does not affect the quality of the varistor.

## Mounting conditions

- The more solder deposited on the varistor, the greater the stress to the varistor, which leads to cracking of the varistor. When designing a land on the board, determine the shape and dimensions of the land so that a proper volume of solder is applied in the land. Design the land such that its left and right sides are equal in size. In a case where solder volumes are different between the left and right sides of the land, a greater volume of solder takes more time to cool and solidify. As a result, stress acts on one side which may crack the varistor.

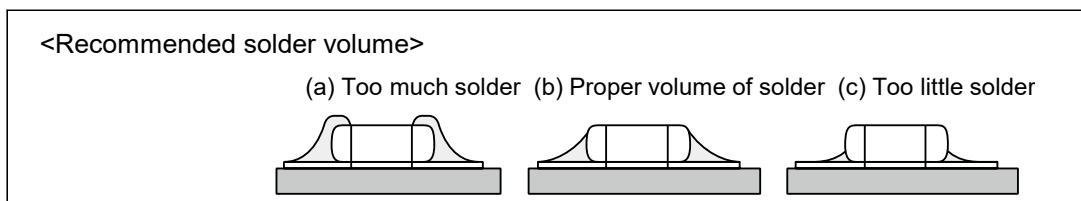

<Recommended land dimensions (example)>

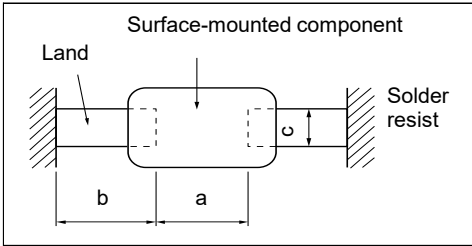

Shape symbol (JIS size)	Component dimensions			a	b	c
	L	W	T			
Z (0603)	0.6	0.3	0.3	0.2 to 0.3	0.25 to 0.30	0.2 to 0.3
0 (1005)	1.0	0.5	0.5	0.4 to 0.5	0.4 to 0.5	0.4 to 0.5
1 (1608)	1.6	0.8	0.8	0.8 to 1.0	0.6 to 0.8	0.6 to 0.8
2 (2012)	2.0	1.25	0.8 to 1.25	0.8 to 1.2	0.8 to 1.0	0.8 to 1.0

Unit: mm

<Using solder resist>

- Use solder resist to evenly distribute solder volumes on the left and right sides.
- When a component is located close to the varistor, the varistor is mounted together with a lead-attached component, or a chassis is located close to the varistor, separate solder patterns from each other using the solder resist.

\* Refer to cases to avoid and recommended examples shown on the right table.

Items	Case to avoid	Case recommended
		(Example of improving soldering by separating solder patterns)
Mounting the varistor together with a lead-attached component	Lead of a lead-attached component	Solder resist
Soldering in the vicinity of the chassis	Chassis Solder (earth solder) Electrode pattern	Solder resist
Soldering a lead-attached component later	Lead of a component mounted later Solder iron	Solder resist
Placing the products side by side	Part where too much solder is applied Land	Solder resist

<Varistor placement that avoids stress caused by warp in the board>

- When the board warps during or after soldering of the varistor to the board, the warping of the board may cause the varistor to crack. Place the varistor so that stress caused by the warp is negligible to the varistor.

\* Refer to the case to avoid and a case recommended example shown on the right table.

Case to avoid	Case recommended
	 Set the varistor sideways relative to the direction in which stress acts.

<Mechanical stress near a breaking line of the board>

- Mechanical stresses to the varistor near a breaking line of the board vary depending on the mounting position of the varistor. Refer to the figure on the right.
- The varistor receives mechanical stresses different in size when the board is broken by different methods. The size of the stress the varistor receives is smaller in the following order: pushing back<breaking along a slit<breaking along a V groove<breaking along a perforated line. In addition to varistor placement, consider the board breaking method as well.

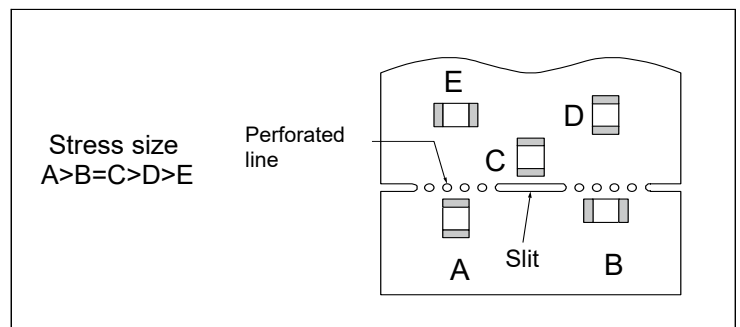

<Mounting density and space between components>

- When space between components is too narrow, solder bridges or solder balls have negative effects on the components. Be careful to provide proper space between the components.

## &lt;Mounting on the board&gt;

- When the varistor is mounted on the board, an excessive impact load, such as pressure from a suction nozzle for mounting the varistor and mechanical impact/stress caused by a positional shift or positioning, may be applied to the varistor. Prevent application of such an excessive impact load to the varistor.
- A mounter needs to be checked and maintained regularly.
- When the bottom dead center of the suction nozzle is too low, an excessively large force is applied to the varistor when it is mounted, which may crack the varistor. Heed the following instructions when using the suction nozzle.
  - (1) Set the bottom dead center of the suction nozzle at the upper surface of the straightened board.
  - (2) Set the pressure of the suction nozzle equal to a static load between 1 N to 3 N.
  - (3) In the case of double-face mounting, put a backup pin on the lower surface (back) of the board to prevent the board from warping. This keeps the impact of the suction nozzle as small as possible. Typical examples of using the backup pin are shown in the following table.

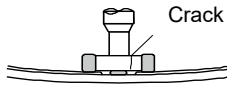
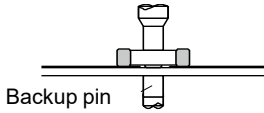
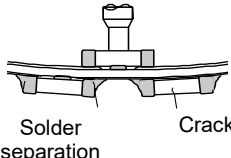
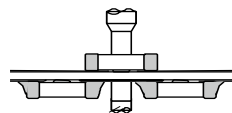
Items	Case to avoid	Case recommended
Single-face mounting	 Crack	The backup pin does not always need to be underneath the varistor.  Backup pin
Double-face mounting	 Solder separation Crack	 Backup pin

(4) Adjust the suction nozzle so that its bottom dead center is not too low.

- When positioning grippers wear out, they apply mechanical impact to part of the varistor when positioning it, thus chipping or cracking the varistor in some cases. Maintain the proper dimensions of the positioning grippers in their closed state and regularly carry out maintenance, check, or replacement of the positioning grippers.
- A varistor mounted on a heavily warped printed board, may crack or break. Put a backup pin on the back of the board to reduce the warp of the board to 0.5 mm or less with 90 mm span width.

## &lt;Selecting flux&gt;

- Flux may have a great effect on the performance of the varistor. Before using the varistor, check whether the flux has any effect on the performance of the varistor.

## &lt;Soldering&gt;

- Flow soldering

In the flow soldering process, stress created by a sharp temperature change is applied directly to the varistor. Be careful, particularly, in controlling the solder temperature. The varistor is particularly vulnerable to rapid heating and rapid cooling. When heated or cooled rapidly, the varistor develops excessive heat stress therein resulting from the large temperature difference and because of this heat stress, may thermally crack. Observe the following instructions on preheating, gradual cooling, etc.

- (1) Applying flux : Apply a thin and uniform film of flux to the varistor. In the flow soldering process, flux application by a foaming method is generally adopted.
- (2) Preheating : Preheat the varistor sufficiently so that the difference between the solder temperature and the surface temperature of the varistor is 150 °C or less.
- (3) Immersion in solder : Immerse the varistor in melted solder of 240 °C to 260 °C in a solder bath for 3 to 5 seconds.
- (4) Gradual cooling : Avoid rapidly cooling (forced cooling) the soldered varistor, instead cool it gradually. Rapidly cooling the varistor may result in thermal cracking of the varistor.
- (5) Cleaning : When dipping the varistor in a cleaning solution right after soldering the varistor, confirm that the surface temperature of the varistor is 100 °C or lower.

(6) There is no problem with one cycle of flow soldering under the recommended flow soldering profile (example) conditions shown in the following diagram.

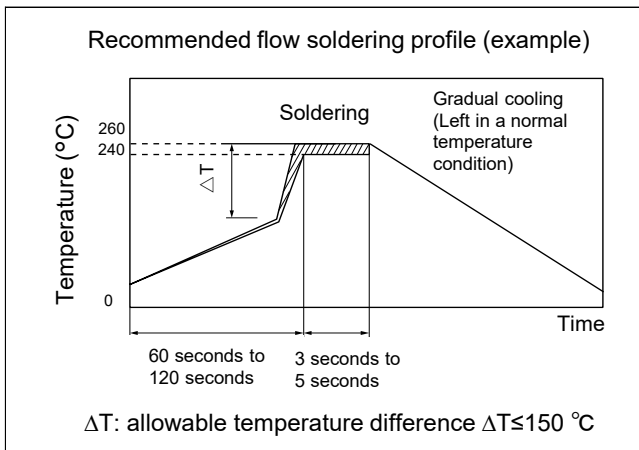

Size	Allowable temperature difference
1608	$T \leq 150^\circ\text{C}$

\* Avoid flow soldering varistors whose specifications are defined separately.

• Reflow soldering

A temperature condition under which reflow soldering is performed is represented by a temperature curve consisting of a preheating part, a temperature-rising part, a main heating part, and a gradual cooling part. Heating the varistor rapidly creates excessive heat stress therein due to a large temperature difference and, because of this heat stress, the varistor may thermally crack. Be sufficiently careful with a temperature difference resulting from rapid heating. The preheating part is a temperature area that is important for preventing a tombstone (chip rising) phenomenon. Be sufficiently careful with temperature control.

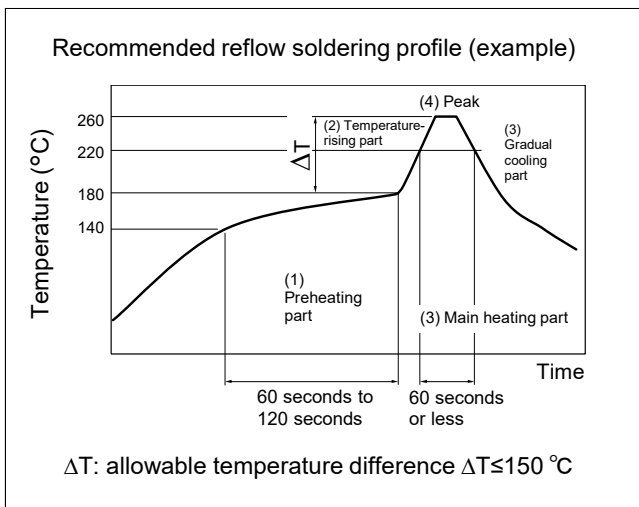

Items	Temperature condition	Time, heating rate
(1) Preheating part	140 °C to 180 °C	60 to 120 seconds
(2) Temperature-rising part	Preheating temperature to peak temperature	2 to 5 °C per second
(3) Main heating part	220 °C or higher	60 seconds or less
(4) Peak	260 °C or less	10 seconds or less
(5) Gradual cooling part	Peak temperature to 140 °C	1 to 4 °C per second

Size	Allowable temperature difference
0603 to 2012	$T \leq 150^\circ\text{C}$

Avoid performing rapid cooling (forced cooling) during the gradual cooling part. Rapidly cooling the varistor may result in thermal cracking of the varistor. When dipping the varistor in the cleaning solution right after soldering the varistor, confirm that the surface temperature of the varistor is 100 °C or lower. There is no problem with two cycles of reflow soldering under the recommended reflow soldering profile (example) conditions shown in the above diagram. Be sufficiently careful with deflection or warping of the board.

Note that the recommended soldering conditions indicate conditions under which the degradation of the product characteristics does not occur but do not indicate conditions under which stable soldering can be performed. Check and set conditions under which stable soldering can be performed, on a case-by-case basis.

Varistor temperatures vary depending on the mounted state of the varistor. Make sure to confirm that the surface temperature of the varistor is within the specified temperature when the varistor is mounted and then use the varistor.

• Soldering-iron-used soldering

In soldering-iron soldering, stress created by a rapid temperature change is applied directly to the varistor. Be sufficiently careful in controlling the temperature of the soldering iron tip. Be careful not to let the soldering iron tip come in direct contact with the varistor or its terminal electrode.

The varistor is particularly vulnerable to rapid heating and rapid cooling. When heated or cooled rapidly, the varistor develops excessive heat stress therein resulting from the large temperature difference and because of this heat stress, may thermally crack. Observe the following instructions on preheating, gradual cooling, etc.

Once a varistor soldered with a soldering iron is removed from the board, it cannot be used again.

(1) Condition 1 (preheating included)

- (a) Solder: : Use wire solder (with less chloride content) that is meant for soldering precision electronic equipment. (Wire diameter: 1.0 mm or less)
- (b) Preheating: : Preheat the varistor sufficiently so that the difference between the solder temperature and the surface temperature of the varistor is 150°C or less.
- (c) Temperature of the soldering iron tip : 300°C or lower (a required volume of solder is melted on the soldering iron tip in advance).
- (d) Gradual cooling : After soldering the varistor, leave it in normal temperature conditions to let it cool gradually.

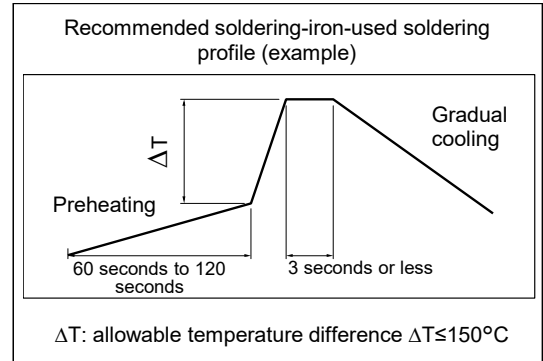

(2) Condition 2 (preheating not included)

If soldering iron tip conditions listed in the table on the right are met, the varistor can be soldered with the soldering iron without preheating the varistor.

- (a) Make sure that the soldering iron tip does not come in direct contact with the varistor or its terminal electrode.
- (b) After preheating the land sufficiently with the soldering-iron tip, slide the soldering-iron tip toward the terminal electrode of the varistor to solder the varistor.

Soldering iron tip conditions in soldering without preheating

Items	Condition
Temperature of the soldering iron tip	270 °C or lower
Wattage	20 W or less
Shape of the soldering iron tip	ø3 mm or less
Soldering-iron applying time	3 seconds or less

<Inspection>

• When the printed board is inspected with measurement terminal pins after the varistor is mounted on the board, the measurement terminal pins pressed against the printed board cause the board to warp, which may cause a crack to form on the varistor.

- (1) Put the backup pin on the back of the printed board to reduce the warp of the board to 0.5 mm or less with a 90 mm span width.
- (2) Check whether the shape of the front ends of the measurement terminal pins poses no problem, whether the pins are equal in length, whether the pressure of the pins are not excessively high, and whether the set position of the pins is correct.

Items	Case to avoid	Case recommended
Warp in the board	<p>Measurement terminal pin</p> <p>Peeling, cracking</p>	<p>Measurement terminal pin</p> <p>Backup pin</p>

<Protective coat>

• When the varistor is coated with or embedded in a resin to improve the varistor's resistance to humidity and gas or to set the varistor stationary, it is expected that the following problems will arise. In such cases, confirm the performance and reliability of the varistor in advance.

- (1) A solvent included in the resin infiltrates the varistor and impairs its characteristics.
- (2) Heat from chemical reaction (curing heat) generated by the resin when it cures exerts a negative effect on the varistor.
- (3) Expansion/shrinkage of the resin applies stress to the soldering part and causes it to crack.

<Splitting a multiple formation printed board>

- When splitting the board having components, including a mounted varistor into multiple pieces, be careful not to apply bending stress or torsional stress to the board. If bending stress or torsional stress, shown in the following diagram, is applied to the board when it is split, the varistor may develop a crack. Avoid, as much as possible, applying stress to the board.

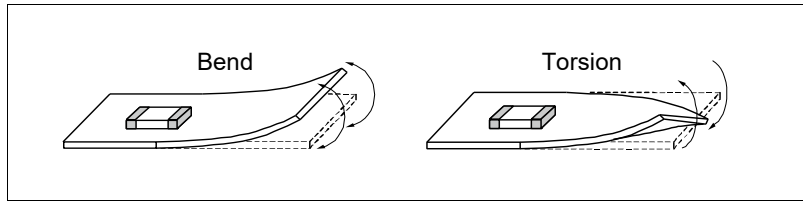

- Avoid manually splitting the board so as to keep mechanical stress to the board as small as possible. When splitting the board, use a splitting jig or a board splitter.
- Example of a board splitting jig  
An example of a board splitting jig is shown in the following diagram. Holding the part of the board that is far from the jig and applying a load bend the board excessively. Holding the part of the board that is closer to the jig and applying a load allow you to split the board with less bending.

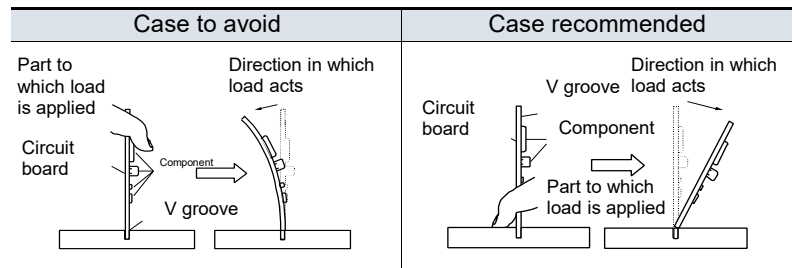
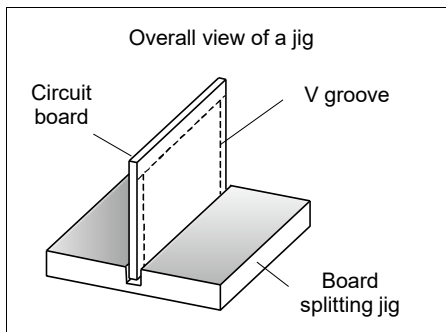

**Storage conditions**

- Avoid a high-temperature/high-humidity storage place and keep the varistor in a storage place where temperature ranges from 5 °C to 40 °C and relative humidity ranges from 20% to 70%.
- Do not store the varistor in a place where moisture, dust, or corrosive gas (hydrogen chloride, hydrogen sulfide, sulfur dioxide, ammonia, etc.) is present. It may impair the solderability of the terminal electrode. Also, in places where the varistor package is exposed to heat, direct sunlight, etc., packaging tape may deform or stick to the varistor which causes a problem when the varistor is mounted. Be careful in such cases.
- A varistor storage period shall be 12 months or less. When using a varistor kept in storage for more than 12 months, confirm its solderability before using it.

## Multilayer Varistor

For ESD pulse

Low capacitance type [High speed signal lines]

**EZJZ series**



### Features

- Ultra-low capacitance by our original materials and lamination technologies, supporting high-speed signal lines (applicable to interfaces such as USB2.0, IEEE1394, HDMI, etc.)
- Capacitance value : 0.8 to 2.1 pF typ.
- Excellent ESD suppression due to original advanced material technology
- Having large electrostatic resistance meeting IEC61000-4-2, Level 4 standard
- Having no polarity (bipolar) facilitated replacing Zener Diodes. Capable of replacing 2 Zener Diodes and 1 Capacitor.
- Lead-free plating terminal electrodes enabling great solderability
- Wide range of products is available by adopting multilayer structure, meeting various needs
- RoHS compliant

### Explanation of part numbers

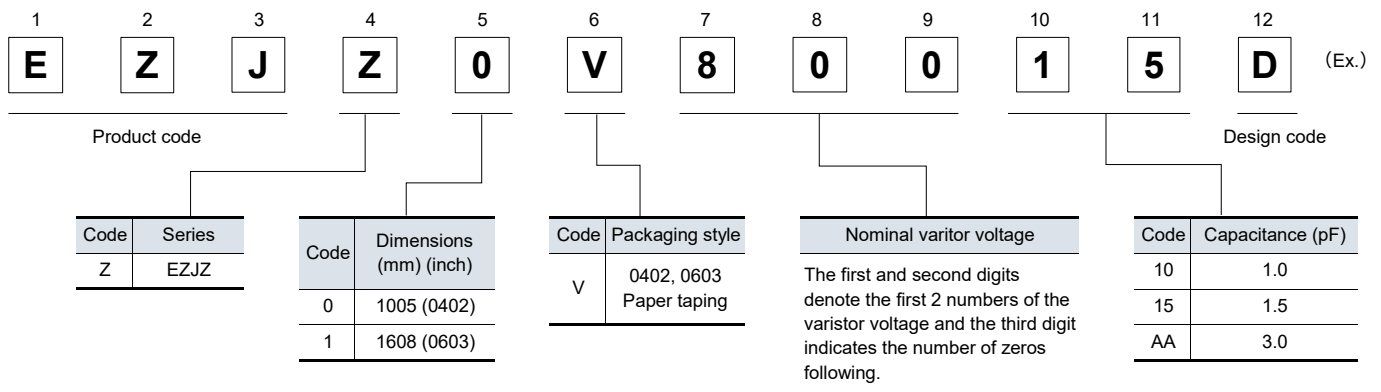

### Construction

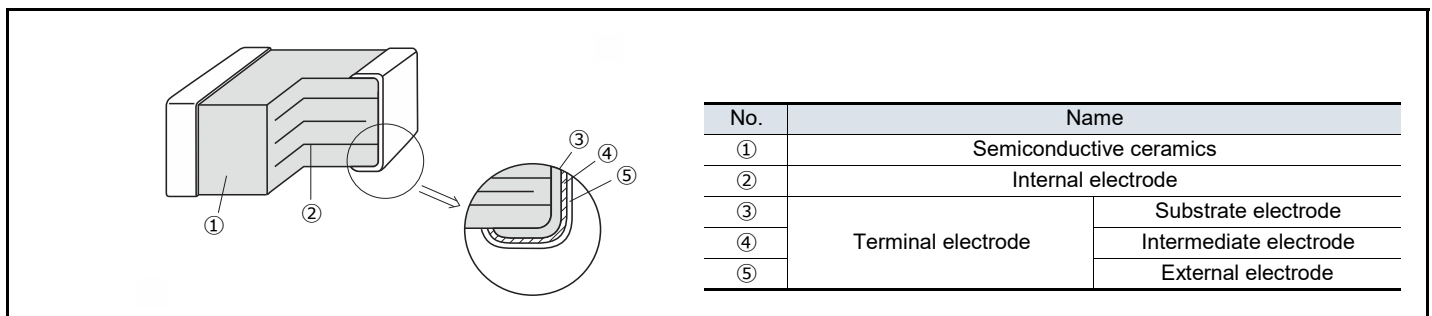

### Dimensions in mm (not to scale)

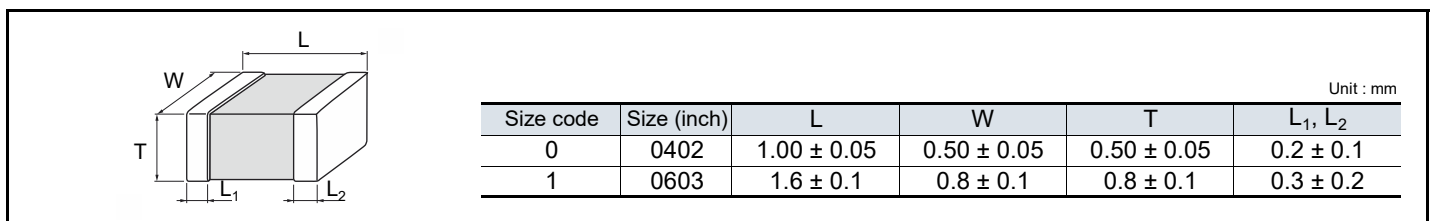

## EZJZ series / Low capacitance type [High speed signal lines]

### Recommended applications

Mobile phone	Antenna circuit, External IF
DSC,DVC	USB2.0, IEEE1394
PC,PDA	USB2.0, IEEE1394, LAN1000BASE
TV,DVD	USB2.0, IEEE1394, HDMI
Game console	Controller, External IF

### Ratings and characteristics

Size (inch)	Part No.	Maximum allowable voltage DC (V)	Nominal varistor voltage at 1 mA (V)	Capacitance at 1 MHz (pF)	Maximum ESD IEC61000-4-2
0402	EZJZ0V80010	10	80	1 max. [0.8 typ.]	Contact discharge : 8 kV
	EZJZ0V80015D	5	80	1.5±0.5	
	EZJZ0V500AA	5	50	3 max. [2.1 typ.]	
	EZJZ0V800AA	18	80	3 max. [2.1 typ.]	
	EZJZ0V171AA	18	170	3 max. [2.1 typ.]	
0603	EZJZ1V80010	10	80	1 max. [0.8 typ.]	
	EZJZ1V500AA	5	50	3 max. [2.1 typ.]	
	EZJZ1V800AA	18	80	3 max. [2.1 typ.]	
	EZJZ1V171AA	18	170	3 max. [2.1 typ.]	

● Operating temperature range : -40 to 85 °C

\* Recommend soldering method : Reflow soldering

### Voltage and current characteristics

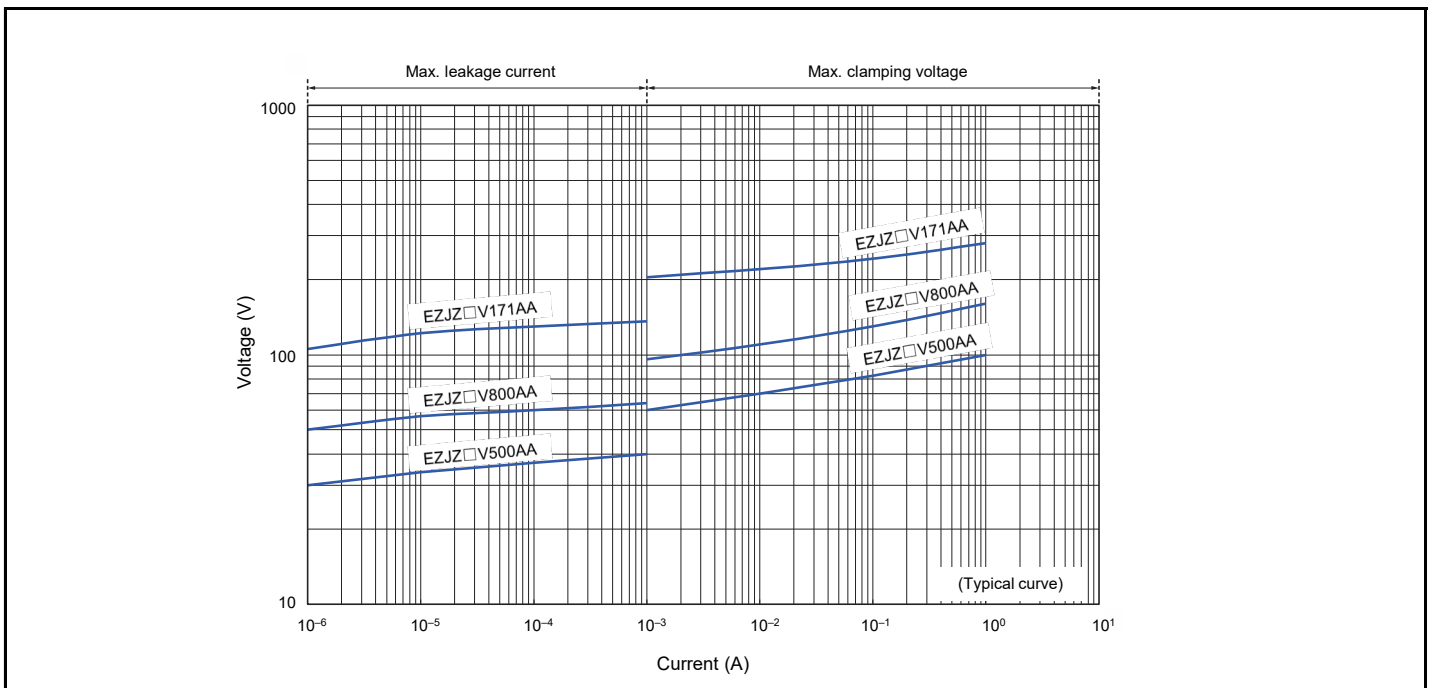

Frequency - Capacitance

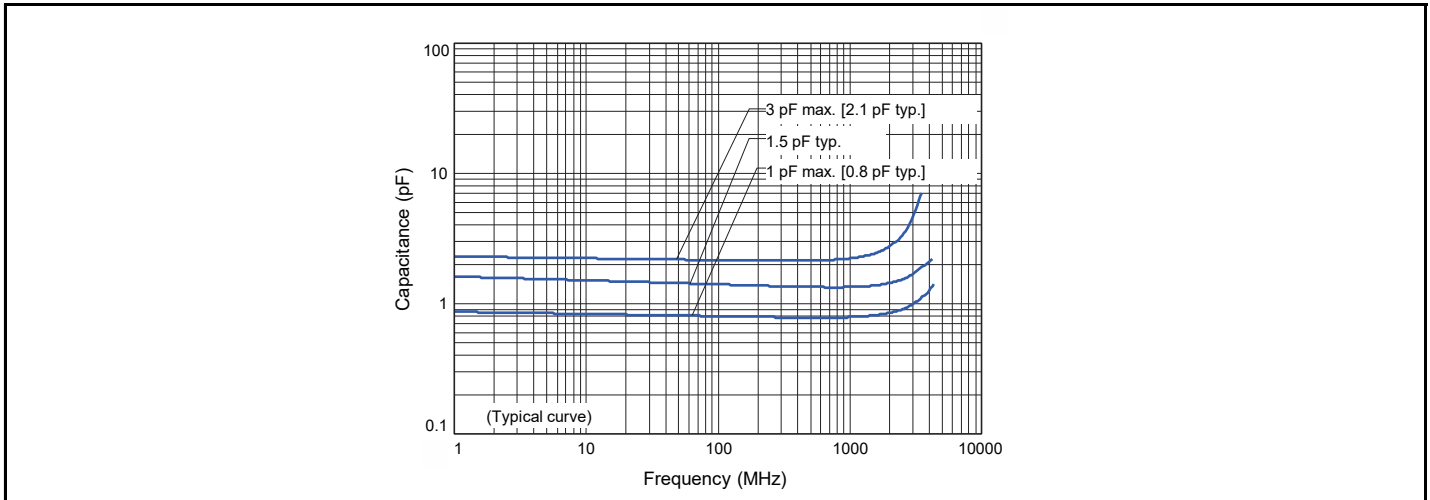

Frequency - Impedance

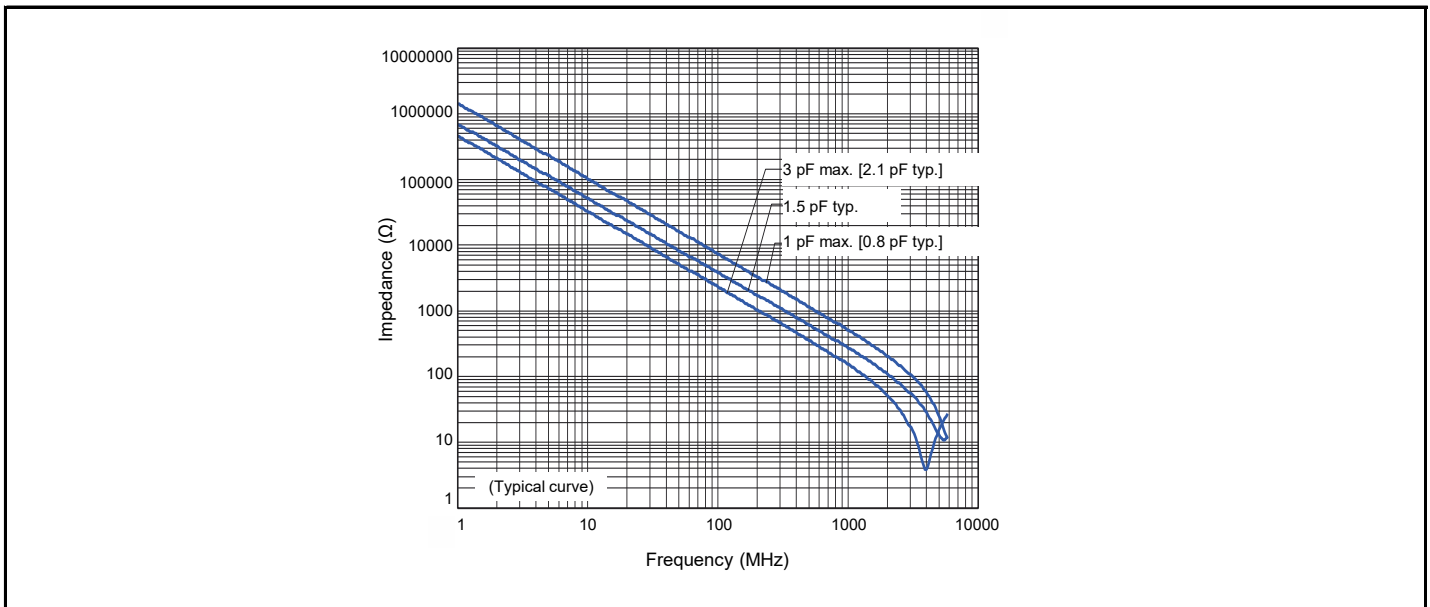

Frequency - Attenuation

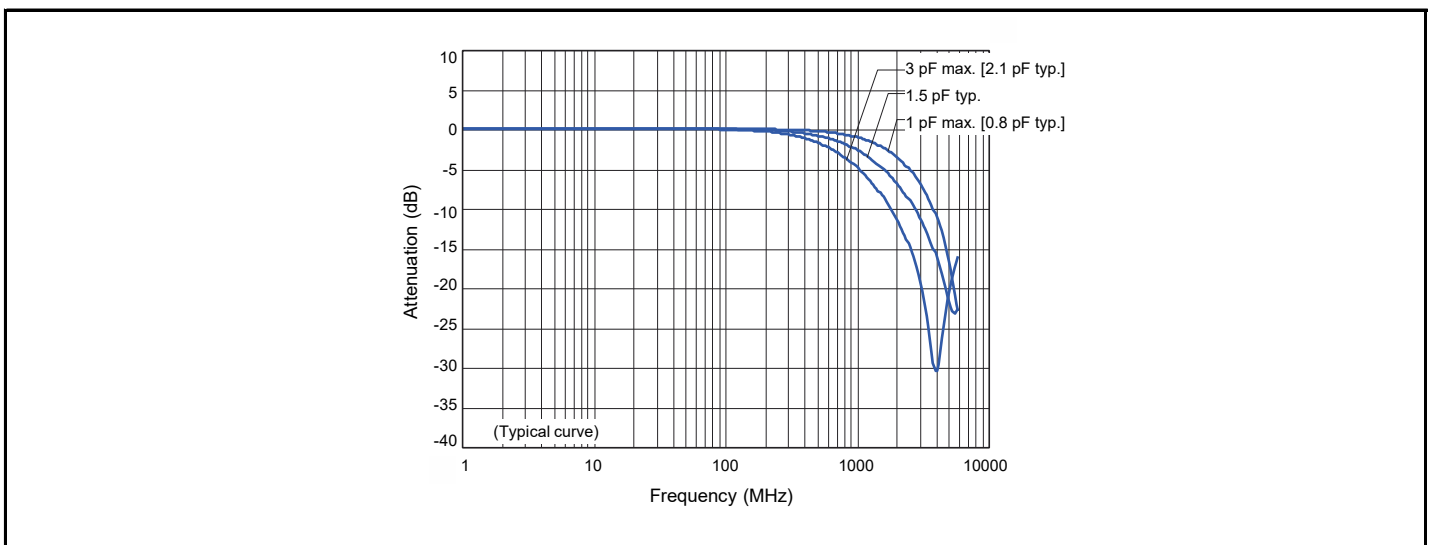

■ As for packaging methods, handling precautions please see data files

## Multilayer Varistor

For ESD pulse and surge protection

Low voltage type (Standard type)

[DC voltage lines/Low speed signal lines]

**EZJZ** series

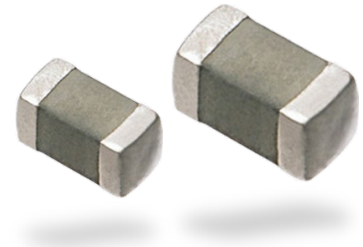

### Features

- Excellent ESD and surge suppression effects due to original advanced material technology
- Having large electrostatic resistance meeting IEC61000-4-2, Level 4 standard
- Having no polarity (bipolar) facilitated replacing Zener Diodes. Capable of replacing 2 Zener Diodes and 1 Capacitor.
- Lead-free plating terminal electrodes enabling great solderability
- Wide range of products is available by adopting multilayer structure, meeting various needs  
(Applicable to a wide range of applications from DC voltage lines to signal circuits)
  - Varistor voltage: 18 to 65 V (at 1 mA)
  - Capacitance : 15 to 180 pF typ. (at 1 MHz)

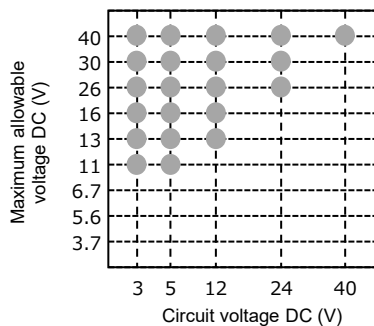

- RoHS compliant

### Explanation of part numbers

1	2	3	4	5	6	7	8	9	10	11	12	Example
<b>E</b>	<b>Z</b>	<b>J</b>	<b>Z</b>	<b>0</b>	<b>V</b>	<b>4</b>	<b>7</b>	<b>0</b>	<b>W</b>	<b>A</b>		
Product code					Design code							

Code	Series	Code	Dimensions (mm) (inch)	Code	Packaging style	Nominal varistor voltage				Code	Design code				
Z	EZJZ	0	1005 (0402)	V	0402, 0603 Paper taping	The first and second digits denote the first 2 numbers of the varistor voltage and the third digit indicates the number of zeros following. The decimal point denotes in R.				A	Nil				
		1	1608 (0603)							A	3	G	100	B	Cap.Tolerance : ± 0.1 pF
										R	20	H	150	C	Cap.Tolerance : ± 0.25 pF
										D	27	J	220	D	Cap.Tolerance : ± 0.50 pF
										E	47	K	330	K	Cap.Tolerance : ± 10 %
										W	56	M	680	M	Cap.Tolerance : ± 20 %
						F	68								

### Construction

No.	Name
①	Semiconductive ceramics
②	Internal electrode
③	Substrate electrode
④	Intermediate electrode
⑤	External electrode

## EZJZ series / Low voltage type (Standard type) [DC voltage lines/Low speed signal lines]

### Dimensions in mm (not to scale)

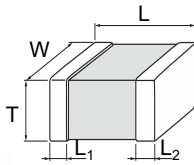

Unit : mm					
Size code	Size (inch)	L	W	T	L <sub>1</sub> , L <sub>2</sub>
0	0402	1.00 ± 0.05	0.50 ± 0.05	0.50 ± 0.05	0.2 ± 0.1
1	0603	1.6 ± 0.1	0.8 ± 0.1	0.8 ± 0.1	0.3 ± 0.2

### Recommended applications

Mobile phone	SW, LCD, LED, Audio terminal, Battery pack, Memory card, External IF
DSC,DVC	SW, LCD, LED, USB
PC,PDA	SW, LCD, LED, USB
TV,DVD	Audio, Video terminal
Audio	Audio terminal, Microphone, Receiver
Game console	Controller, External IF

### Ratings and characteristics

Size (inch)	Part No.	Maximum allowable voltage DC (V)	Nominal varistor voltage at 1 mA (V)	Capacitance (pF)		Maximum peak current at 8/20 μs, 2 times (A)	Maximum ESD IEC61000-4-2
				at 1 MHz	at 1 kHz		
0402	EZJZ0V180HA	11	18	150 max. [120 typ.]	140 typ.	10	Contact discharge :8 kV
	EZJZ0V220HA	13	22	150 max. [100 typ.]	116 typ.	10	
	EZJZ0V270EA	16	27	47 max. [33 typ.]	37 typ.	10	
	EZJZ0V270RA	16	27	20 max. [15 typ.]	16.5 typ.	3	
	EZJZ0V420WA	30	42	56 max. [40 typ.]	45 typ.	10	
	EZJZ0V650DA	40	65	27 max. [22 typ.]	33 typ.	5	
0603	EZJZ1V180JA	11	18	220 max. [180 typ.]	210 typ.	20	
	EZJZ1V220JA	13	22	220 max. [160 typ.]	185 typ.	20	
	EZJZ1V270GA	16	27	100 max. [85 typ.]	100 typ.	20	
	EZJZ1V270EA	16	27	47 max. [33 typ.]	37 typ.	20	
	EZJZ1V270RA	16	27	20 max. [15 typ.]	16.5 typ.	3	
	EZJZ1V330GA	26	33	100 max. [85 typ.]	100 typ.	20	
	EZJZ1V420FA	30	42	68 max. [55 typ.]	63 typ.	15	
	EZJZ1V650DA	40	65	27 max. [22 typ.]	33 typ.	5	

● Operating Temperature Range : -40 to 85 °C

\* Recommend soldering method : Reflow soldering

[term]

Maximum allowable voltage	Maximum DC Voltage that can be applied continuously within the operating temperature range
Varistor voltage	Varistor starting voltage between terminals at DC 1 mA, also known as Breakdown voltage
Maximum peak current	Maximum current that can be withstood under the standard pulse 8/20 μs, 2 times based
Maximum ESD	Maximum voltage that can be withstood under ESD based on IEC61000-4-2, 10 times (5 times of each positive-negative polarity)

**Voltage and current characteristics**

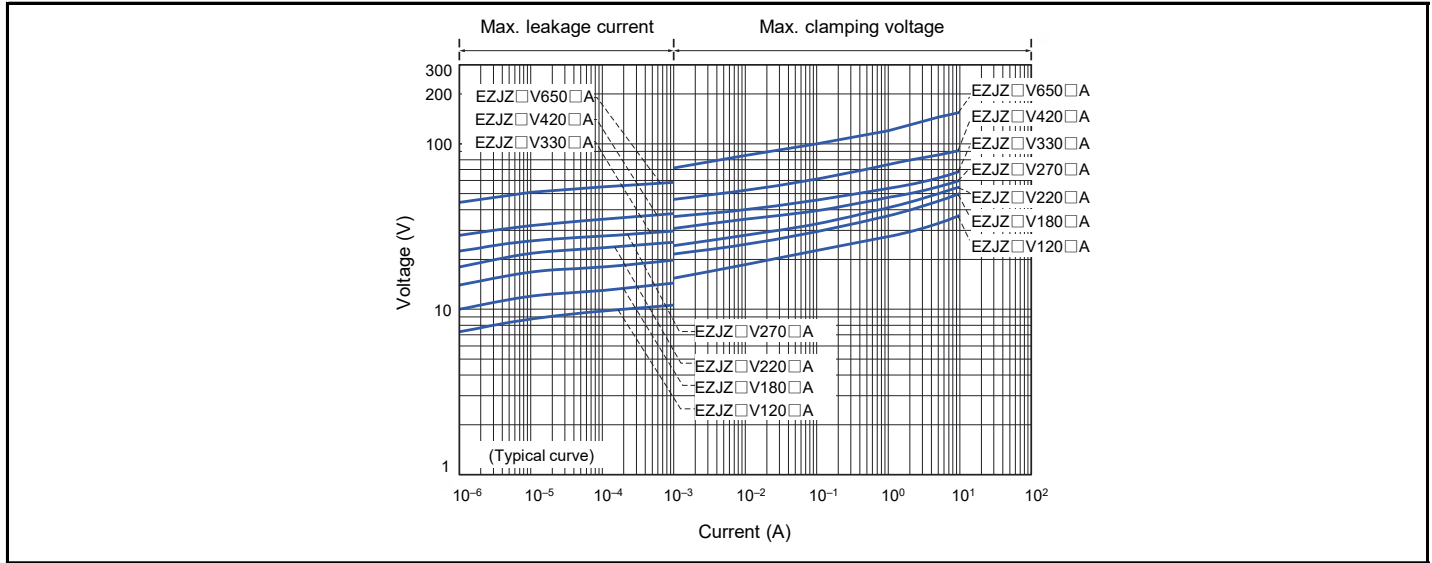

**Capacitance - Frequency**

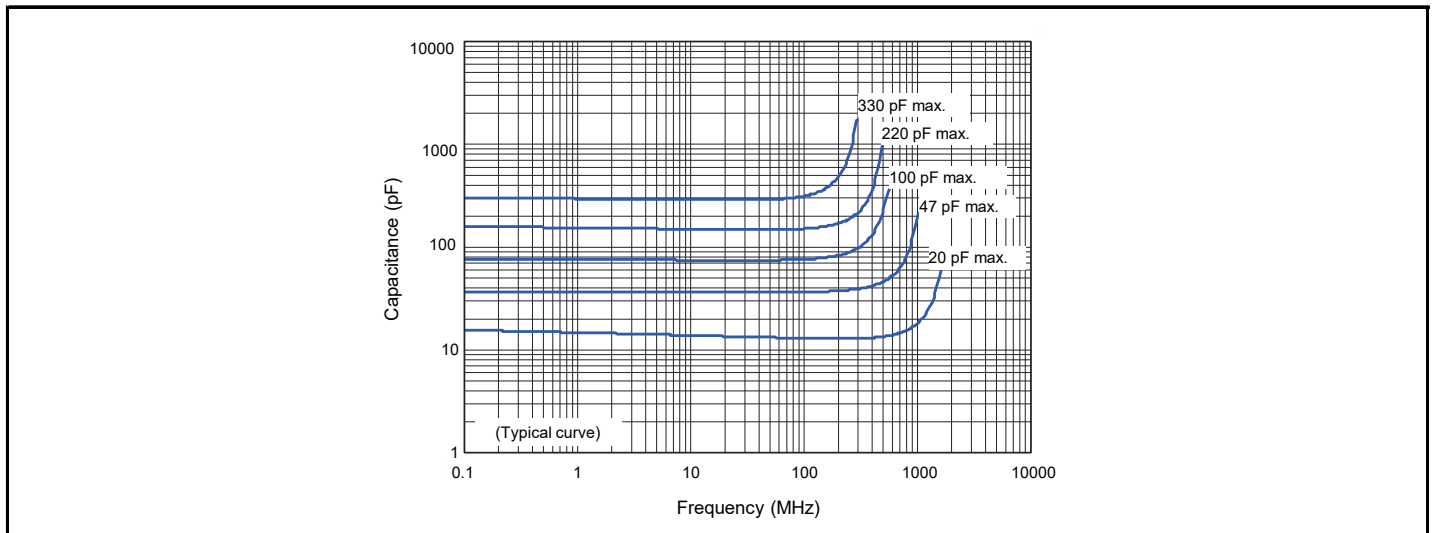

**Attenuation - Frequency**

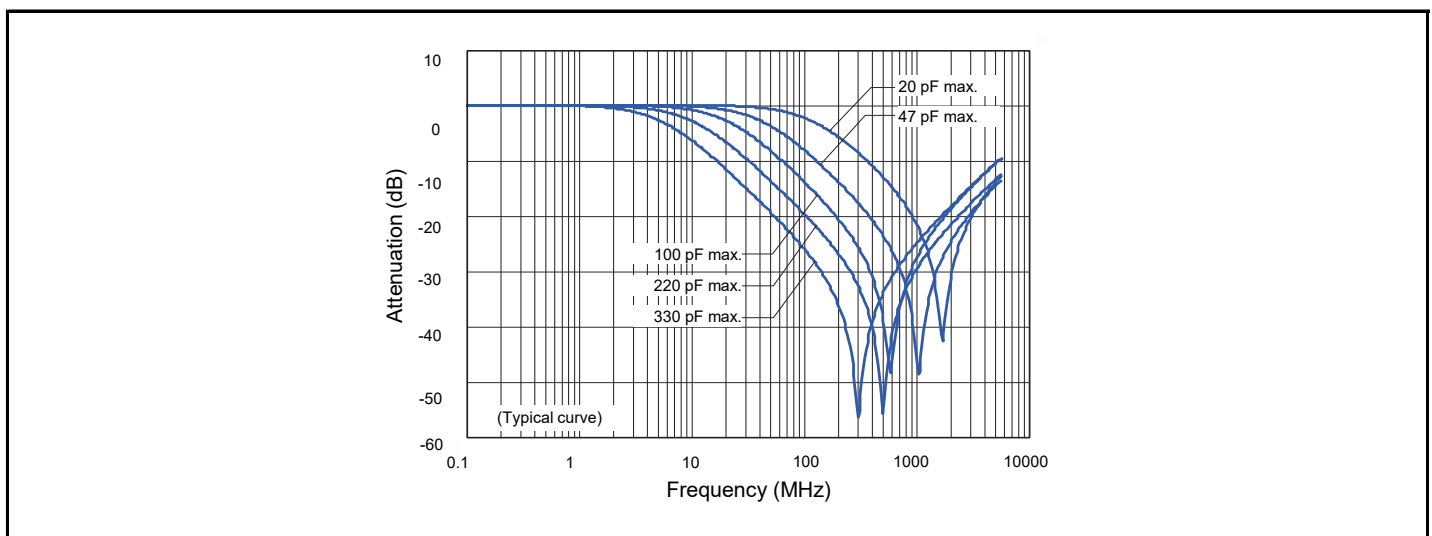

■ As for packaging methods, handling precautions please see data files

## Multilayer Varistor

For ESD pulse

Low voltage type (Standard type)

[DC voltage lines / Low speed signal lines]

**EZJP** series



### Features

- Excellent ESD suppression effects due to original advanced material technology
- Having large electrostatic resistance meeting IEC61000-4-2, Level 4 standard
- Having no polarity (bipolar) facilitated replacing Zener Diodes. Capable of replacing 2 Zener Diodes and 1 Capacitor.
- Lead-free plating terminal electrodes enabling great solderability
- Wide range of products is available by adopting multilayer structure, meeting various needs  
(Applicable to a wide range of applications from DC voltage lines to signal circuits)

· Varistor voltage: 6.8 to 65 V (at 1 mA)

· Capacitance :8.5 to 420 pF typ. (at 1 MHz)

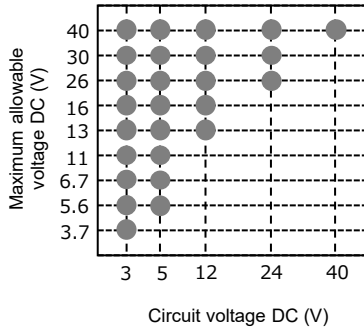

- RoHS compliant

### Explanation of part numbers

1	2	3	4	5	6	7	8	9	10	11	12	(Ex.)
<b>E</b>	<b>Z</b>	<b>J</b>	<b>P</b>	<b>0</b>	<b>V</b>	<b>2</b>	<b>7</b>	<b>0</b>	<b>E</b>	<b>A</b>		
Product code						Design code						

Code	Series	Code	Dimensions (mm) (inch)	Code	Packaging style	Nominal varistor voltage	Code	Cap. (pF)	Code	Cap. (pF)	Code	Design code
P	EZJP	Z	0603 (0201)	V	0402, 0603 Paper taping	The first and second digits denote the first 2 numbers of the varistor voltage and the third digit indicates the number of zeros following. The decimal point denotes in R.	A	3	G	100	Nil	Cap.Tolerance : max.
		0	1005 (0402)				R	20	H	150	B	Cap.Tolerance : ± 0.1 pF
		1	1608 (0603)				D	27	J	220	C	Cap.Tolerance : ± 0.25 pF
							E	47	K	330	D	Cap.Tolerance : ± 0.50 pF
							W	56	M	680	K	Cap.Tolerance : ± 10 %
							F	68			M	Cap.Tolerance : ± 20 %

### Construction

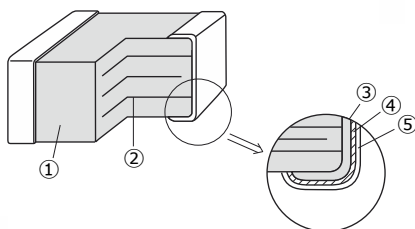

No.	Name
①	Semiconductive ceramics
②	Internal electrode
③	Substrate electrode
④	Intermediate electrode
⑤	External electrode

# EZJP series / Low voltage type (Standard type) [DC voltage lines / Low speed signal lines]

## Dimensions in mm (not to scale)

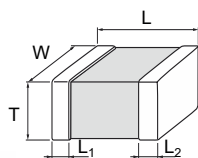

Unit : mm					
Size code	Size (inch)	L	W	T	L <sub>1</sub> , L <sub>2</sub>
Z	0201	0.60 ± 0.03	0.30 ± 0.03	0.30 ± 0.03	0.15 ± 0.05
0	0402	1.00 ± 0.05	0.50 ± 0.05	0.50 ± 0.05	0.2 ± 0.1
1	0603	1.6 ± 0.1	0.8 ± 0.1	0.8 ± 0.1	0.3 ± 0.2

## Recommended applications

Mobile phone	SW, LCD, LED, Audio terminal, Battery pack, Memory card, External IF
DSC,DVC	SW, LCD, LED, USB
PC,PDA	SW, LCD, LED, USB
TV,DVD	Audio, Video terminal
Audio	Audio terminal, Microphone, Receiver
Game console	Controller, External IF

## Ratings and characteristics

Size (inch)	Part No.	Maximum allowable voltage DC (V)	Nominal varistor voltage at 1 mA (V)	Capacitance (pF) [typ. Reference value]		Maximum peak current at 8/20 μs, 2 times (A)	Maximum ESD IEC61000-4-2
				at 1 MHz	at 1 kHz		
0201	EZJPZV6R8JA	3.7	6.8	220 max. [150 typ.]	175 typ.	5	Contact discharge :8 kV
	EZJPZV6R8GA	3.7	6.8	100 max. [85 typ.]	100 typ.	5	
	EZJPZV080GA	5.6	8	100 max. [85 typ.]	100 typ.	5	
	EZJPZV120GA	7.5	12	100 max. [85 typ.]	100 typ.	5	
	EZJPZV120DA	7.5	12	27 max. [22 typ.]	33 typ.	1	
	EZJPZV120RA	7.5	12	20 max. [15 typ.]	18 typ.	1	
	EZJPZV150RA	9	15	20 max. [15 typ.]	18 typ.	1	
	EZJPZV270RA	16	27	20 max. [15 typ.]	16.5 typ.	1	
0402	EZJPZV270BA	16	27	10 max. [8.5 typ.]	10 typ.	1	
	EZJP0V6R8MA	3.7	6.8	680 max. [420 typ.]	650 typ.	20	
	EZJP0V6R8GA	3.7	6.8	100 max. [85 typ.]	100 typ.	3	
	EZJP0V080MA	5.6	8	680 max. [420 typ.]	650 typ.	20	
	EZJP0V080KA	5.6	8	330 max. [290 typ.]	480 typ.	15	
	EZJP0V080GA	5.6	8	100 max. [65 typ.]	100 typ.	3	
	EZJP0V080DA	5.6	8	27 max. [22 typ.]	33 typ.	1	
	EZJP0V120JA	7.5	12	220 max. [150 typ.]	175 typ.	10	
	EZJP0V180HA	11	18	150 max. [120 typ.]	140 typ.	10	
	EZJP0V220HA	13	22	150 max. [100 typ.]	116 typ.	10	
	EZJP0V270GA	16	27	100 max. [85 typ.]	100 typ.	10	
	EZJP0V270EA	16	27	47 max. [33 typ.]	37 typ.	4	
	EZJP0V270RA	16	27	20 max. [15 typ.]	16.5 typ.	1	
	EZJP0V270BA	16	27	10 max. [8 typ.]	10 typ.	—	
	EZJP0V330GA	25	33	100 max. [85 typ.]	100 typ.	10	
	0603	EZJP0V420WA	30	42	56 max. [40 typ.]	45 typ.	
EZJP0V650DA		40	65	27 max. [22 typ.]	33 typ.	2	
EZJP0V101BA		30	100	10 max. [8 typ.]	10 typ.	—	
EZJP1V120KA		7.5	12	330 max. [250 typ.]	290 typ.	20	
EZJP1V180JA		11	18	220 max. [180 typ.]	210 typ.	20	
EZJP1V270GA		16	27	100 max. [85 typ.]	100 typ.	10	
EZJP1V270EA		16	27	47 max. [33 typ.]	37 typ.	5	
EZJP1V270RA		16	27	20 max. [15 typ.]	16.5 typ.	2	
EZJP1V330GA		25	33	100 max. [85 typ.]	100 typ.	10	
EZJP1V420FA		30	42	68 max. [55 typ.]	63 typ.	10	
EZJP1V650DA	40	65	27 max. [22 typ.]	33 typ.	6		

● Operating temperature range : -40 to 85 °C

\* Recommend soldering method : Reflow soldering

[term]

Maximum allowable voltage	Maximum DC Voltage that can be applied continuously within the operating temperature range
Varistor voltage	Varistor starting voltage between terminals at DC 1 mA, also known as Breakdown voltage
Maximum peak current	Maximum current that can be withstood under the standard pulse 8/20 μs, 2 times based
Maximum ESD	Maximum voltage that can be withstood under ESD based on IEC61000-4-2, 10 times (5 times of each positive-negative polarity)

Design and specifications are each subject to change without notice. Ask factory for the current technical specifications before purchase and/or use. Should a safety concern arise regarding this product, please be sure to contact us immediately.

1-Aug-25

# EZJP series / Low voltage type (Standard type) [DC voltage lines / Low speed signal lines]

## Voltage and current characteristics

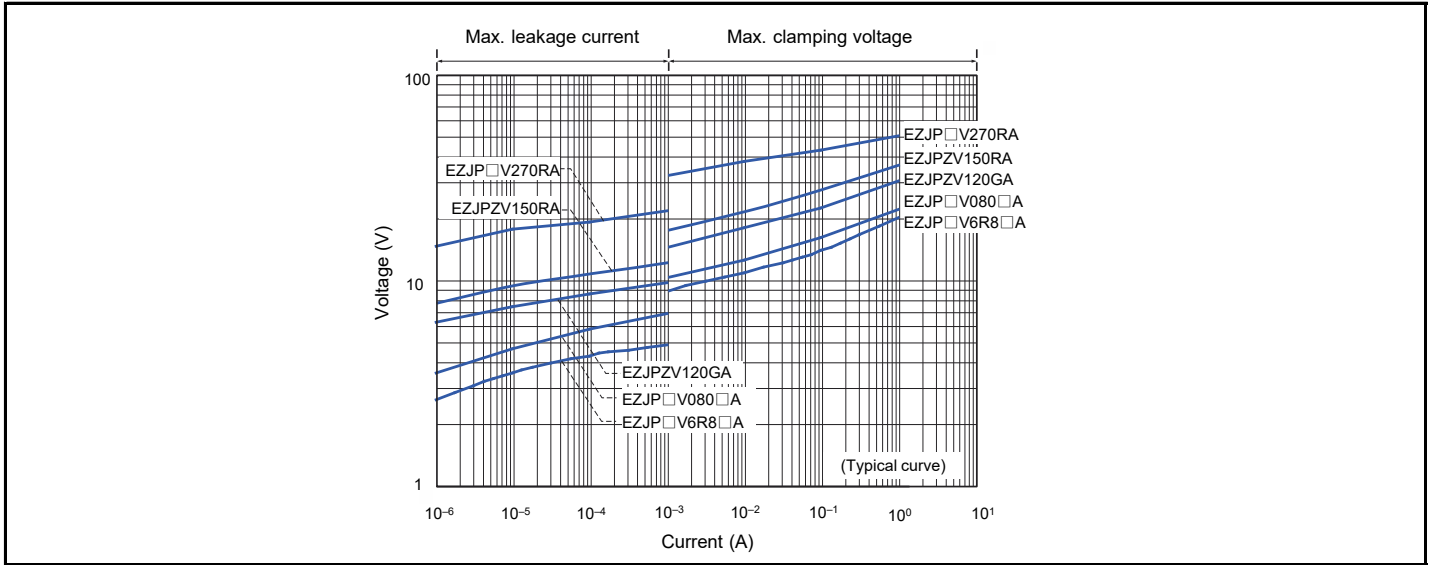

## Capacitance - Frequency

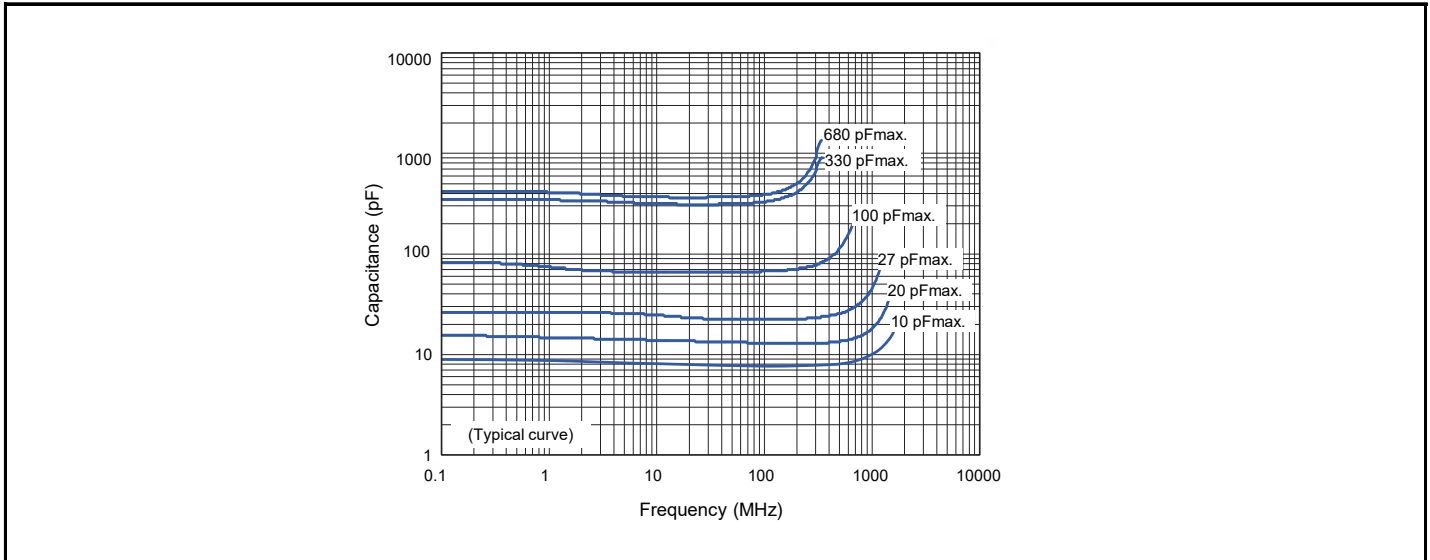

## Attenuation - Frequency

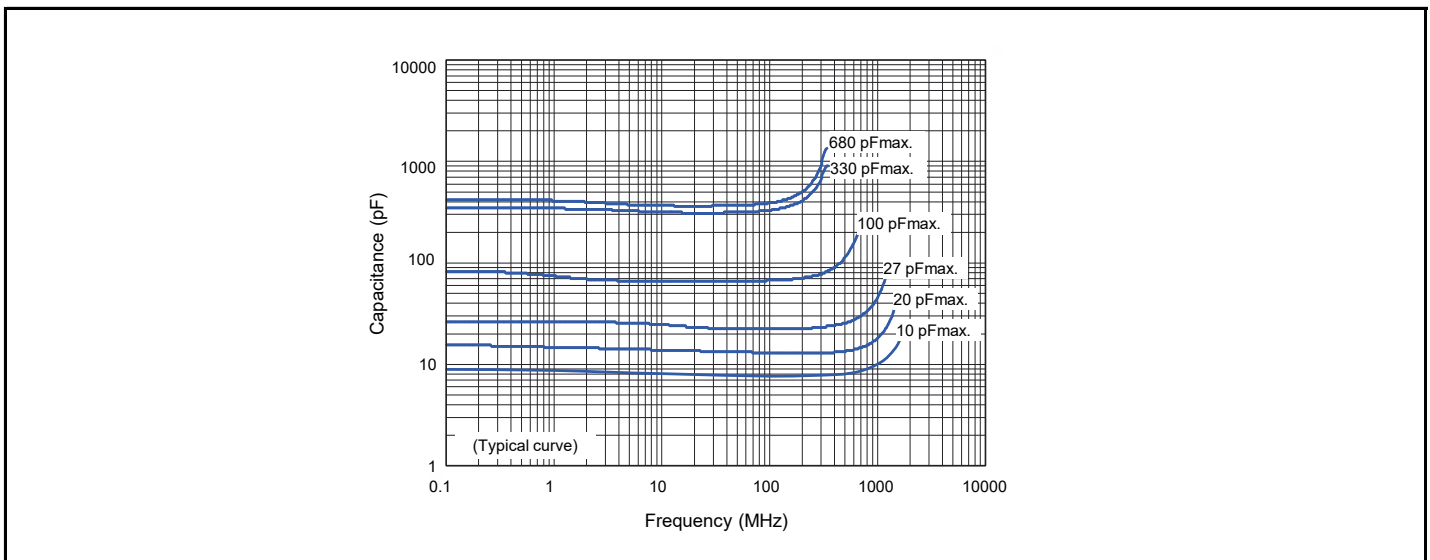

■ As for packaging methods, handling precautions please see data files

## Multilayer Varistor

For ESD pulse [DC voltage lines]

### EZJS series



#### Features

- Excellent ESD suppression due to original advanced material technology
- Having large electrostatic resistance meeting IEC61000-4-2, Special Level 30 kV standard
- Having no polarity (bipolar) facilitated replacing Zener Diodes. Capable of replacing 2 Zener Diodes and 1 Capacitor.
- Lead-free plating terminal electrodes enabling great solderability
- RoHS compliant

#### Explanation of part numbers

1	2	3	4	5	6	7	8	9	10	11	12	
<b>E</b>	<b>Z</b>	<b>J</b>	<b>S</b>	<b>2</b>	<b>Y</b>	<b>D</b>	<b>4</b>	<b>7</b>	<b>2</b>			Example
Product code			Series code			Nominal varistor voltage			Design code			

Code	Dimensions (mm) (inch)	Code	Packaging style code	Code	Max. allowable voltage code		Nominal varistor voltage
1	1608 (0603)	V	∅ 180 reel, Paper taping	B	DC 6 V	The first and second digits denote the first 2 numbers of the varistor voltage and the third digit indicates the number of zeros following.	
2	2012 (0805)	Y	∅ 180 reel, Embossed taping	C	DC 18 V		
				D	DC 30 V		

#### Construction

No.	Name
①	Semiconductive Ceramics
②	Internal electrode
③	Substrate electrode
④	Intermediate electrode
⑤	External electrode

#### Dimensions in mm (not to scale)

Size code	Size (inch)	L	W	T	L <sub>1</sub> , L <sub>2</sub>
1	0603	1.60 ± 0.15	0.8 ± 0.1	0.8 ± 0.1	0.3 ± 0.2
2	0805	2.0 ± 0.2	1.25 ± 0.20	0.8 ± 0.2 1.25 ± 0.20	0.50 ± 0.25

Unit : mm

**Ratings and Characteristics**

Size (inch)	Part No.	Maximum allowable voltage DC (V)	Nominal varistor voltage at 0.1 mA (V)	Capacitance at 1 kHz (pF)	Maximum ESD IEC61000-4-2
0603	EZJS1VB822	6	12	8200 typ.	Contact discharge : 30 kV
	EZJS1VC392	18	30	3900 typ.	
	EZJS1VD182	30	50	1800 typ.	
0805	EZJS2VB223	6	12	22000 typ.	
	EZJS2YC822	18	30	8200 typ.	
	EZJS2YD472	30	50	4700 typ.	

● Operating Temperature Range : -40 to 85 °C

\* Avoid flow soldering.

**Voltage vs. Current**

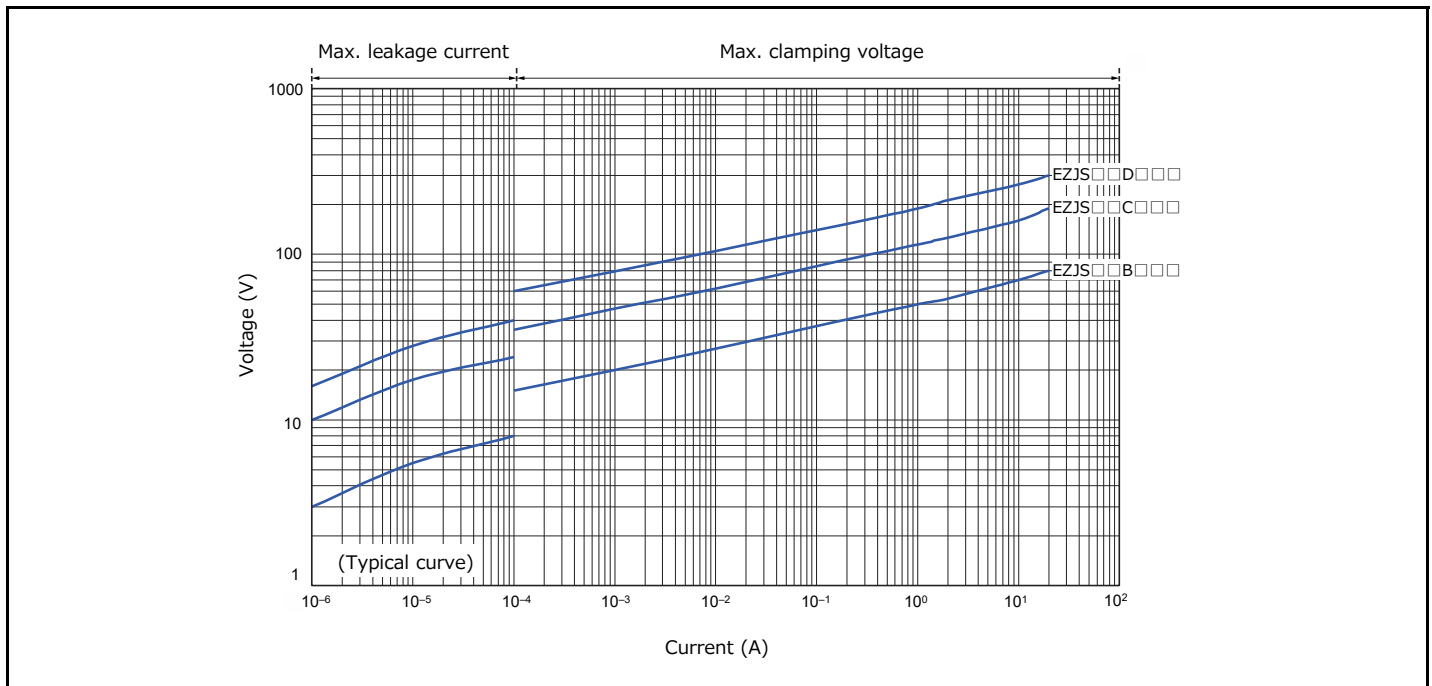

**Capacitance vs. Frequency**

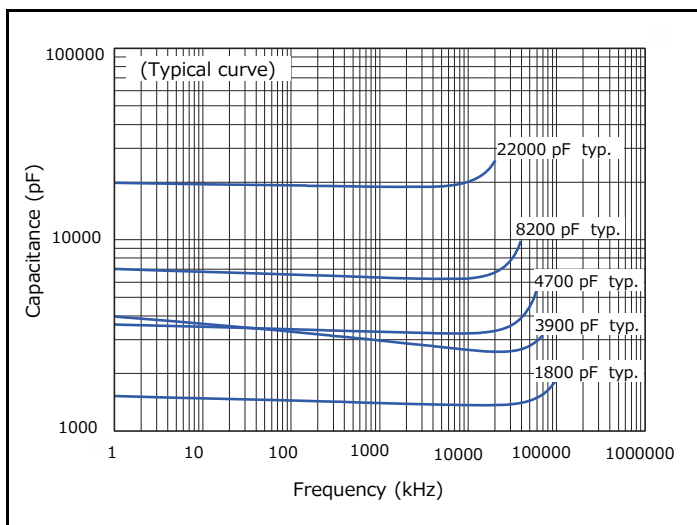

**Attenuation vs. Frequency**

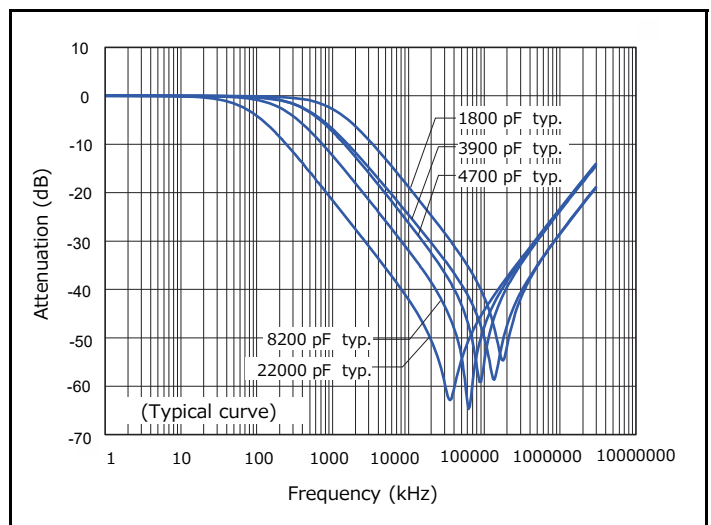

■ As for packaging methods, handling precautions please see data files

## Varistor characteristics and equivalent circuit

A Multilayer Varistor does not have an electrical polarity like zener diodes and is equivalent to total 3 pcs of 2 zener diodes and 1 capacitor.

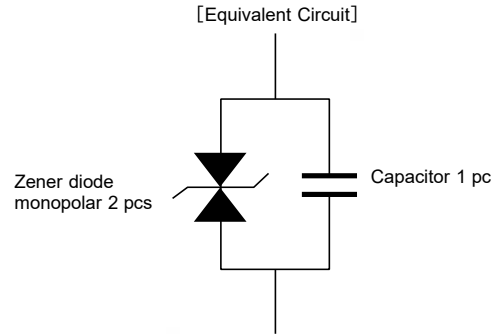
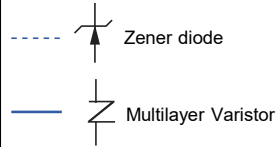
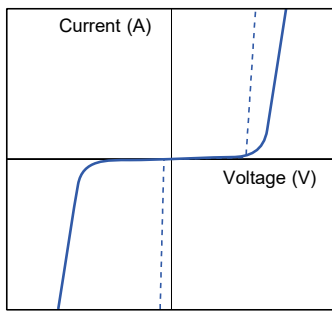

## ESD Suppressive effects

Typical effects of ESD suppression

Test conditions :

IEC61000-4-2\* Level4 Contact discharge, 8 kV

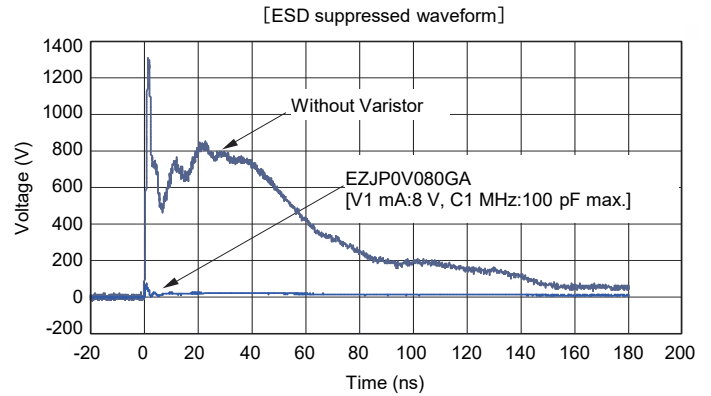
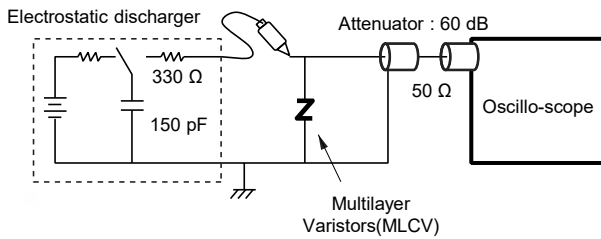

\*IEC61000-4-2 ... International Standard of the ESD testing method (HBM) for electronic equipment ability to withstand ESD generated from a human body. It sets 4 levels of severity

Severity	Level 1	Level 2	Level 3	Level 4
Contact discharge	2 kV	4 kV	6 kV	8 kV
Air discharge	2 kV	4 kV	8 kV	15 kV

## Replacement of zener diode

Replacing "Zener diode and Capacitor" with Multilayer Varistor saves both the mounting area and number of components used.

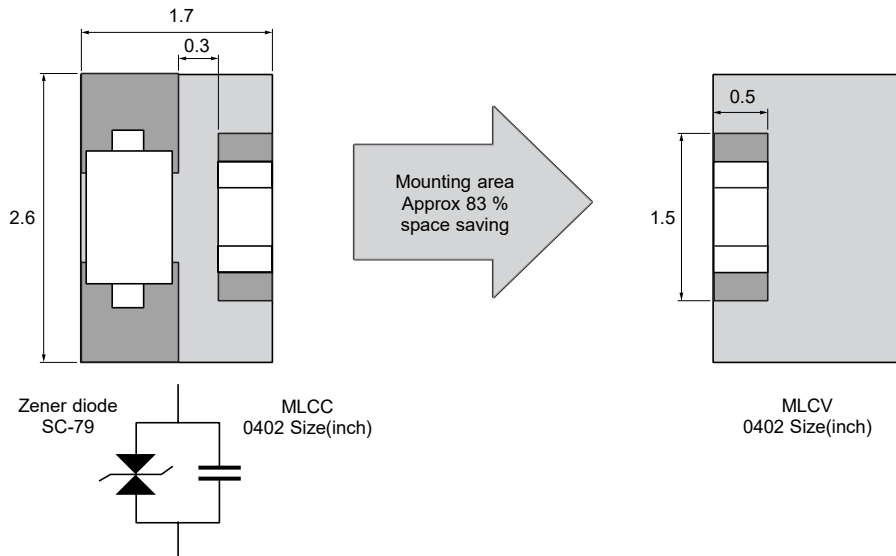

Unit : mm

## Recommended applications

Applications	Series	Circuit				
		DC	1k	1M	1G (Hz)	
Mobile phones, DSC, PC, PDA, HDD TV(PDP, LC etc.), DVD, DVC, Game consoles, Audio equipment	EZJZ, EZJP	Ultra low capacitance (Cap. : 3 pF or less)				DC to GHz Antenna, RF circuit, LVDS, USB, IEEE1394, HDMI etc.
		Low capacitance (Cap. : 20 to 680 pF)				DC to tens of Hz PWR, SW, Audio terminals LCD, RS232C, etc.
PWR, Photoelectric sensors, SSR, Motors, Pressure sensors, Proximity switches	EZJS	High capacitance (Cap. : 1800 to 22000 pF)				DC to several kHz PWR, SW, Audio terminals, etc.

## Applications

- Smart phone**
  - [Key/SW/LED]
  - [Condenser microphone]
  - [Audio (Mic, Speaker, Head set)]
  - [I/O, USB]
  - [Battery pack]

- USB1.1/2.0 lines**

- IEEE1394 lines**

- HDMI lines**

## Multilayer Varistors EZJZ, EZJP, EZJS series / Performance and testing

### Performance and testing methods

Characteristics	Specifications	Testing method															
Standard test conditions		Electrical characteristics shall be measured under the following conditions. Temp. : 5 to 35 °C, Relative humidity : 85 % or less															
Varistor voltage	To meet the specified value	The Varistor voltage is the voltage ( $V_C$ or $V_{CmA}$ ) between both end terminals of a Varistor when specified current ( $CmA$ ) is applied to it. The measurement shall be made as quickly as possible to avoid heating effects.															
Maximum allowable voltage	To meet the specified value	The maximum DC voltage that can be applied continuously to a varistor.															
Capacitance	To meet the specified value	Capacitance shall be measured at the specified frequency, bias voltage 0 V, and measuring voltage 0.2 to 2.0 Vrms															
Maximum peak current	To meet the specified value	The maximum current measured (Varistor voltage tolerance is within $\pm 10\%$ ) when a standard impulse current of 8/20 $\mu$ seconds is applied twice with an interval of 5 minutes.															
Maximum ESD	To meet the specified value	The maximum ESD measured (while the varistor voltage is within $\pm 30\%$ of its nominal value) when exposed to ESD 10 times (five times for each positive-negative polarity) based on IEC61000-4-2.															
Solder ability	To meet the specified value	The part shall be immersed into a soldering bath under the conditions below. Solder : Sn-3.0Ag-0.5Cu Soldering flux : Ethanol solution of rosin (Concentration approx. 25 wt%) Soldering temp. : 230 $\pm$ 5 °C Period : 4 $\pm$ 1 s Soldering position : Immerse both terminal electrodes until they are completely into the soldering bath.															
Resistance to soldering heat	$\Delta V_C/V_C$ : within $\pm 10\%$	After the immersion, leave the part for 24 $\pm$ 2 hours under the standard condition, then evaluate its characteristics. Soldering conditions are specified below: Soldering conditions : 270 °C , 3 s / 260 °C , 10 s Soldering position : Immerse both terminal electrodes until they are completely into the soldering bath.															
Temperature cycling	$\Delta V_C/V_C$ : within $\pm 10\%$	After repeating the cycles stated below for specified number of times, leave the part for 24 $\pm$ 2 hours, then evaluate its characteristics. Cycle : 5 cycles <table border="1" style="margin-left: auto; margin-right: auto; border-collapse: collapse;"> <thead> <tr style="background-color: #e0e0e0;"> <th style="width: 10%;">Step</th> <th style="width: 50%;">Temperature</th> <th style="width: 40%;">Period</th> </tr> </thead> <tbody> <tr> <td style="text-align: center;">1</td> <td>Max. Operating Temp.</td> <td style="text-align: center;">30<math>\pm</math>3 min</td> </tr> <tr> <td style="text-align: center;">2</td> <td>Ordinary temp.</td> <td style="text-align: center;">3 min max.</td> </tr> <tr> <td style="text-align: center;">3</td> <td>Min. Operating Temp.</td> <td style="text-align: center;">30<math>\pm</math>3 min</td> </tr> <tr> <td style="text-align: center;">4</td> <td>Ordinary temp.</td> <td style="text-align: center;">3 min max.</td> </tr> </tbody> </table>	Step	Temperature	Period	1	Max. Operating Temp.	30 $\pm$ 3 min	2	Ordinary temp.	3 min max.	3	Min. Operating Temp.	30 $\pm$ 3 min	4	Ordinary temp.	3 min max.
Step	Temperature	Period															
1	Max. Operating Temp.	30 $\pm$ 3 min															
2	Ordinary temp.	3 min max.															
3	Min. Operating Temp.	30 $\pm$ 3 min															
4	Ordinary temp.	3 min max.															
Biased humidity	$\Delta V_C/V_C$ : within $\pm 10\%$	After conducting the test under the conditions specified below, leave the part 24 $\pm$ 2 hours, then evaluate its characteristics. Temp. : 40 $\pm$ 2 °C Humidity : 90 to 95 %RH Applied voltage : Maximum allowable voltage (Individually specified) Period : 500+24/0 h															
High temperature exposure (dry heat)	$\Delta V_C/V_C$ : within $\pm 10\%$	After conducting the test under the conditions specified below, leave the part 24 $\pm$ 2 hours, then evaluate its characteristics. Temp. : Maximum operating temperature $\pm 3$ °C (Individually specified) Applied voltage : Maximum allowable voltage (Individually specified) Period : 500+24/0 h															

**Packaging methods (Taping)**

● Standard quantity

Series	Size code (inch size)	Thickness (mm)	Kind of taping	Pitch (mm)	Quantity (pcs/reel)
EZJZ, EZJP	Z(0201)	0.3	Pressed carrier taping	2	15000
	0(0402)	0.5			10000
	1(0603)	0.8	Punched carrier taping	4	4000
EZJS	1(0603)	0.8			4000
	2(0805)	0.8			5000
		1.25	Embossed carrier taping		2000

● 2 mm Pitch (Pressed carrier taping) Size 0201

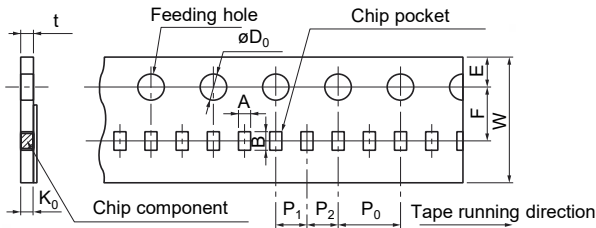

Unit : mm

Code	A	B	W	F	E	P <sub>1</sub>	P <sub>2</sub>	P <sub>0</sub>	øD <sub>0</sub>	t	K <sub>0</sub>
EZJZ EZJP	0.36 ±0.03	0.66 ±0.03	8.0 ±0.2	3.50 ±0.05	1.75 ±0.10	2.00 ±0.05	2.00 ±0.05	4.0 ±0.1	1.5 +0.1 0	0.55 max	0.36 ±0.03

● 4 mm pitch (Embossed carrier taping) Size 0805

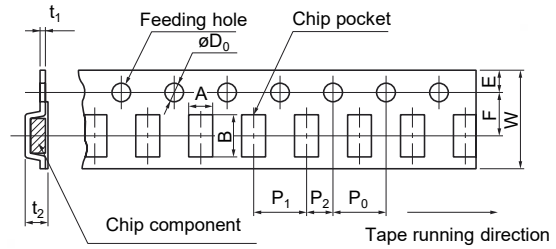

Unit : mm

Code	A	B	W	F	E	P <sub>1</sub>	P <sub>2</sub>	P <sub>0</sub>	øD <sub>0</sub>	t <sub>1</sub>	t <sub>2</sub>
EZJS	1.55 ±0.20	2.35 ±0.20	8.0 ±0.2	3.50 ±0.05	1.75 ±0.10	4.0 ±0.1	2.00 ±0.05	4.0 ±0.1	1.5 +0.1 0	0.6 max	1.5 max

● 2 mm Pitch (Punched carrier taping) Size 0402

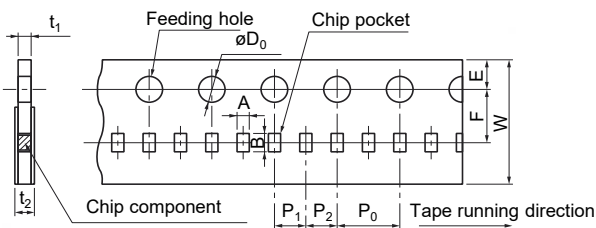

Unit : mm

Code	A	B	W	F	E	P <sub>1</sub>	P <sub>2</sub>	P <sub>0</sub>	øD <sub>0</sub>	t <sub>1</sub>	t <sub>2</sub>
EZJZ EZJP EZJS	0.62 ±0.05	1.12 ±0.05	8.0 ±0.2	3.50 ±0.05	1.75 ±0.10	2.00 ±0.05	2.00 ±0.05	4.0 ±0.1	1.5 +0.1 0	0.7 max	1.0 max

● Reel for taping

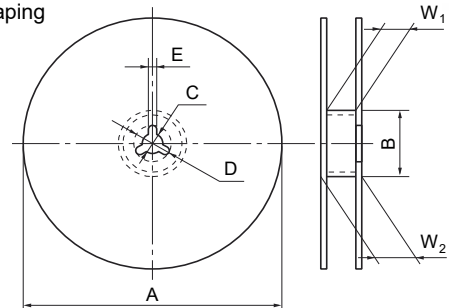

Unit : mm

Code	A	B	C	D	E	W <sub>1</sub>	W <sub>2</sub>
EZJZ EZJP EZJS	ø180 <sup>0</sup> <sub>-3</sub>	ø60.0 <sup>+1.0</sup> <sub>0</sub>	13.0 <sub>±0.5</sub>	21.0 <sub>±0.8</sub>	2.0 <sub>±0.5</sub>	9.0 <sup>+1.0</sup> <sub>0</sub>	11.4 <sub>±1.0</sub>

● 4 mm Pitch (Punched carrier taping)

Size 0603, 0805, 0504/2 Array

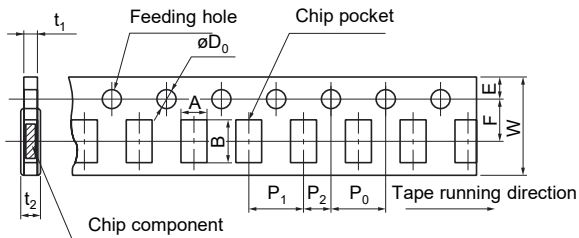

Unit : mm

Size code (inch size)	A	B	W	F	E	P <sub>1</sub>	P <sub>2</sub>	P <sub>0</sub>	øD <sub>0</sub>	t <sub>1</sub>	t <sub>2</sub>
1 (0603)	1.0 ±0.1	1.8 ±0.1	8.0 ±0.2	3.50 ±0.05	1.75 ±0.10	4.0 ±0.1	2.00 ±0.05	4.0 ±0.1	1.5 +0.1 0	1.1 max	1.4 max
S (0504 2 Array)	1.18 ±0.10	1.63 ±0.10									
2 (0805)	1.65 ±0.20	2.4 ±0.2									

● Leader part and taped end

Leader part

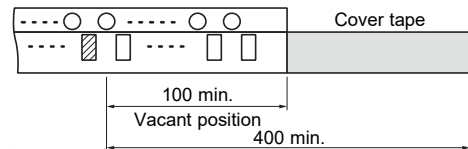

Tape end

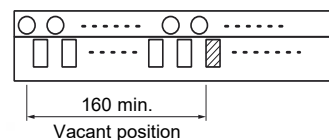

Unit : mm

## Safety Precautions

When using our products, no matter what sort of equipment they might be used for, be sure to confirm the applications and environmental conditions with our specifications in advance.

**Panasonic**  
INDUSTRY

Panasonic Industry Co., Ltd.  
Device Solutions Business Division

1006 Kadoma, Kadoma City, Osaka  
571-8506 Japan