

Outline:

- Low profile design makes it optional for surface mounting
- Exclusive square type closed magnetic core designed as an exclusive core is used, so it can be small
- Excellent impedance characteristics, making it great for suppressing common mode noise

Features:

- Core material: Ferrite
- Environmental: RoHS, Reach compliant, Halogen free
- Weight: 0.55g
- Moisture Sensitivity: Level (MSL) 1 (unlimited floor life at <30°C / 85% relative humidity).
- Operating temperature range: -40°C~+125°C (including coil's self temperature rise)
- Storage temperature range: -40°C~+125°C

Application:

- Measures against common mode noise in power lines for various DC power lines, multimedia devices and various electronic devices, including automotive power trains.

1 Electrical Characteristics

Part No.	Inductance (μH)	Impedance (Ω)	Leakage Inductance (nH)	D.C.R (m Ω)	Rated Current (A)	Rated Voltage (V)	Frequency Range (MHz)
		※1	※2		※3		
		Min	Typical	Max	Max	Max	
CSTA0950RB-100	10.0 \pm 30%	200	40.0	70.0	1.60	80.0	20.0~300
CSTA0950RS-100	10.0 \pm 30%	200	800	70.0	1.60	80.0	20.0~300
CSTA0950RB-250	25.0 \pm 30%	600	150	110	1.00	80.0	20.0~150
CSTA0950RS-250	25.0 \pm 30%	600	1,000	110	1.00	80.0	20.0~150
CSTA0950RB-400	40.0 \pm 30%	800	220	250	0.90	80.0	20.0~100
CSTA0950RS-400	40.0 \pm 30%	800	1,500	250	0.90	80.0	20.0~100
CSTA0950RB-510	51.0 \pm 30%	1,000	220	160	1.00	80.0	20.0~100
CSTA0950RS-510	51.0 \pm 30%	1,000	1,900	160	1.00	80.0	20.0~100
CSTA0950RB-251	250 \pm 50%	600	120	130	1.20	80.0	3.00~20.0
CSTA0950RB-501	500 \pm 50%	1,000	220	150	1.00	80.0	1.00~20.0
CSTA0950RB-102	1,000 \pm 50%	1,500	250	310	0.80	80.0	1.00~15.0
CSTA0950RB-202	2,000 \pm 50%	3,000	350	420	0.60	80.0	1.00~5.00
CSTA0950RB-472	4,700 \pm 50%	4,000	550	750	0.50	80.0	0.30~3.00
CSTA0950RB-652	6,500 \pm 50%	5,000	800	950	0.40	80.0	0.30~2.00

All data is tested on 25°C ambient temperature

1. Impedance measure condition reference frequency range.
2. Leakage inductance is for L1 and is measured with L2 shorted.
3. Rated current: the actual value of DC current when the temperature rise is $\Delta T 40^\circ\text{C}$ ($T_a = 25^\circ\text{C}$)

2 Product Dimensions (mm)

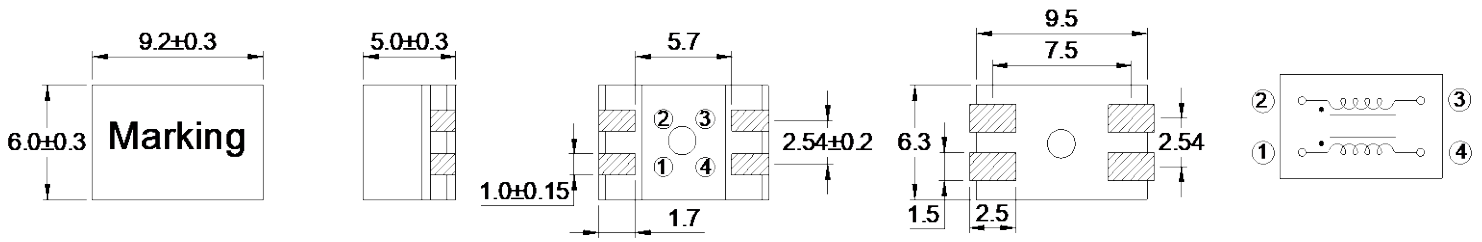

Typical Land Pattern

Schematic

3 Impedance vs Frequency Curve

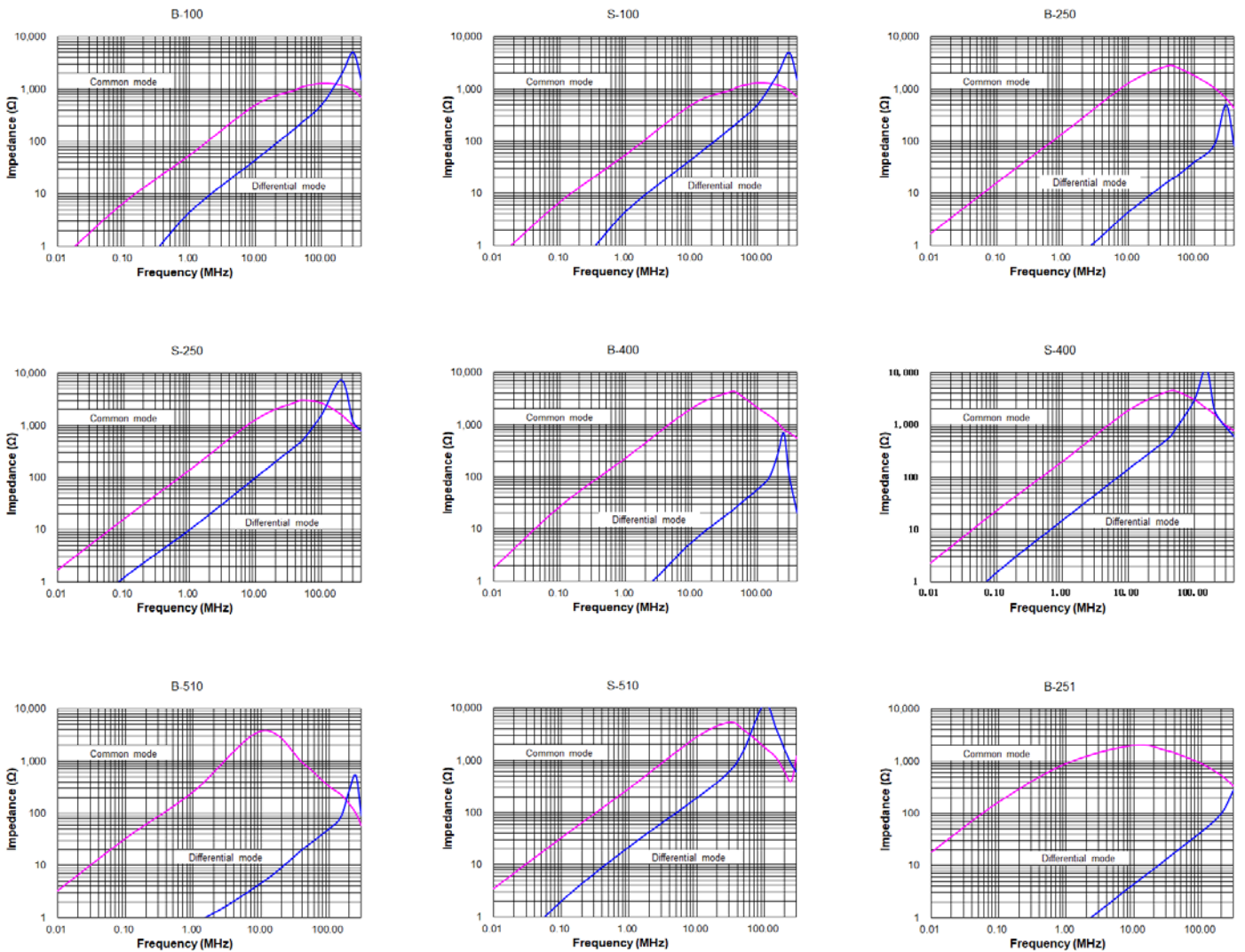

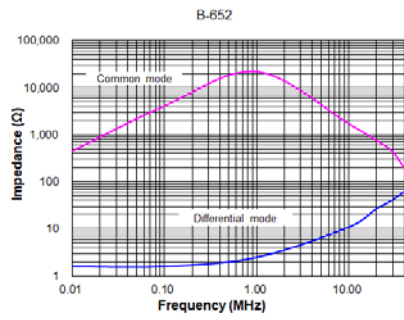
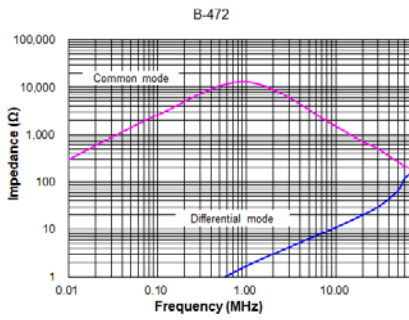
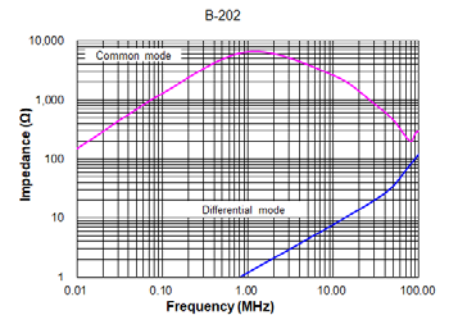
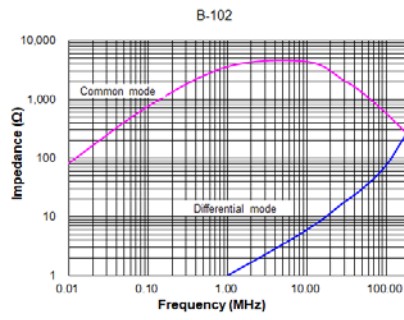
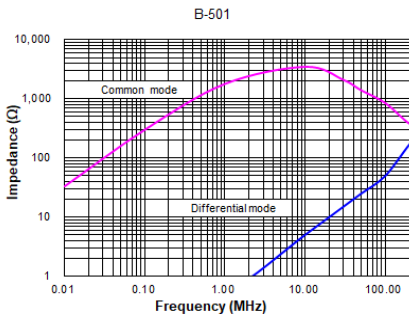

4 Packing Specification

4.1 Carrier Tape Dimensions (mm)

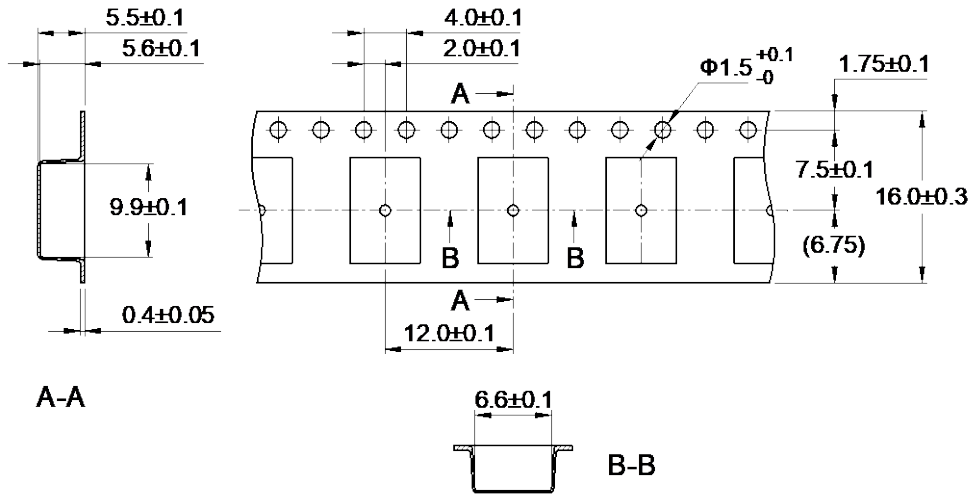

※ Packing is referred to the international standard IEC 60286-3.

4.2 Reel Dimensions (mm)

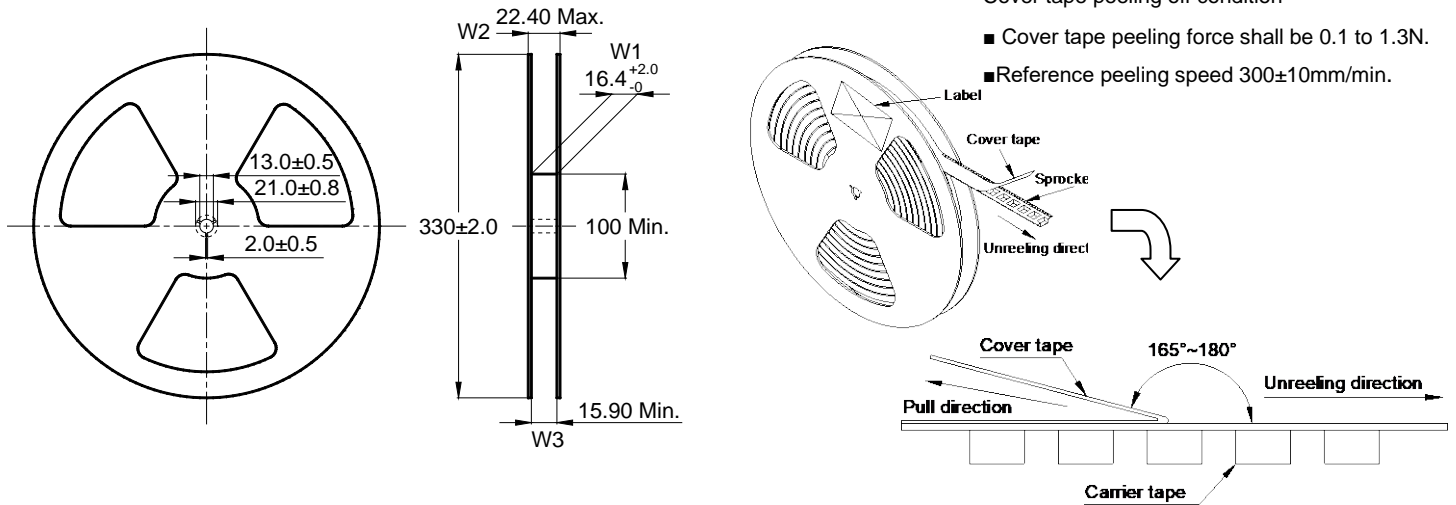

4.3 Carton Dimensions and Packing Quantity

■ Inner Carton: 340×340×95mm

■ Out Carton : 360×360×370mm

Product Series	Quantity / Reel	Inner Carton Quantity	Out Carton Quantity
CSTA0950R	1000pcs	(1000×3) = 3000pcs	(3000×3) = 9000pcs

5 Soldering Specification

5.1 Reflow Profile for SMT Components

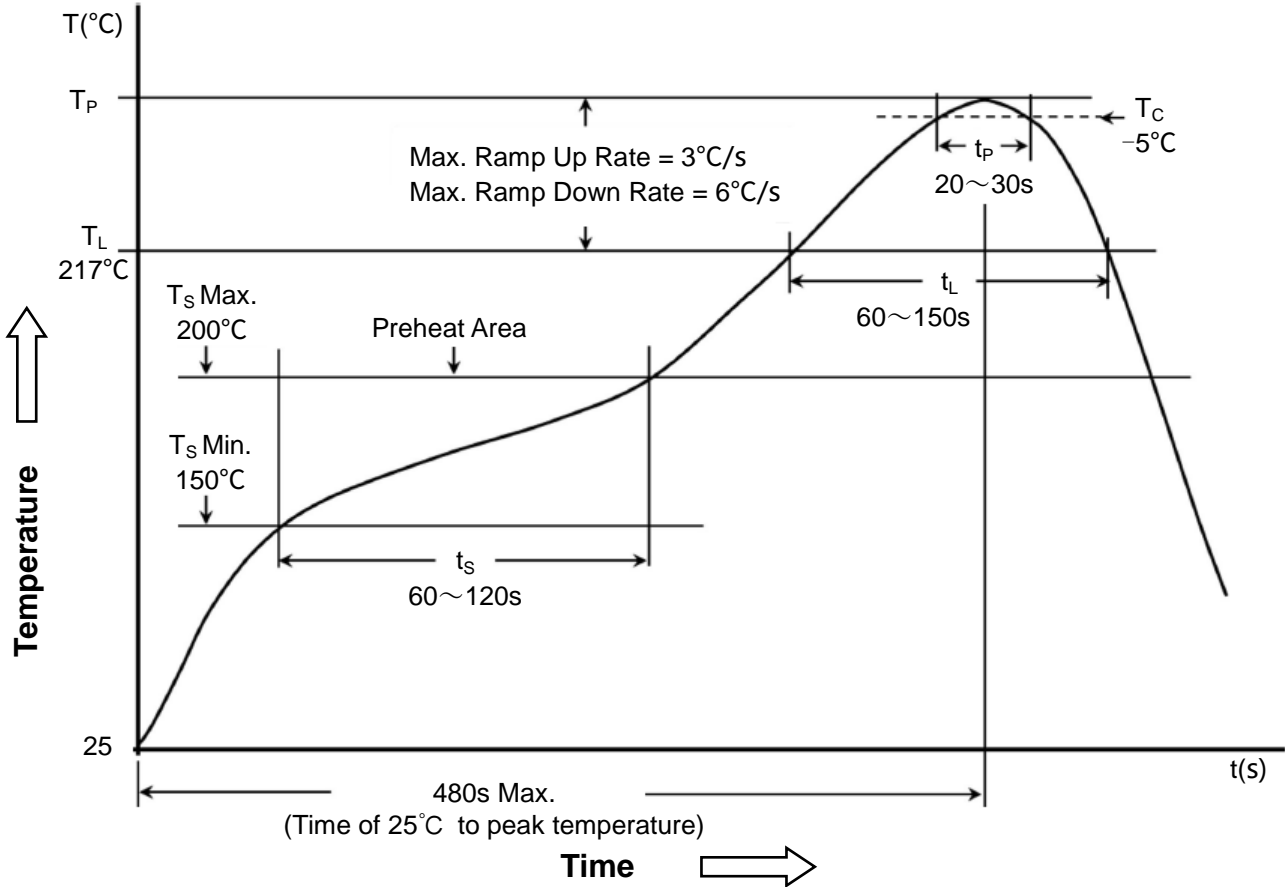

5.2 Classification of Peak Package Body Temperature (Tp)

	Package Thickness	Package Volume		
		<350 mm ³	350~2000 mm ³	>2000 mm ³
PB-Free Assembly	<1.6mm	260°C	260°C	260°C
	1.6~2.5mm	260°C	250°C	245°C
	≥2.5mm	250°C	245°C	245°C

※ Reflow is referred to standard IPC/JEDEC J-STD-020D.

6 Notice of Use

- 6.1 Special remind:Circuit design, component placement, PCB size and thickness, cooling system and etc. all will affect the product temperature. Please verify the product temperature in the final application.
- 6.2 Product in packing storage condition:temperature 5~40°C, RH≤70%.
If taking out for use, the remaining products should be sealed in plastic bags and preserved in accordance with the above conditions, to avoid oxidation of terminals (electrodes), affecting soldering status.
- 6.3 A storage of Codaca Electronic products for longer than 12 months is not recommended, Within other effects, the terminals may suffer degradation, resulting in bad solderability. Therefore, all products shall be used within the period of 12 months based on the day of shipment.
- 6.4 Do not keep products in unsuitable storage conditions, such as areas susceptible to high temperatures, high humidity, dust or corrosion.
- 6.5 Always handle products with care.
- 6.6 Don't touch electrodes directly with bare hands as oil secretions may inhibit soldering.
Always ensure optimum conditions for soldering.
- 6.7 When this product will be used on a similar or new project to the original one,
sometimes it might be unable to satisfy the specifications due to different condition of usage.
- 6.8 This inductor itself does not have any protective function in abnormal condition, such as overload, short-circuit, open-circuit conditions, etc. Therefore, it shall be confirmed that there is no risk of smoke, fire, dielectric withstand voltage, insulation resistance, etc., or use in abnormal conditions protective devices or protection circuit in the end product.
- 6.9 Hi-Pot test with higher voltage than spec value will damage insulating material and shorten its life.
- 6.10 If using in potting compound, the magnet wire coating might be damaged, please consult with us.
- 6.11 Refrain from rinsing coils. If necessary, please consult with us.
- * 6.12 Codaca Electronic products without "V" prefix are qualified for industrial product requirement , and with "V" prefix are qualified for AEC-Q200, but it doesn't mean that Codaca Electronic products can absolutely meet specific industry norms and quality test standards in automotive electronics or more strict application fields . Codaca Electronic will be exempted from being responsible for the consequences of using Codaca products in automotive electronic or higher application field related to safety when without being aware of it.